

Contents

EC Declaration of Conformity	2
Operator safety	3
Description	4
Components	5
Connection of HP 3570 display	6
Display readout information	7
Menus	9
Using the keyboard	9
Keystroke menu tree chart for HP 3570 version 1.5	10
[01] Flow calibration - theoretical	11
[02] Flow calibration - Tank method	12
[03] Flow calibration - Nozzle method	13
[04] Speed calibration - theoretical	14
[05] Speed calibration - practical	15
[06] Regulation constant	15
[07] Revolutions readout of P.T.O.	16
[08] Selection of unit (liquid or solid matter)	17
[09] Adjustment of work width	18
[10] Location of speed transducer	19
[11] HARDI LINK	20
Areameter and HP 3570	20
Mistblower and HP 3570	21
Storage	21
Fault finding	21
Error codes during start-up	21
Fuse replacement in HP 3010 tractor junction box	22
Coaxial cables and short circuits	22
Fine tuning the flow constant - PPU	22
Testing flow transducer (ref. no. 728816)	23
Testing speed transducer (ref. no. 729058)	23
Technical specifications	24
Assembly	25
Chart for recording values	31
Spare parts	33

HARDI PILOT 3570 Monitor

675044-GB-96/9

HARDI INTERNATIONAL A/S reserve the right to make changes in design or to add new features without any obligation in relation to implements purchased before or after such changes.



EC Declaration of Conformity

Manufacturer,

HARDI INTERNATIONAL A/S
Helgeshøj Allé 38
DK 2630 Taastrup
DENMARK

Importer,

declare that the following product;

.....
.....

Adhere extra shipping package labels to inside cover.


was manufactured in conformity with the provisions in the EMC directive 89/336/EEC, EN 50081-1 (generic emission) and EN 50082-1 (generic immunity).

Taastrup 1/9/96











Erik Holst

Managing Director
HARDI INTERNATIONAL A/S

Operator safety

Watch for this symbol . It means NOTE, WARNING, CAUTION. Your safety is involved so be alert!

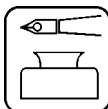
Note the following recommended precautions and safe operating practices.

-  Read and understand this instruction book before using the equipment. It is equally important that other operators of this equipment read and understand this book.
-  Disconnect electrical power before disconnecting the display or servicing.
-  Press the keys with the underside of your finger. Avoid using your fingernail.
-  If an arc welder is used on the equipment or anything connected to the equipment, disconnect power before welding.
-  Do not service or repair the equipment whilst it is operating.
-  Test with clean water prior to filling with chemicals.
-  Always replace all safety devices, covers or shields immediately after servicing.
-  Keep children away from the equipment.
-  Do not use a high pressure cleaner to clean the electronic components.
-  If any portion of this instruction book remains unclear after reading it, contact your HARDI dealer or HARDI service personnel for further explanation before using the equipment.





We congratulate you for choosing a HARDI plant protection product. The reliability and efficiency of this product depend on your care. **Read and pay attention** to this instruction book. It contains information for the efficient use and long life of this quality product.



Description

The HARDI PILOT 3570 Monitor is a data processor system for use in agricultural and horticultural production. The main components are:

- HP 3570 display
- HP 3010 tractor junction box
- Transducers (sensors)

Data and power connection between the display and junction box is done with just one coaxial cable so that all excessive wiring is avoided. The components communicate via the HARDI LINK system.

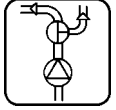
The HP 3570 display is very compact for easy placement in the tractor cabin and can be fitted directly on to a flat surface. It is illuminated internally so readout is possible even for night-time work. HP 3570 can have the following readouts:

- Driving speed
- Area treated
- Revolutions
- Actual application rate
- Flow rate

The HP 3010 tractor junction box is fitted to the tractor. It supplies HARDI LINK with current and has the connection points for the transducers. A fuse on the current inlet protects the system from reverse polarity and overload.

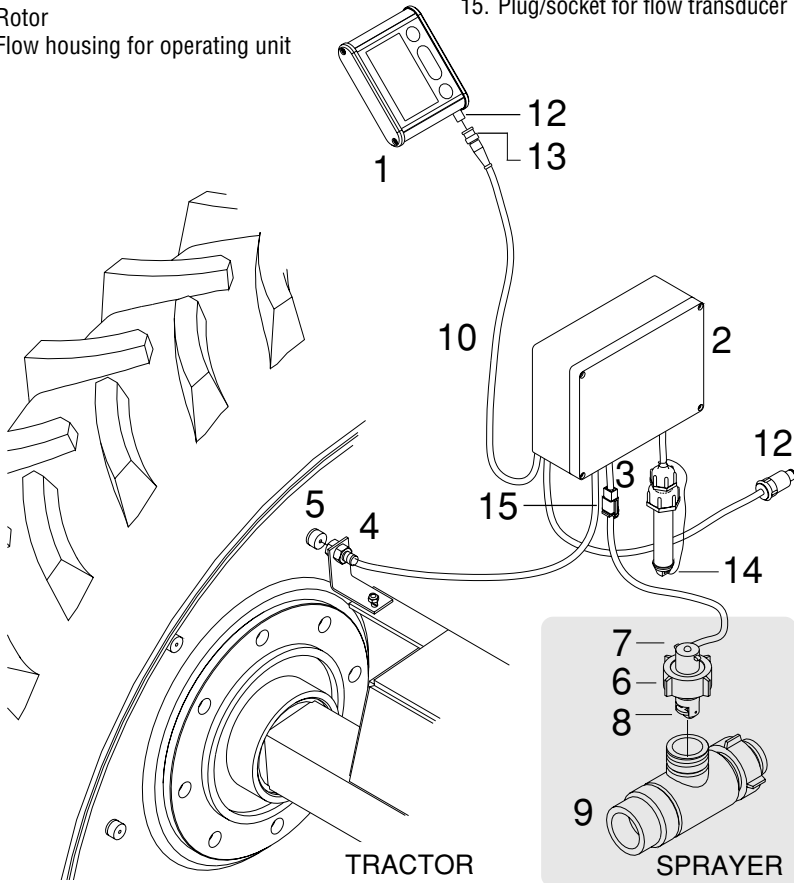
The transducers that can be connected are speed transducer, flow transducer, P.T.O. r/min transducer and area switch. The components utilised are chosen for long service life and good signal quality. Speed, area switch and r/min transducer is the same component. The flow transducer has a diode built into the housing to aid servicing. As the rotor turns, the diode will flash thereby indicating it functions.

HARDI PILOT has a non-volatile memory (contains no batteries) which simplifies storage. Factory default constants and values are already programmed into the system. The materials and electronics for the components have been developed to last many years under agricultural conditions.



Components

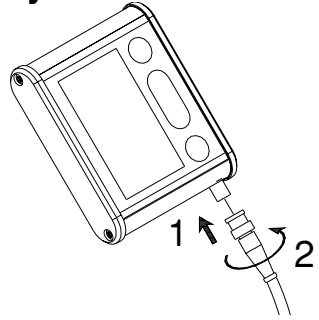
- | | |
|---|---|
| <ol style="list-style-type: none"> 1. HP 3570 display 2. HP 3010 tractor junction box 3. Fuse 4. Speed transducer 5. Magnets 6. Flow transducer 7. Diode 8. Rotor 9. Flow housing for operating unit | <ol style="list-style-type: none"> 10. Coaxial cable 11. Power cable 12. BNC connector jack 13. BNC connector plug 14. BNC cover (not used) 15. Plug/socket for flow transducer |
|---|---|





Connection of HP 3570 display

NOTE: To avoid a short circuit, the power must be disconnected before attaching the BNC connector plug to the display connector jack. The connector has a bayonet fitting. To attach, locate guide groove, push and turn.



Start-up of HP 3570 display

When the power is connected, a test is carried out to check all segments and symbols in the graphic display. During the test the individual segments are switched on one by one. In addition, all four figures in the digital displays are counted, i.e. 0000, 1111 etc. up to 9999.

While the display test is being carried out, the internal electronics are also tested.

When the test is concluded, all symbols light up briefly after which everything is switched off and a version number is shown. The version number explains which programme version the display unit contains. HP 3570 concludes the test by showing the total work (boom) width and the number of sections which is one for this equipment. HP 3570 is now tested and is ready to operate.

NOTE: Use of sunglasses will reduce visibility of the graphic display.

NOTE: Text or symbols found or seen on the display is shown inside the brackets; [X]

Metric units and US units are separated by a slash; Metric / US

For example:

[Ver]	[Ver]
[1.x]	[1.x]

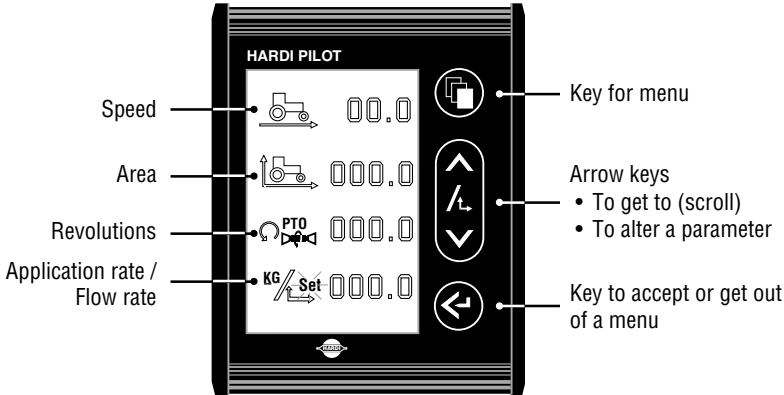
Total work width

12 metre	40 feet
----------	---------

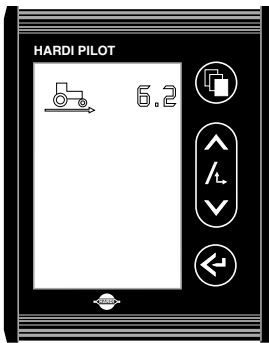
[Size]	[Size]
[1200]	[40']
[Sect]	[Sect]
[1]	[1]

Display readout information

HP 3570 display, keyboard and syntax



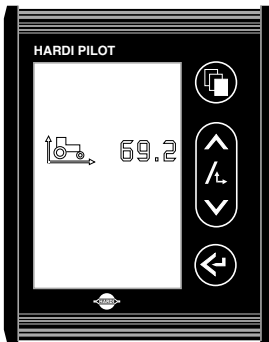
Reading driving speed



The speed is read off with one decimal place. The speed transducer is placed on the tractor. See “Menus, [1 0] Location of speed transducer”.

Speeds under 0.5 km / 0.3 mph per hour are shown as 0.0. The travelling speed is updated at least twice a second.

Reading area treated



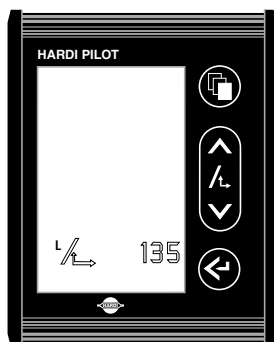
The area display shows a summation of the area treated.

The area display calculates as long as there is simultaneous speed and flow or alternatively, speed and a signal from the areameter. The area is shown up to 999.9 with one decimal place. After this, only whole area units are shown.

The treated area is memorised when HP 3570 is switched off.



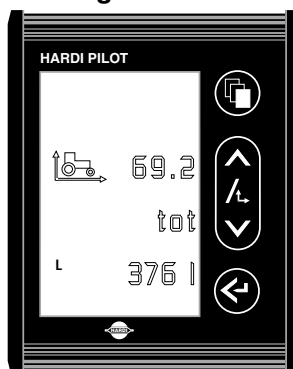
Actual application rate




The actual quantity applied per area unit is shown when driving.




On the same display area, the flow rate is shown when not driving.

Reading of total area treated and total volume sprayed





The area treated with the corresponding volume sprayed since the last reset can be read off. Press accept key [] briefly. For about 5 seconds, the totals for the area treated and the volume sprayed since the last reset will be shown in the display.

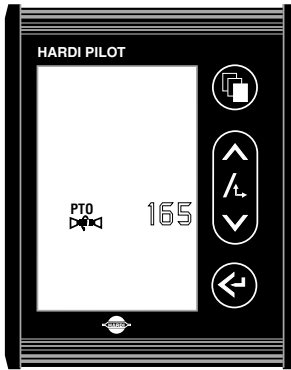
NOTE: The total area treated and total volume sprayed is updated in the non-volatile memory for every 0.5 hectares / 1 acre.

The display can show a maximum of 9999 units sprayed. If this is exceeded [] / [] and [] will be shown.

Reset of total area treated and total volume sprayed

Area and volume sprayed can be reset by pressing the accept key [] continually. After approx. 5 seconds, the totals are zeroed. As long as the area and liquid symbols are flashing in the display, it is possible to regret, by releasing the accept key [].

Reading revolutions



In the revolutions display, P.T.O. revolutions can be read. For selection see “Menus, [07]”. **NOTE:** It is only possible to read revolutions if a transducer has been installed. A [-] will be shown in the display if the transducer is not connected.





Reading P.T.O. revolutions




The symbol for the relevant transducer is shown on the screen.

Menus

Using the keyboard

Selection of the above parameters are carried out in the menus []. During changes in the menus, the display will flash [SET] and a menu number.

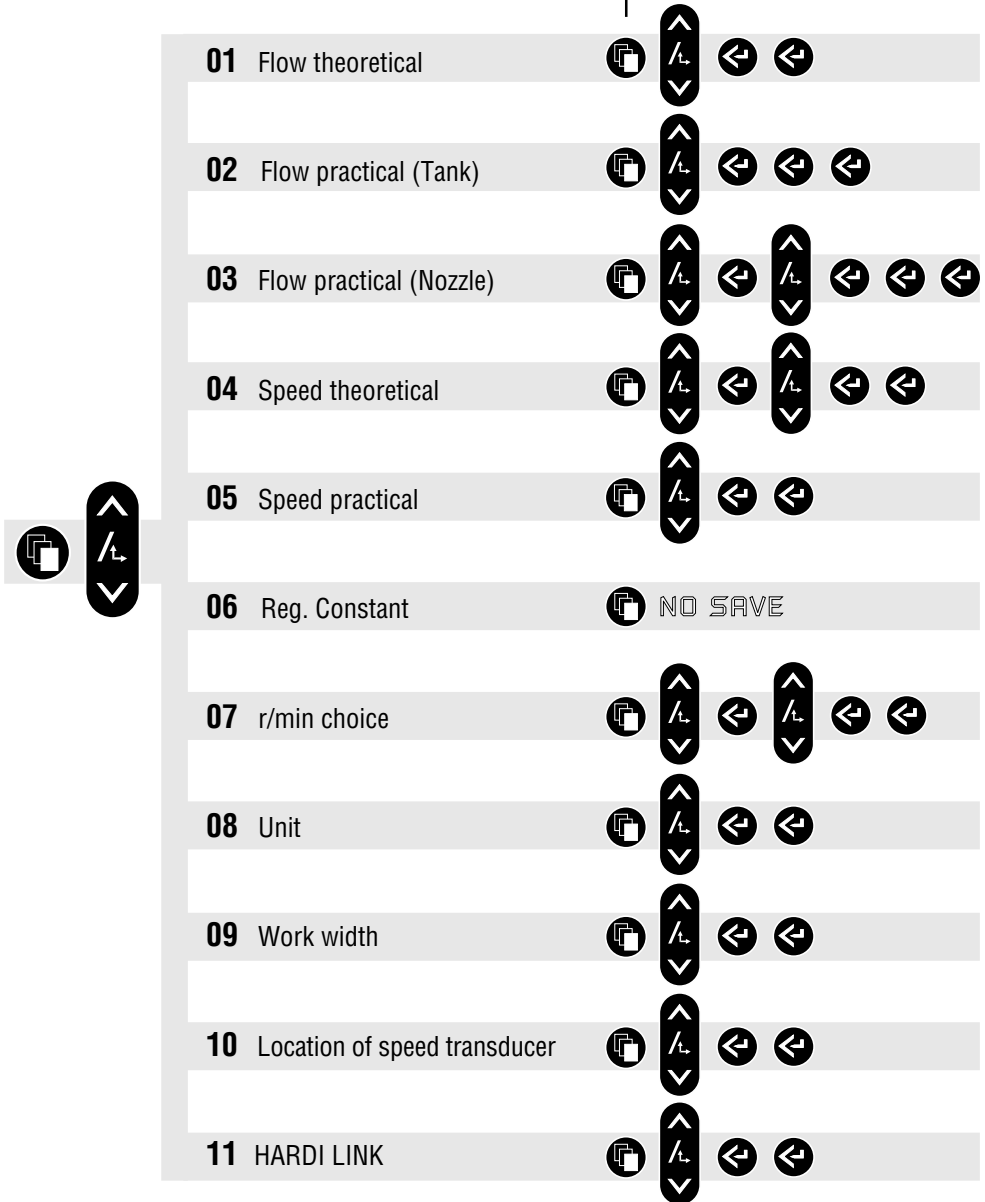
The menus can be scrolled to and fro with the arrow keys [].

When the chosen menu is shown on the display, press the menu key [] for more than 3 seconds to open the menu. The display will then change to a new picture so further selections can be made between different set-ups or parameters. When modifying a parameter, prolonged pressure on the arrow key will cause the data shown on the display to alter faster. After the parameter is modified, press the accept key []. The display then changes back to the previous picture. Press the accept key [] until the display returns to the main display.

All parameters in menu 01 to 11 are saved in the display's memory and are not lost when the power is disconnected.

Keystroke menu tree chart for HP 3570 version 1.5

Press more than 3 seconds





Calibration of flow transducer

The flow transducer can be calibrated theoretically or with two practical methods. For the sake of accuracy, the practical methods are preferred. Practical calibration is done with clean water. The Tank method in menu 02 is more time consuming, but is more accurate than the Nozzle method in menu 03.

When changing to nozzles with more than a 100% increase or decrease in output, it is recommended to re-calibration the flow transducer.

Calibration is recommended to be carried out at least once during the spraying season.

Use the chart at the back of the book to record the values.

[01] Flow calibration - theoretical

During theoretical flow calibration in menu 01, the number of pulses per unit [PPU] are shown on the display. For example, [L 120.0] indicates the number of pulses which theoretically come from the flow transducer whilst 1 litre of liquid passes through.

Method

1. Open menu 01.
2. Use arrow key to adjust PPU value.
3. Use accept key to close the menu and return to the main display picture.

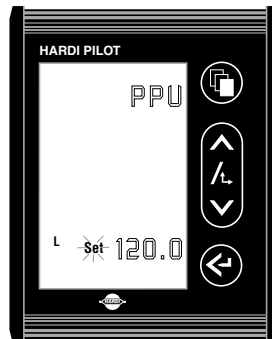
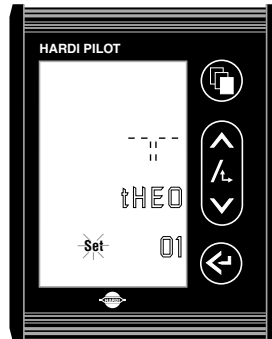
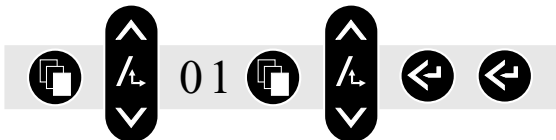
Approximate PPU values for different flow housings are as follows:

	colour code	Metric	US gal.
BK housing	white	120.0 PPU	455.0 PPU
EC housing	white	118.0 PPU	447.0 PPU
EC housing for S/67	white	128.0 PPU	485.0 PPU
EC housing	black	59.0 PPU	223.0 PPU

White colour code = 13.5 mm / 5/8" orifice.

Black colour code = 20.0 mm / 7/8" orifice.

Keystrokes





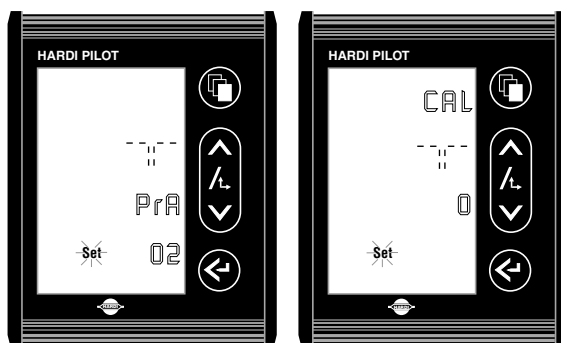
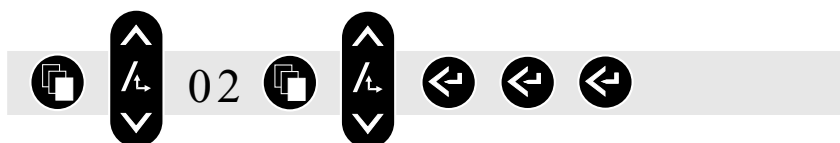
[02] Flow calibration - Tank method

During practical flow calibration in menu 02, the tank is partly emptied through the nozzles. Whilst emptying, the display calculates the quantity emptied on the basis of the actual calibration value (PPU). The quantity displayed is compared with the quantity actually dosed. This can be according to the tank contents level indicator or by weight difference before and after. The quantity displayed is corrected to read the quantity actually dosed.

Method

1. Place the tank on level ground and fill up with water until the level reaches a unique mark on the tank contents level indicator, e.g. 1000 litre / 300 gallons.
2. Open all boom sections.
3. Open menu 02 and turn the main ON/OFF valve on. [Open All] will be displayed if there is no flow. The display unit will then begin to count the volume being emptied through the nozzles.
4. When for example, 600 litre / 200 gallons have been emptied out, as shown by the tank contents level indicator, the main ON/OFF valve can be turned off.
5. Correct the volume shown on the display with the arrow key to read the volume shown on the tank contents level indicator. The display will briefly show the new calibration value PPU (pulses per unit) when returning to the main display picture.

Keystrokes



[03] Flow calibration - Nozzle method

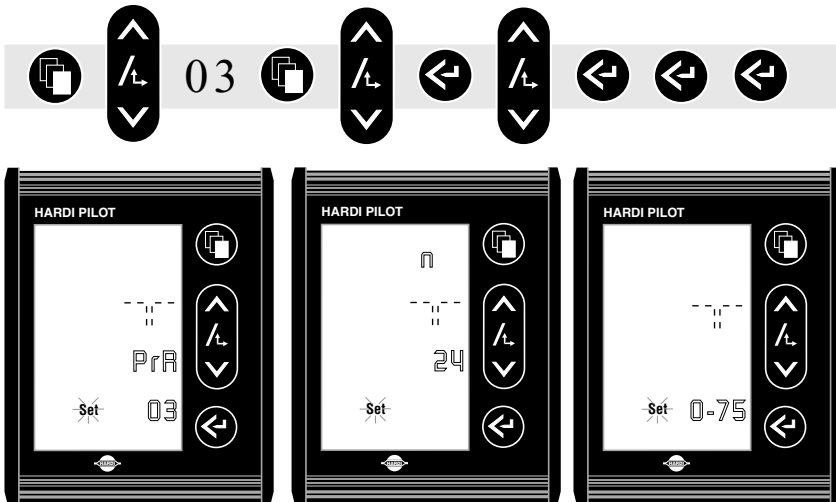
During practical flow calibration in menu 03, the individual nozzle output on the display is compared to the actual individual nozzle output. The output displayed is corrected to read the actual output. For correct calibration it is necessary to know the number of nozzles on the boom.



Method

1. Open all boom sections.
2. Open menu 03. [\square] indicates number of nozzles and this is corrected with the arrow key to read the actual number of nozzles to spray.
3. Turn the main ON/OFF valve on. [Open All] will be displayed if the main valve is turned off.
4. The display unit will then show the individual nozzle output per minute.
5. Using a HARDI calibration jug, check the actual nozzle output per minute. It is recommended that an average of several nozzles be taken.
6. Correct the output shown on the display with the arrow key to read the average output measured with the calibration jug. The display will briefly show the new calibration value PPU (pulses per unit) when returning to the main display picture.

Keystrokes





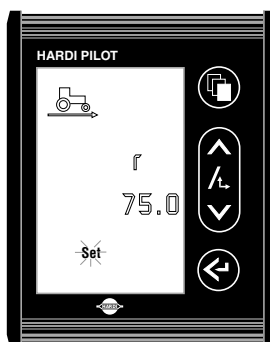
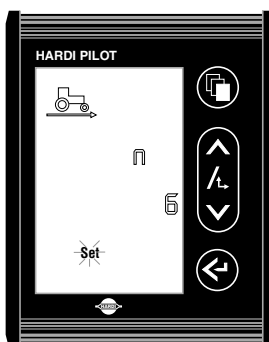
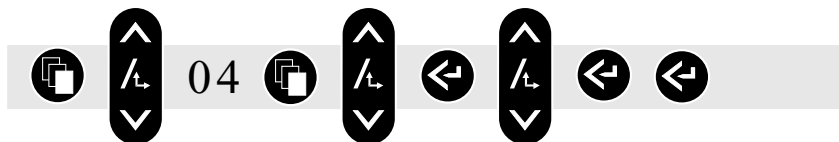
[04] Speed calibration -theoretical

During theoretical speed calibration in menu 04, first the number of magnets on the wheel is indicated, followed by the radius of the wheel. HP 3570 then calculates the wheel's circumference and the number of pulses per rotation.

Method

1. Open menu 04.
2. [n] indicates number of magnets and this is corrected with the arrow key to read the actual number of magnets. Press the accept key.
3. [r] indicates radius. The radius is measured from the earth up to the middle of the hub cap. The wheel radius is corrected with the arrow key to read the actual measured radius.

Keystrokes



[05] Speed calibration - practical

Practical calibration of speed in menu 05 is done by driving a measured distance and correcting the display so that the actual and the calculated distances are the same.

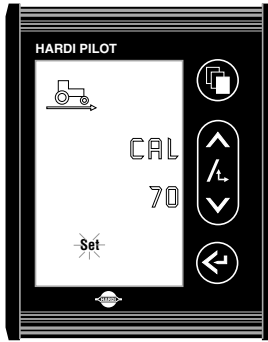
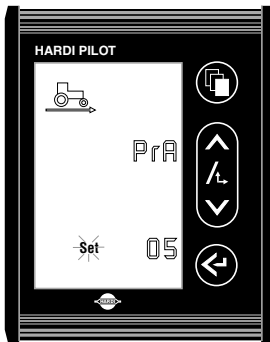
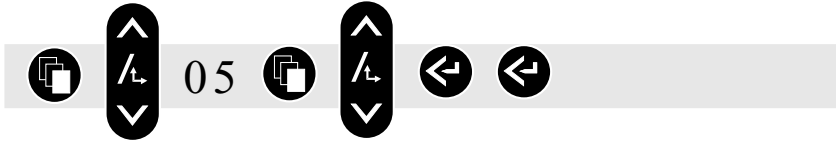
Theoretical speed calibration should be carried out before practical speed calibration.

Calibration should take place in the field with a half full tank and normal working tyre pressure in order to obtain the wheel's real "working radius".

Method

1. Measure a distance not less than 75 metres / 250 feet.
2. Park the tractor at the start of the measured distance.
3. Open menu 05. Drive the measured distance.
4. Correct the distance shown on the display with the arrow key to read the actual distance.

Keystrokes



[06] Regulation constant

Not relevant to this system. The [NO SAVE] will appear on the display.






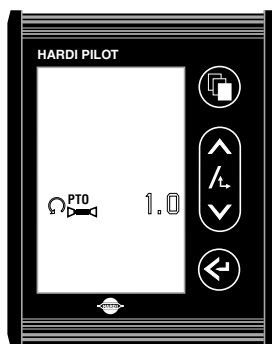
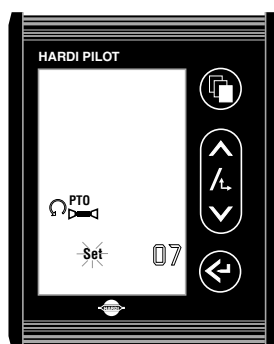
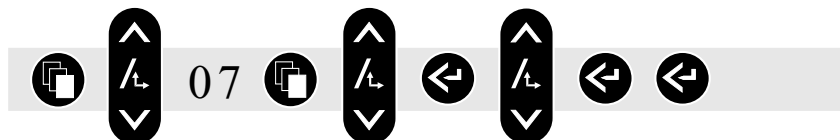
[07] Revolutions readout of P.T.O.

In menu 07, it is possible to see the revolutions on the P.T.O.. One magnet is usually fitted to the shaft. The display will also show a symbol for the TWIN fan and an auxiliary shaft but this is not relevant to this system.

Method

1. Open menu 07.
2. Choose the [] symbol with the arrow key and press accept key.
3. Now a value of [1.0] is shown. This indicates that one pulse will come per revolution. If the revolutions, for example, on a fertiliser disc are required, it is necessary to alter the pulse number per shaft revolution with the arrow key to get disc revolutions.

Keystrokes



[08] Selection of unit (liquid or solid matter)

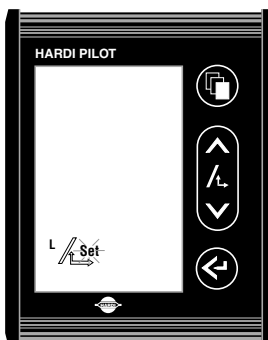
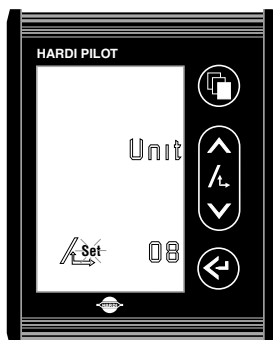
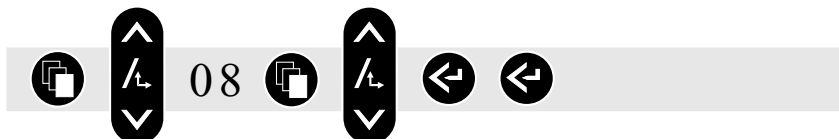
HP 3570 is predisposed as a monitor for spreading fertiliser and it is therefore possible to choose between dosage of liquid or solid matter.



Method

1. Open menu 08.
2. Use the arrow key to choose the unit.

Keystrokes





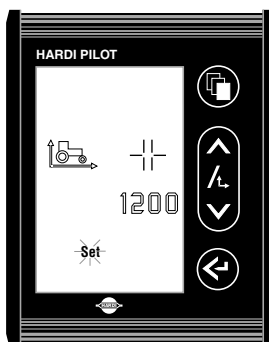
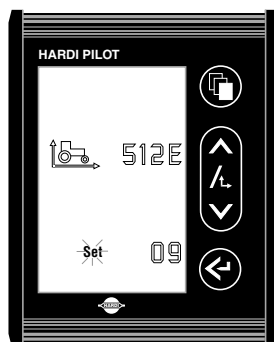
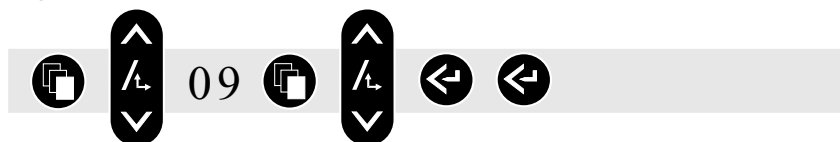
[09] Adjustment of work width

Correct total work width is necessary to calculate dosage and area covered.

Method

1. Open menu 09.
2. Use the arrow key to increase or decrease work width.

Keystrokes



[10] Location of speed transducer

[trct] indicates that the transducer signal is coming from the tractor.

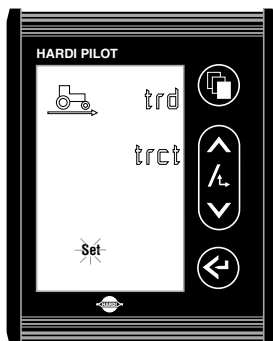
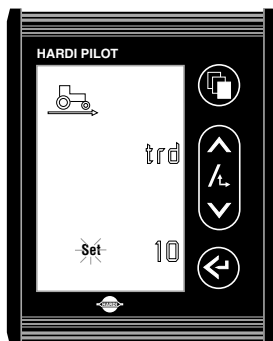
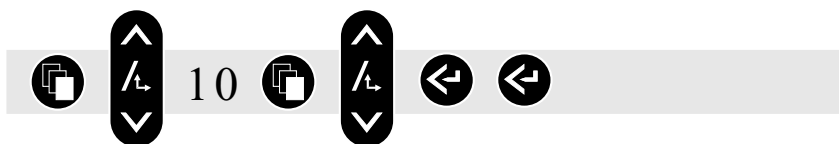
[SPRA] indicates that the transducer signal is coming from the sprayer. The transducer location must be on [trct] otherwise there will be no speed readout.

NOTE: Do not confuse the abbreviation for transducer [trd] with [trct].

Method

1. Open menu 10.
2. Use the arrow key to select [trct]

Keystrokes





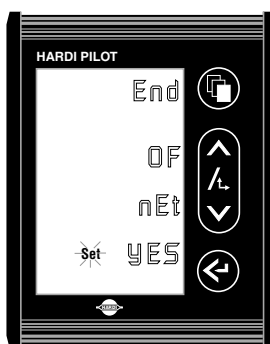
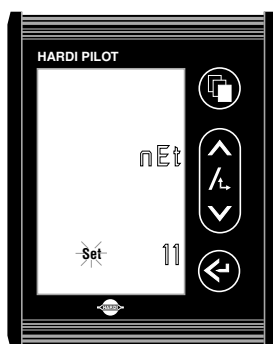
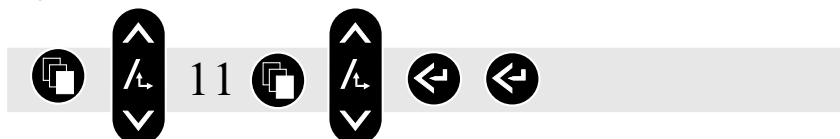
[11] HARDI LINK

HARDI LINK needs to know which is the last unit on the communication net so that no electrical interference occurs. Last unit is understood as meaning there are no more HP 3XXX units on the cable after the display. (The display must not be equipped with a coaxial T-link).

Method

1. Open menu 11.
2. Use the arrow key to choose [Yes].

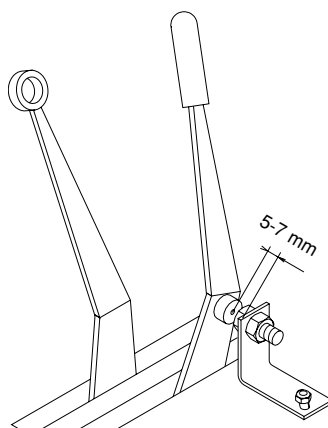
Keystrokes



Areameter and HP 3570

Points to note if the system is fitted with an areameter.

- The system will register covered area when the south side of the magnet is located directly in front of the areameter transducer.
- When the system is used with a flow transducer, the areameter must be disabled. This can be done by preventing the magnet from positioning in front of the transducer or by disconnecting the transducer.



Mistblower and HP 3570

Points to note if the system is used on a mistblower.

- Work width is the same as the spray width of the mistblower.
- Use the Tank method to calibrate the flow transducer. See “Menu, [0 2] Flow calibration - Tank method.”
- Blower fan revolutions can be read if the gear ratio is know. See “Menu, [0 7] Revolutions readout of P.T.O.”

Storage

When not in use, disconnect the power supply. This will stop the system from using power.

The display should be protected from moisture and should be removed if the tractor does not have a cabin.

Fault finding

Error codes during start-up

At start-up, the following error codes may be shown:

[LINE FAIL] This indicates that the unit can “see” signals on HARDI LINK, but cannot interpret them.

Action: Check the system is correctly terminated. See “Menu, [1 1] HARDI LINK”. When this check is finished, re-start the system.

[No data] This means that there is no signal on HARDI LINK.

Action: Check all the coaxial cable connections as well as the termination in the display See “Menu, [1 1] HARDI LINK” and then re-start the system.

[NO SAVE] This error indicates that the modified parameters in the set-up have not been saved in the display memory.

Action: Check whether the function selected is accessible.

[== == ==] If the value 9999 is exceeded, the display will indicate this with 12 horizontal dashes (overflow).





Fuse replacement in HP 3010 tractor junction box

A quick acting fuse located on the HP 3010 tractor junction box protects the system.

Fuse (HARDI ref. no. 261617) 4.0 Amp Ø 6, 5 x 32 F. Quick acting

Coaxial cables and short circuits

To check a cable:

1. Remove the cable shroud and inspect for cuts. There must be no cuts in the cable.
2. With an ohmmeter, check there is no circuit between the inner wire and the outer shield.
3. Whilst twisting the cable at the BNC fittings with the ohmmeter still connected, check there is no circuit.

If the cable short circuits, remove the BNC fitting and refit a new one. If this is not possible, replace the whole cable.

Fine tuning the flow constant - PPU

Calibration of the flowmeter is carried out with clean water but small changes may occur when adding pesticides or fertiliser. This will effect the final readings. This is typically noted when the volume displayed on the display does not equal the actual known volume that was sprayed out. The below formula can be used to “fine tune” the flowmeter PPU.

$$\text{New PPU} = \frac{\text{Original PPU} \times \text{Displayed Volume}}{\text{Sprayed Volume}}$$

For example, the spray tank is filled with 2400 litre of spray liquid. When sprayed out, the display showed a total of 2300 litre. (Original PPU = 120.0)

$$\text{New PPU} = \frac{120.0 \text{ (Original PPU)} \times 2300 \text{ (Displayed Volume)}}{2400 \text{ (Sprayed Volume)}} = 115.0$$

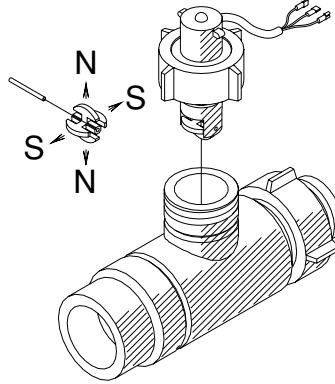
Note the relation is inverse:

- To raise the displayed volume, the PPU is lowered.
- To lower the displayed volume, the PPU is raised.

Testing flow transducer (ref. no. 728816)

Wire connections: BROWN wire to positive of 12 volt battery.
BLACK wire to negative.
BLUE wire to multimeter positive.

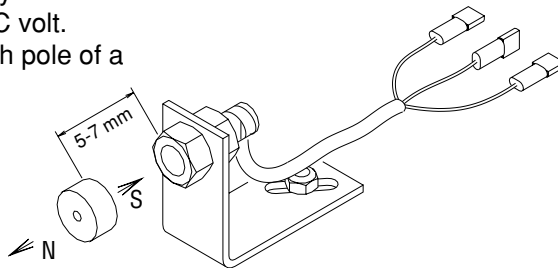
1. Check the rotor turns freely.
2. Each vane in the rotor has a magnet in it with the pole facing out. Check that the 4 magnets are present.
3. Check every second magnet has the same pole orientation so the rotor magnets are N - S - N - S.
4. Connect negative from multimeter to negative of battery.
5. Set multimeter to DC volt.
6. By turning the mill wheel slowly, this will register approx. 8.0 +/- 1 volt with the diode on and 0.3 +/- 0.1 volt with the diode off with every second magnet.

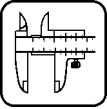


Testing speed transducer (ref. no. 729058)

Wire connections: BROWN wire to positive of 12 volt battery.
BLACK wire to negative.
BLUE wire to multimeter.

1. Connect negative from multimeter to negative of battery.
2. Set multimeter to DC volt.
3. By bringing the south pole of a magnet (distance 5 mm +/- 2 mm) by the transducer, this will register 0.3 +/- 0.1 volt.
4. By removing the magnet, this will register 7.0 +/- 1.0 volt.





Technical specifications

Supply voltage	12 Volt
Minimum supply	11 Volt
Maximum supply	14 Volt
Maximum peak	16 Volt
Fuse	4.0 Amp Ø 6, 5 x 32 F. Quick acting
Ambient temperature	- 20° C to + 50°C
Update from all transducers	4 times per second
Update of non-volatile memory	every 0.5 ha

Chart showing when treated area is registered

	SPEED	FLOW	AREA
SPEED		UPDATE	UPDATE
FLOW	UPDATE		
AREA	UPDATE		

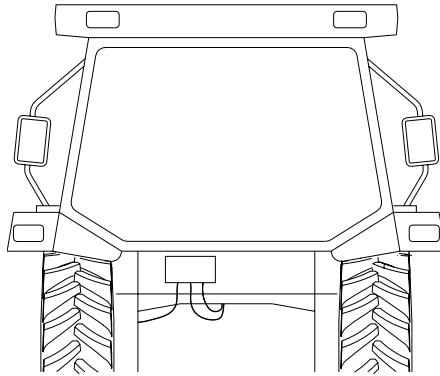
Assembly

HP 3010 tractor junction box

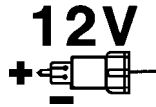
The box is fitted at a convenient place at the rear of the tractor. The cables should face downwards.

The coaxial cable is led into the tractor cabin and connected to the display.
The power supply is 12 Volt DC.

Connect transducer cables.
For flow transducer, cut cable approx. 30 cm from connectors and fit plug and socket.



Brown wire is positive “⊕”.
Blue wire is negative “⊖”.

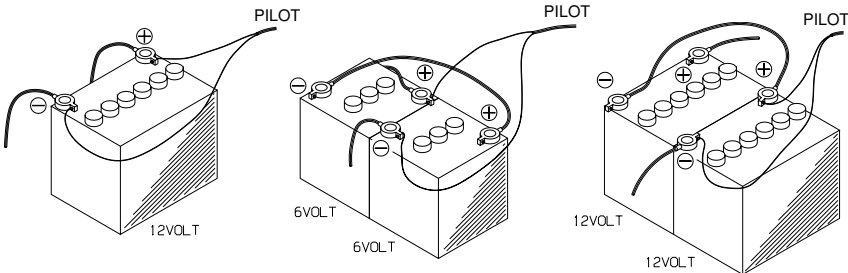


Fuse 4.0 Amp Ø 6, 5 x 32 F. Quick acting (HARDI ref. no. 261617)

It is recommended that the power supply should come directly from the battery.

If desired, the power supply may come via the ignition key of the vehicle.

An on/off switch can be fitted over the jumper connection if this is desired.

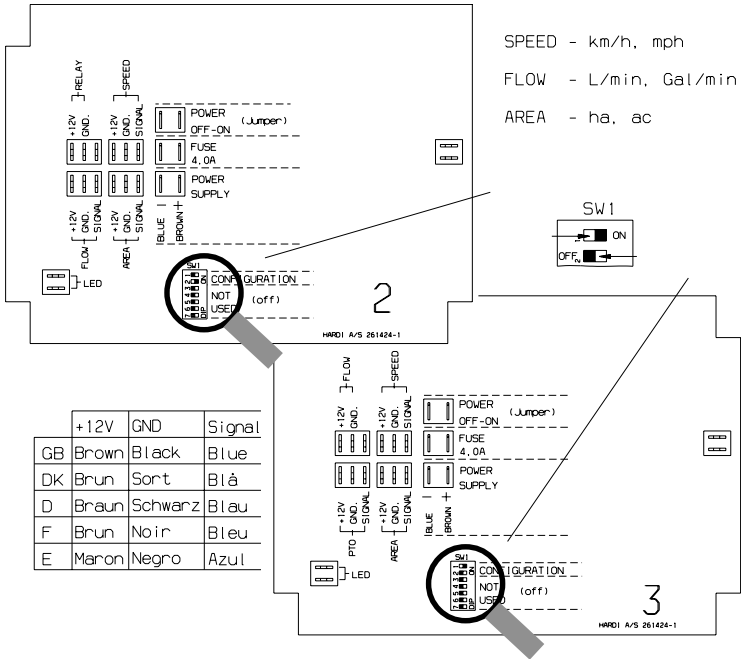


NOTE: Do not connect to the alternator or suspect installation.





Check the configuration of HP 3010. See below for slide switch position and transducer wire connections. (Info. sheet also attached to HP 3010)



HP 3570 display

The display can be fixed to a flat surface with the supplied “Velcro” tape. Power must be disconnected before attaching the BNC connector plug to the display connector jack.

The connector has a bayonet fitting. To attach, locate guide groove, push and turn.

Transducer wire colour code

Wire colour	Connection for transducer
Brown	12 Volt supply
Black	GND
Blue	Signal



Speed transducer

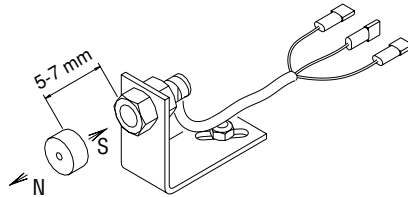
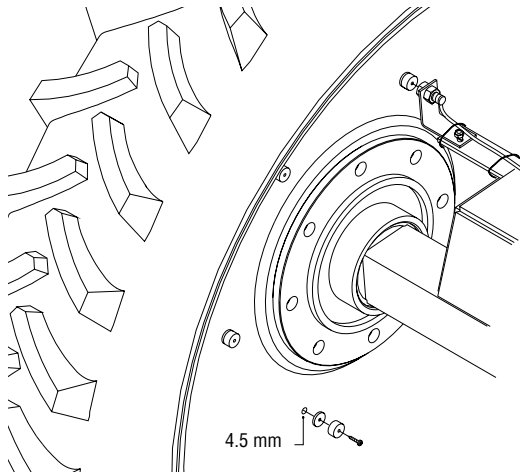
Speed transducer is fitted as shown. Hole size is 4.5 mm.

Magnets must be placed an equal distance (and at least 150 mm) from one another.

Recommended number of magnets fitted are as follows:

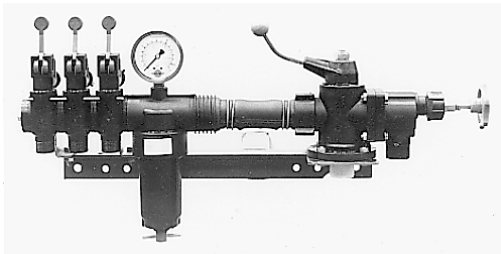
- Tractor front wheel (rim size up to 20") ----- 4
- Tractor rear wheel (rim size over 20") ----- 6
- Transmission driveshaft ----- 1

The south side of the magnet must face the transducer.
Distance between them must be 5 to 7 mm.

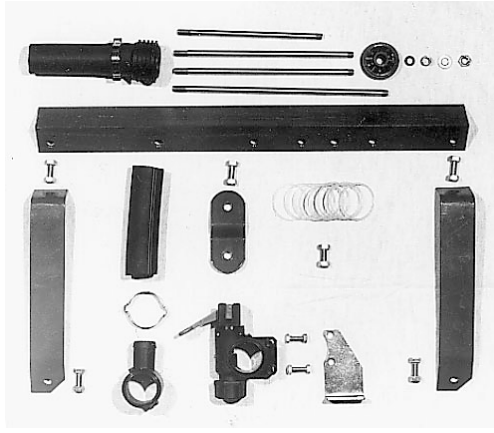


Flow transducer for BK operating unit

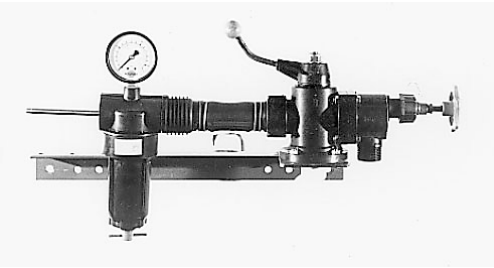
For BK operating unit, a mounting set is available (HARDI ref. no. 833696).



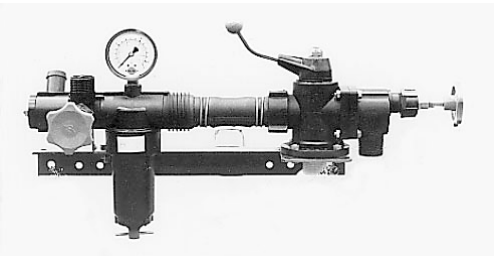
1. Disconnect hoses.



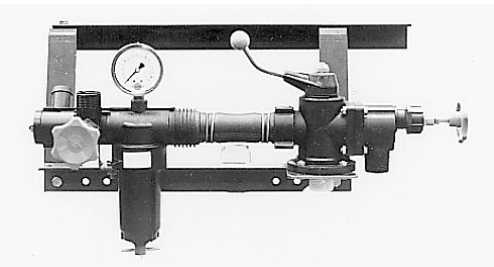
2. The set converts the unit to 2 levels. Use new seals supplied.



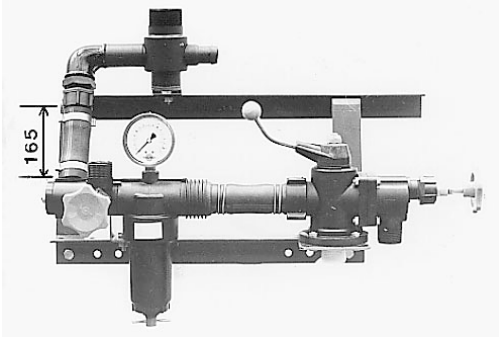
3. Remove the distribution valves and replace the threaded rod with the shorter one (213 mm).



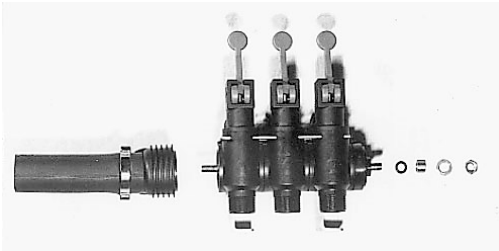
4. Fit HARDI-MATIC with metal support bracket and filter. Bolt bracket to rack arm. Fit elbow and end cover with O-ring for the rod, washer and nut.



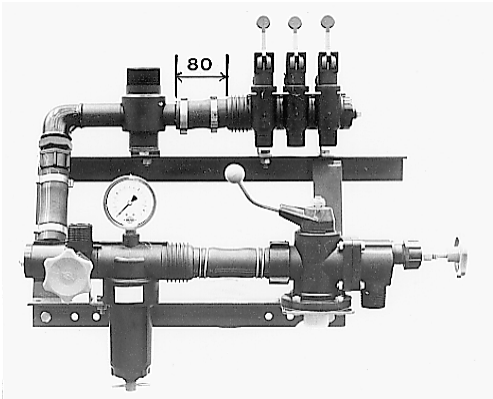
5. Bolt the upper rack arm.



6. Shorten the hose piece to 165 mm and connect as shown.



7. Assemble the distribution valves. The end cover must have the ribs facing outwards. Assembly order is O-ring, bushing, disc and nut. Remember the new seals.

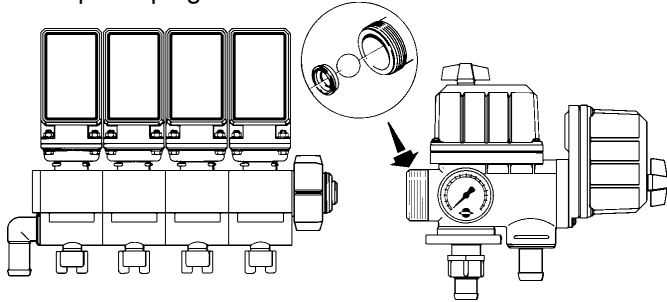


8. Shorten hose to 80 mm and connect. Insert the flow transducer into the housing.



Flow transducer for EC operating unit

1. The distribution valve unit is detached from the main ON/OFF valve unit. Note the orientation of the ball seat and remove it from the distribution valve unit.
2. Mount the flow transducer housing just before the distribution valves.
3. Attach distribution valves with flow housing with the ball seat on the end to main ON/OFF valve unit.
4. Flow transducer is fitted to the housing and connected to HP 3010 via the a 3 poled plug.

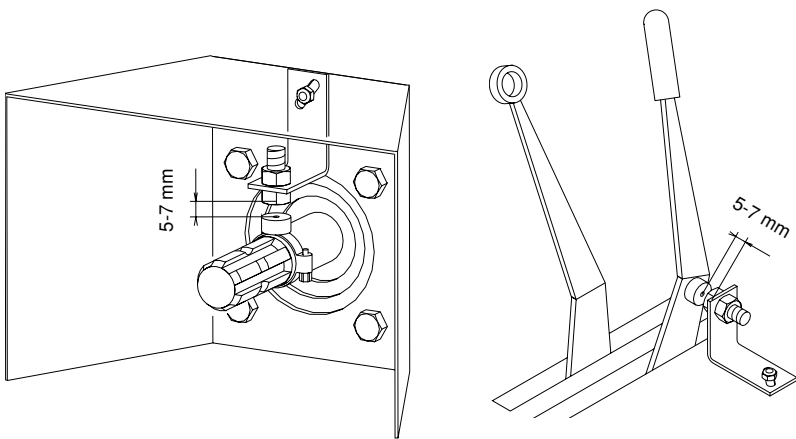


P.T.O. transducer and areameter

The south side of the magnet must face the transducer.

Distance between them must be 5 to 7 mm.

An adjustable hose clamp drilled with a 4.5 mm hole can be used to attach the magnet to the P.T.O. shaft.



Packaging information

Materials used for packaging are environmentally compatible. They can be safely deposited or they can be burnt in an incinerator.



Recycling

Cardboard: Can recycle up to 99% and therefore should be put into the waste collection system.

Polyethylene: Can be recycled.

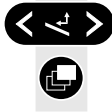
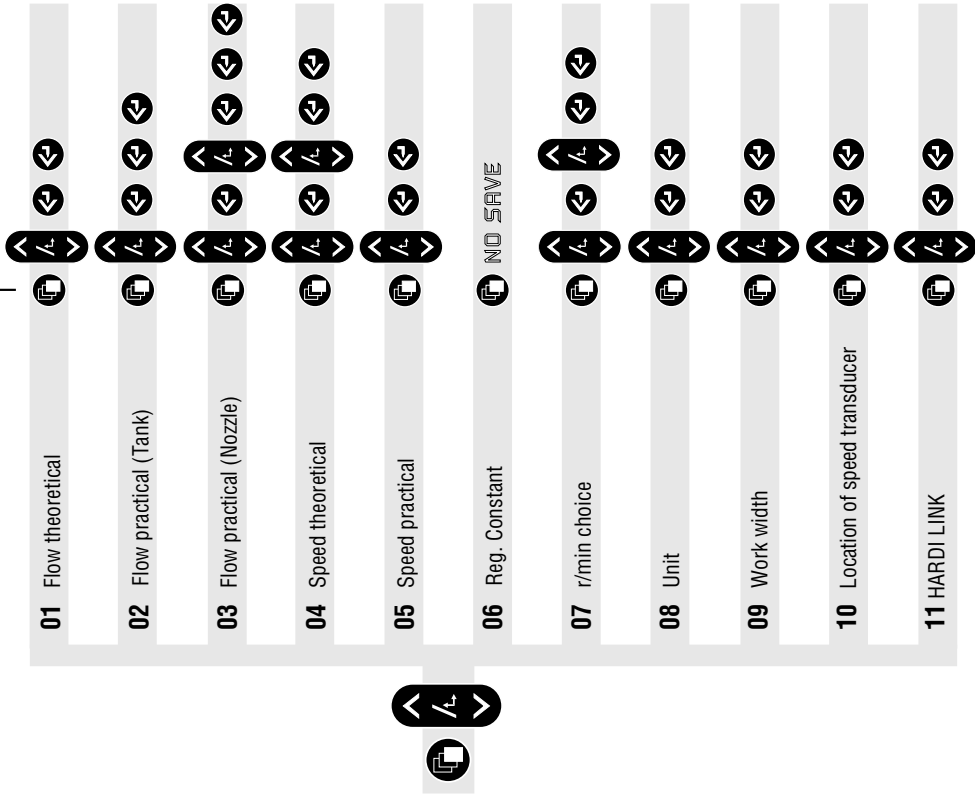
When the HARDI PILOT has completed its working life, it must be thoroughly cleaned. The synthetic fittings can be incinerated. The printed circuit boards and metallic parts can be scrapped.

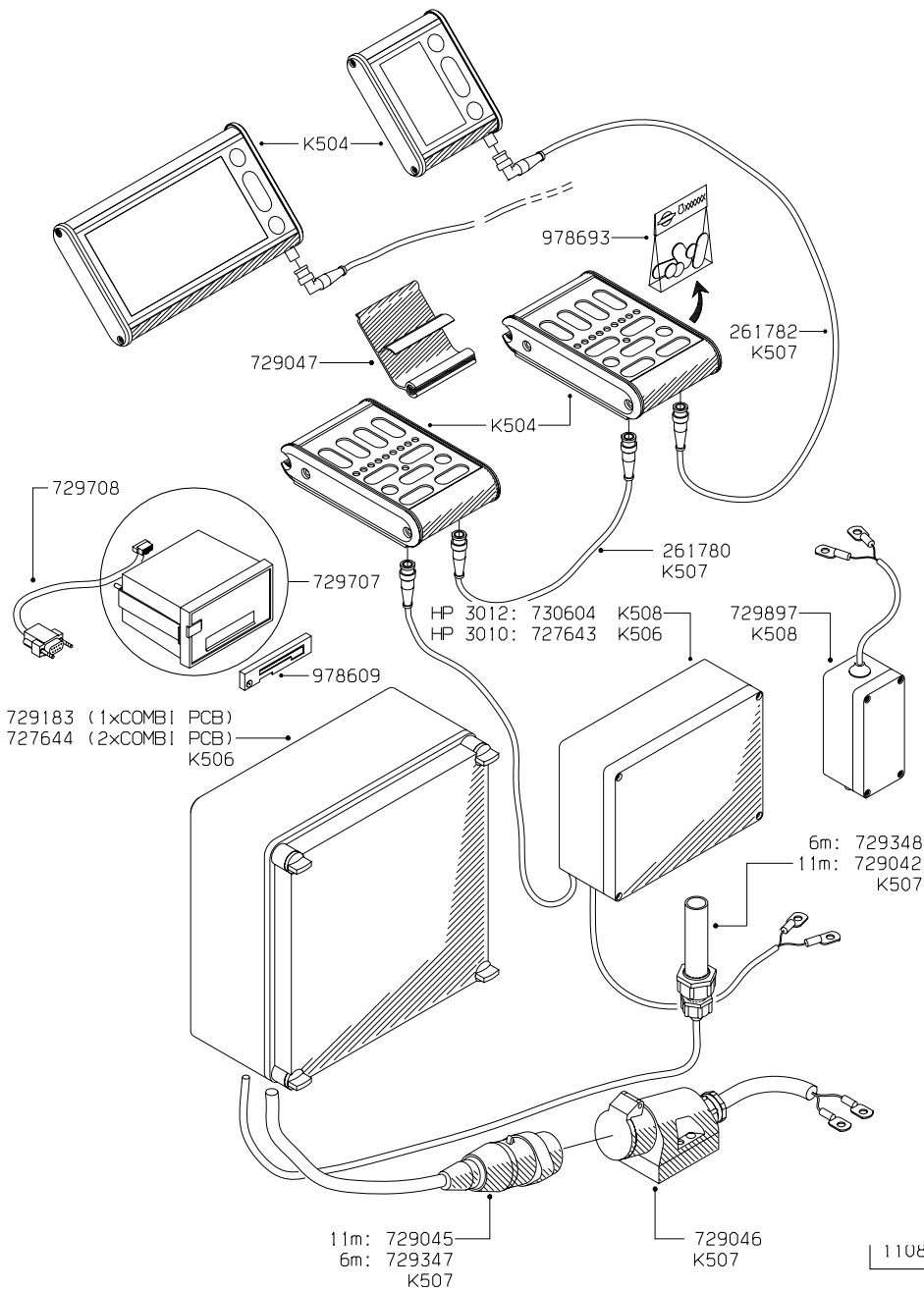


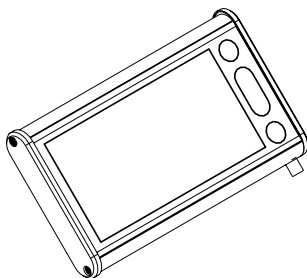
Chart for recording values

Menu	Function	1 - Values	2 - Values	3 - Values
	Nozzles colorus			
01	Flow PPU			
04	Speed			
	Number of magnets			
	Wheel radius (cm / inch)			

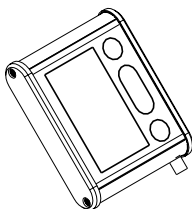
Press more than 3 seconds



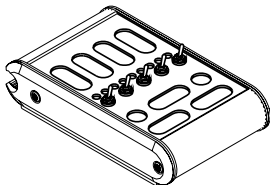




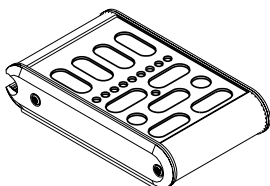
	HP 3880	
	WITHOUT GPS	GPS AGRO/FIELDSTAR
NY/NEW/NOUVEAU NEU/NUEVO	727642	731803
OMBYT./EXCHANGE ECHANGE STANDARD UMTAUSCH JUEGO DE CAMBIO	731895	731929
DEFEKT/DEFECTIV DEFECTUEUX DEFEKT DEFECTUOSO	731896	731930



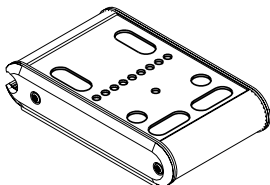
	HP 3570
OMBYT./EXCHANGE ECHANGE STANDARD UMTAUSCH JUEGO DE CAMBIO	731897
DEFEKT/DEFECTIV DEFECTUEUX DEFEKT DEFECTUOSO	731898



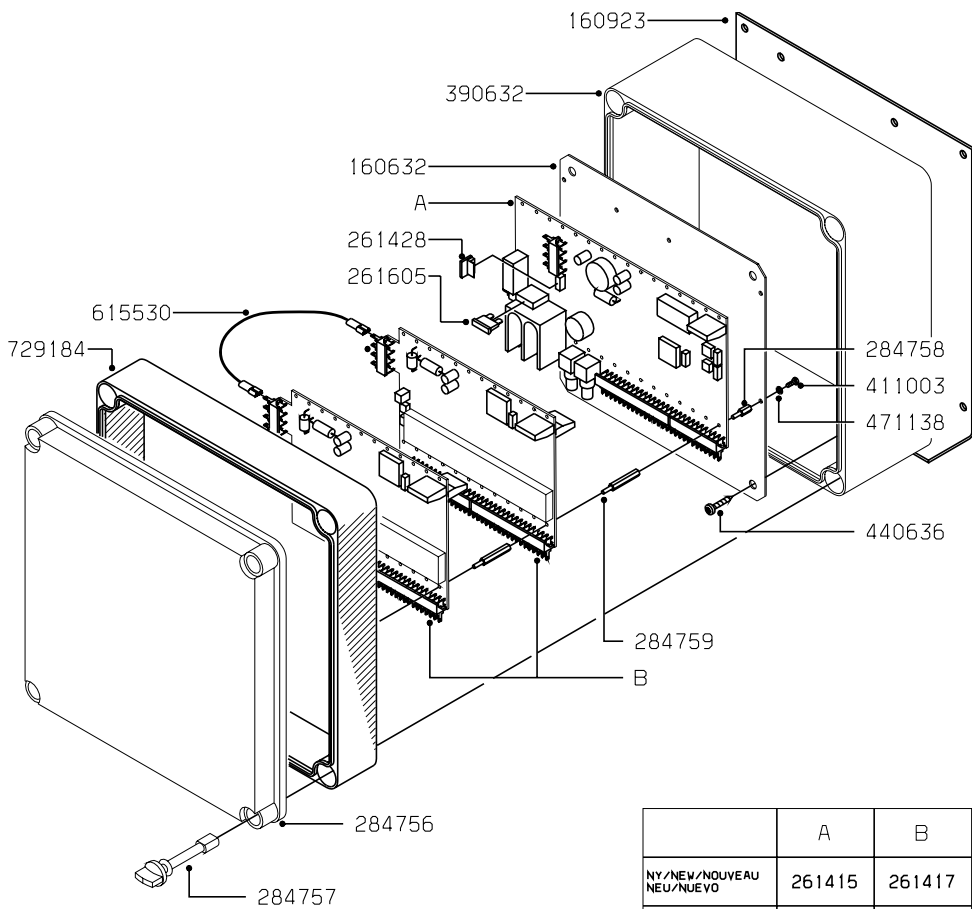
	HP 3503	HP 3504	HP 3505	HP 3507
NY/NEW/NOUVEAU NEU/NUEVO	731259	731260	731261	731263
OMBYT./EXCHANGE ECHANGE STANDARD UMTAUSCH JUEGO DE CAMBIO	731905	731907	731909	731913
DEFEKT/DEFECTIV DEFECTUEUX DEFEKT DEFECTUOSO	731906	731908	731910	731914



	HP 3500	HP 3600
NY/NEW/NOUVEAU NEU/NUEVO	727639	727640
OMBYT./EXCHANGE ECHANGE STANDARD UMTAUSCH JUEGO DE CAMBIO	731899	731901
DEFEKT/DEFECTIV DEFECTUEUX DEFEKT DEFECTUOSO	731900	731902



	HP 3550
NY/NEW/NOUVEAU NEU/NUEVO	731601
OMBYT./EXCHANGE ECHANGE STANDARD UMTAUSCH JUEGO DE CAMBIO	731919
DEFEKT/DEFECTIV DEFECTUEUX DEFEKT DEFECTUOSO	731920



	A	B
NY/NEW/NOUVEAU NEU/NUEVO	261415	261417
OMBYT./EXCHANGE ECHANGE STANDARD UMTAUSCH JUEGO DE CAMBIO	731921	731923
DEFEKT/DEFECTIV DEFECTUEUX DEFEKT DEFECTUOSO	731922	731924

