

Please note

HARDI TRONIC series No. _____

Power Supply Box series No. _____

Table of Contents

Description	4
Operating Diagram	5
Before Use	7
Keyboard Explanation	9
Operation and Function	11
Operating of the Boom	18
Calibration	20
Area Switch	25
Maintenance and Storage	26
Fault Finding	27
Spare Part Drawings	30
Assembly	31

TRONIC 2000
Instruction book

674930-GB-87/10



Description

The HARDI TRONIC 2000 is an electronic spray monitoring system, which measures and displays the travel speed, measures, displays and controls the applied spray liquid. It adjusts the pressure in the spray system and informs on details of total spray liquid volume, total area treated, etc.

The electronic spray equipment consists of a processor control unit with keyboard and two LCD displays, where the actual values can be read during spraying.

The processor control unit, which must be programmed before starting, can be set for automatic control of the pressure regulation valve during spraying. The actual application is electronically controlled and adjusted to the desired application rate, which is calibrated into the TRONIC. All functions on the operating unit and the hydraulic functions of the spray boom are controlled from the control panel.

At the back of the processor control unit are found 5 plugs to which sensors and power supply box are connected. See label and colour code. Speed sensor, flowmeter, area switch and pressure transducer as well as connection to power supply box. Model description and series number are stated on the label.

The plugs from the electrically operated EC operating unit and the electrically operated boom fold hydraulic valves are connected to the power supply box, which is in turn connected to the tractor battery which should be 12 Volt.

For measurement of the forward speed and area treated a speed sensor is placed on the tractor front wheel. The speed sensor is activated by a number of magnets sending impulses to the processor unit.

A flowmeter built into the operating unit is used to measure the amount of liquid applied. The flowmeter sends impulses to the processor unit which again calculates the liquid volume and flow per time unit.



A pressure transducer is used for measurement of the spray pressure. It gives signals which are converted in the processor unit to atmospheric pressure.

For measurement of the area treated an area switch is used, which is identical with the speed sensor. This sensor is used instead of the flowmeter - when working with other implements such as fertilizer spreaders, seeding machines, harrows, etc. The flowmeter plug is removed and the area switch plug fitted.

Operating Diagram

- A. Electronic display and keyboard
- B. Power supply from tractor battery
- C. Flowmeter for applied liquid
- D. Speed sensor with magnets for speed measurement
- E. Area switch switch when using other types of implements
- F. Pressure transducer
- G. Power supply box for boom sections and operating unit
- H. EC operating unit
- I. Electric valves for hydraulic boom functions

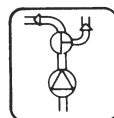

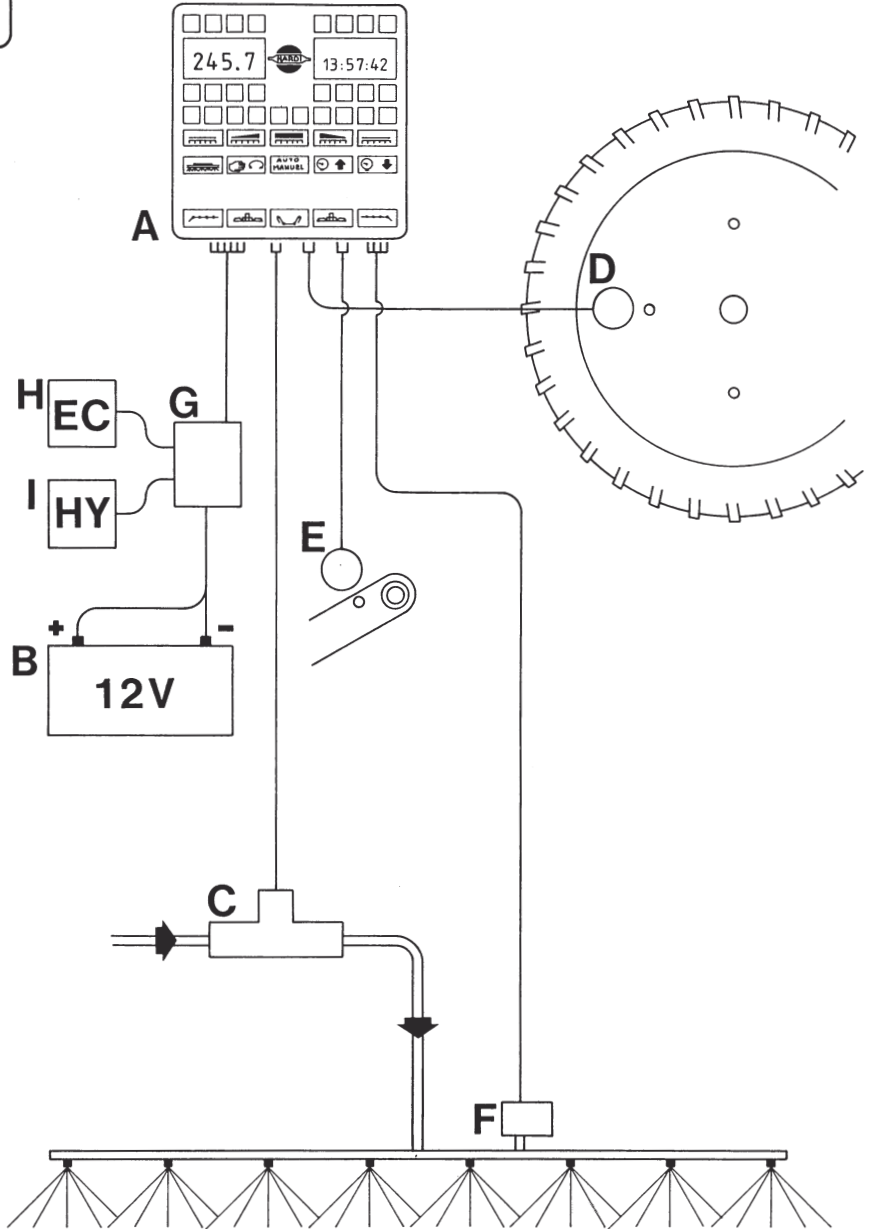

Before use

Power Supply



A battery cover on the back of the HARDI TRONIC is opened by loosening the screw. The HARDI TRONIC supplied with electricity from 4 1.5 V batteries, type LR 14. The light in the display comes from the tractor 12 V power supply.

The life of the batteries is 400 - 1200 working hours. In cold weather the TRONIC should be kept in a warm place, otherwise battery life will be reduced. The TRONIC should be turned off, when not in use.

NB: Change of batteries must be done within 15 min. Otherwise all the constants will delete and have to be coded again. The display must be turned off before changing batteries.

The display BAT shows - on the left display under |○●| the on/off pad, when the batteries are losing their effect and must be replaced within 24 hours.

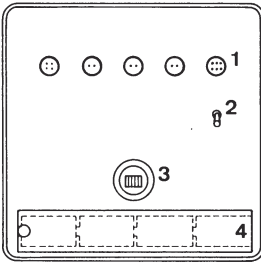

1. Connection of sensors and power supply box.
2. Rocker switch for ON/OFF for 12 V connection.
3. Switch
4. Fitting of batteries

Connection of Wires from Sensors

5 plugs from the various sensors and the power supply box fit sockets on the back of processor control unit. See label and colour coding.



HARDI-TRONIC		NR		HARTVIG JENSEN & CO. A/S 6 FARVERLAND • DK 2600 GLOSTRUP • DENMARK	
Pressure	Areameter switch	Speedometer	Flowmeter	12V/Driverbox	



Power Supply Box

The power supply box is connected to the electric system of 12 V of the tractor. The brown wire to be connected to the +pole and the blue one to the -pole.

Connect plugs from EC-operating unit and EC-hydraulic valves.

Turn on the power supply box by activating the rocker switch. The red lamp flashes when the HARDI TRONIC is connected to the 12 V system and gives a constant light when the HARDI TRONIC is disconnected to the 12 V.



Slide Switches

Behind the protection cover also at the back of the TRONIC are found 5 slide switches. Before coding the various values in the calculation unit, these switches must be correctly set.

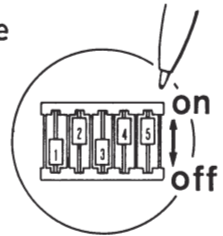

Switch No.

1. For reset of the processor control unit cancel all previous constants. The switch must always be at OFF position. Only if you want to cancel all previous constants, the switch must be set at ON and then back to OFF.
2. Pressure equalisation system. When the operating unit on the sprayer is equipped with pressure equalisation valves, the switch is set at OFF. In case of no pressure equalisation system the switch must be set at ON.
3. Choice of unit system.
Metric
Bar, hectare, litre, kilometre: Set switch at ON.
US/Imp.
Psi, acre, gallon, miles: Set switch at OFF.

4. Switch for locking of constants.

Before calibration the switch is set at OFF.

When the wanted constants are fed into the processor control unit and are to be retained the switch is set at ON.



5. Built-in signal damping system. Switch must always be set OFF.

THE SWITCHES MUST ALWAYS BE OPERATED WITH CAUTION. FOR INSTANCE, USE A BALLPOINT PEN OR A SMALL SCREW DRIVER TO OPERATE THE SWITCHES. NEVER USE A PENCIL, THE GRAPHITE MAY CAUSE A SHORT IN THE SYSTEM.

NB: Do not forget to fit the protection cover after resetting of switches.

Keyboard Explanation



 Main switch, ON/OFF for processor control unit.

 Display of actual application rate. Preselected application rate.

 Incorrect application. If the actual application is less than the one preset, a negative sign is shown on the display at the extreme left. If the actual application is higher than the one preset, there will be no corresponding positive sign.

 On/off for application alarm (acoustic alarm).

 Display of total liquid volume applied.

 Display of total distance.

 Display of total area treated.



Clock function (hours/min./sec.).



Display/calibration of liquid volume rate/min.



Display of speed per hour.



Working width of the implement.



Display of spraying pressure.



Neutral position of functions (clear).



Memory key. Calibration constants (memory).



Coding key (enter).



Dot. For decimals.



Numeric key from 0 to 9.



Boom sections



On/off function of main valve.



If the valves on the operating unit have to be operated by hand.



The pressure valve adjusts automatically or manually.



Increase liquid pressure



Decrease liquid pressure



Keyboard for operating the hydraulic functions on the boom (if mounted).

Operation and Function

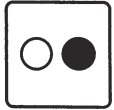



Main Switch ON/OFF for Processor Control Unit

When turning on the HARDI TRONIC, the press must last abt. 2 sec., then the TRONIC gives a short bleeping sound.

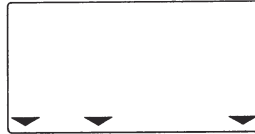
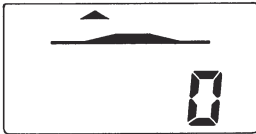
For a few seconds the display shows which sensors are connected.





- On the left display the boom becomes active, if the area switch is CORRECTLY installed.
- On the right display above the key  is shown an arrow indicating that the flowmeter is CORRECTLY fitted.
- Also an arrow above  indicates that the speed sensor is CORRECTLY fitted.
- An arrow above  indicates that the pressure transducer is CORRECTLY installed.

If the ON/OFF key is kept activated, the display will repeat the starting control procedure until it is no longer activated.

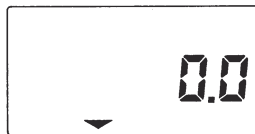
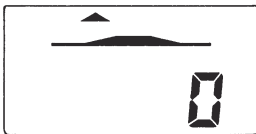
After the starting procedure, the left display shows the application rate and the right display the travel speed.

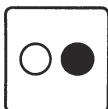



All ON/OFF functions are in OFF-position, however, except the alarm  ON/OFF function, which remembers even when the monitor is switched off. If correctly operated, the TRONIC gives a short bleeping sound, if incorrectly operated it gives a much longer bleep sound.

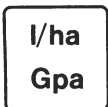

Spray Volume Rate

The key litre/ha has two functions. It shows the actual and the preset application rate, which is put into the memory.

Preset of application rate. In order that the monitor can work correctly, the required application rate l/ha must be put in.

Input of the application rate, for instance 200 l/ha.



To check function



During spray work the actual application rate can be seen by pressing



Spray Volume Deviations

Deviations in application rate in percentage. If the actual application rate is smaller than the rate required, a minus is shown on the display at the extreme left.

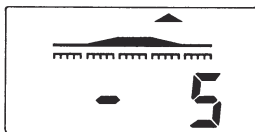

If the actual application rate is higher, no plus appears in front of the figure displayed. An acoustic alarm, which goes on or off as per wish, is functioning as an application rate guard.

The operator inputs the limit of the alarm. A percentage value from +/- 1 to +/- 9. If the alarm limit is set at +/- 5% of the application rate, the alarm goes on if the application rate deviates more than +/- 5%.



Input of the alarm limit in percentage. For instance 5% (deviation of +/- 5%).



To check function

Acoustic Alarm



During spraying the monitor will function as application rate guard. The rate will continuously be measured and compared with the preset rate.

The alarm is set/turned off by pressing .

Memories with Two Functions



The purpose of having double function keys is currently to tell how many

- litres/gallons have been applied
- hectares/acres have been treated
- metres/miles have been driven

The purpose of double functions is for instance: Register 1 is set at neutral at the beginning of a new task, register 2 can sum up the values of a whole season or similar.

When pressing the totally applied liquid rate is shown. contains two memories



First press 1st memory

Second press 2nd memory



When pressing  the total distance driven is shown.
contains two memories:

First press 1st memory ▼

Second press 2nd memory ▼

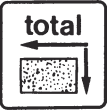



When pressing  the total area treated is shown.
contains two memories:

First press 1st memory ▼

Second press 2nd memory ▼



Values summed up can be cancelled individually. This is done by

1st memory:  **C** 

2nd memory:   **C** **E** 





Clock Function

When pressing  the time will appear in the right-hand display.

Input of the time, e.g. 10.45.30

 **C** **1** **0** **4** **5** **3** **0** **E**  



Stop watch function. To clear the time.  **C** **E**  

The watch is started by pressing once and stopped by pressing twice.

When pressing once on the key the clock will show.
When pressing twice the clock stops.



The clock goes on even when the display is switched off.

Liquide Volume Rate per Minute

When pressing on  the actual liquid volume rate per min. during spraying will show. See under calibration of .



Forward Speed per Hour

When pressing on  when driving the actual forward speed per hour will show. See under calibration of .



Working Width

Display of the actual working width of the sprayer or the implement. Function with two decimals is shown on the display when pressing .

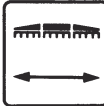

The working width of the sprayer is divided into sections depending on the number of distribution valves of the operating unit.

For example, 16 m spray boom with 4 distribution valves each of 4.00 m.



or 12 m spray boom with 3 distribution valves.



Coding of working width for e.g. 16 m boom with 4 distribution valves each of 4.00 m.



To check function 



This is done for each boom section.
Each section can be coded to 2 decimals.

On the left-hand display the boom sections are shown whether spraying or not. If a section is switched off, the new width is shown on the right-hand display by pressing .



It is important that the exact measurement for the boom sections are correctly coded enabling the processor control units to calculate the correct application rate, area, litre and actual working width.

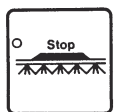

Main Valve ON/OFF



Operating of the main on/off valve on the operating unit. Opening and closing of the liquid to the boom. On the left-hand display the sign 'boom' flashes when the main valve is closed and is constant when the main valve is open.



Liquid flow to boom closed 



Liquid flow to boom open 



Manual Operating of Operating Unit



The function switches off totally the power supply to the operating unit so the unit can be hand-operated.



Important: The EC operating unit must not be operated by means of the hand levers when the power is connected to the operating unit.

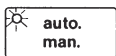

Automatically or Manually Operated System



When the function is set on AUTO an A is shown on the left-hand display. When AUTO is connected, the pressure regulating valve on the operating unit is automatically adjusted. Electronic calculations preset according to the required application rate, regulate the liquid pressure of the spray system.

AUTO is automatically switched off, when:

 All boom sections are disconnected

  Regulation of pressure up or down is activated

 The STOP function is activated

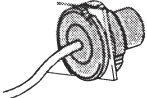
 No impulses from the speed sensor

The pressure regulating valve is NOT regulated automatically when the function is set on MANUAL.

The AUTO function is coded with an amplification constant from 0 to 9 (only one figure). The AUTO function is disconnected when the constant is 0. When the constant is 1, the pressure regulation is less sensitive. When being 9 the pressure regulation is very sensitive. In general, the amplification constant should be between 3 and 5. Display of amplification constant.

 Figures are shown on the left-hand display

For example, coding of amplification constant 4



To check function 



Manual Pressure Regulation

Two functions for raising or lowering of the liquid pressure on the EC pressure regulating valve.



When operating one of the functions the key is kept activated by finger touch and the TRONIC will give a bleeping sound.



Reading of Spraying Pressure

When pressing  the actual liquid pressure of the spray system can be seen. On the pressure sensor fitted on the boom the actual pressure is updated once a second and shows the pressure in bar on the right-hand display. The pressure sensor needs a constant coded in the memory, which should be around 3050, see calibration.

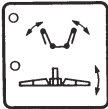

Operating of the Boom

(If mounted with electrically remotely operated hydraulic system).

BEFORE UNFOLDING THE BOOM IT IS IMPORTANT TO LIFT IT OFF THE BRACKETS WHICH HOLD IT IN THE TRANSPORT POSITION, AND CONNECT THE TRACTOR TO PREVENT OVER-BALANCING THE SPRAYER.

THE FOLDING AND UNFOLDING OF THE BOOM MUST ONLY TAKE PLACE WHEN THE TRACTOR IS NOT MOVING.

WARNING



TESTING OF THE HYDRAULIC SYSTEM SHOULD BE DONE VERY CAUTIOUSLY; THERE MAY BE A LITTLE AIR IN THE SYSTEM AND THIS MAY CAUSE VIOLENT MOVEMENTS OF THE BOOM. THEREFORE TAKE CARE THAT NO PERSONS OR OBJECTS ARE HURT OR DAMAGED IN THE PROCESS OF TESTING.

Operating Instructions

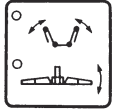

THE BOOM IS OPERATED BY USING THE HYDRAULIC CONTROLS OF THE TRACTOR.

The boom is lowered/lifted by using the single acting outlet.

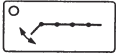

Folding/unfolding of left outer section

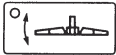

Left intermediate/outer section is lowered/lifted



Folding/unfolding of intermediate section

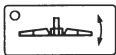

Right intermediate/outer section is lowered/lifted

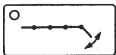

Folding/unfolding of right outer section

By keying the boom folding functions on the control module, the movement of the chosen boom section(s) is controlled by using the hydraulic lever of the double acting spool valve.



A light indicates the functions that are active.

To lift/lower the left and right side of the boom simultaneously, the keys must be activated at the same time.



The outer sections can also be folded/unfolded simultaneously by activated the keys at the same time.



In case of power failure to the hydraulic functions it is possible as an emergency to activate all functions by pressing each electric valve and activate the hydraulic handle.

All hydraulic functions will be switched off after an interruption of  ON/FFF.

Calibration



Calibration of the Flowmeter

The flowmeter is fitted in the operating unit system of the sprayer. It measures the liquid volume being sprayed out through the nozzles. In the T-piece of the flowmeter the sensor unit itself is fixed by means of a union nut.

The sensor unit is provided with a mill wheel with 4 wings. Four magnet are cast into each wing. The mill wheel is rotated by the passing liquid.

Thereby the sensor gives electrical signals to the processor unit.



Calibration of Flowmeter by Trial

This is done by measuring the spray volume rate from one or more nozzles at a given pressure.



l/min
Gpm

Example:

A 16 m spray boom with 32 nozzles (nozzle distance 50 cm). The volume of each nozzle is 1.59 l/min at a pressure of 3 bar. The total spray volume rate to the boom per minute will then be 1.59×32 nozzles = 50.88 l.

The nozzle volume l/min. can be looked up in a table, but a measurement made by means of a measuring jug from one or more nozzles will be a better method to find the volume per nozzle and thereby the spray volume rate l/min. of the boom.

The calibration is made by pumping clean water to the spray boom at a preset adjustment. Pressure and nozzle are correct according to volume in litre.

Calibration by tests e.g. 50.88 l/min. total spray volume rate to the spray boom.



The calibration is started. A constant flow must pass through the flow sensor. The left-hand display shows the frequency of impulses from the flow sensor. The impulses must be constant before coding the application rate in litre.

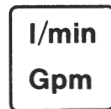

Code 50.88 l/min.



The calculation unit calculates the calibration constant. The constant is shown on the right-hand display.

Reading, control of the calibration constant  .

Calibration of Flowmeter by Keying

In case of input of a constant known in advance of e.g. 606.

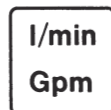
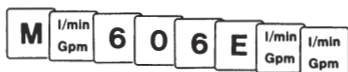
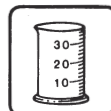

To check function 

Calibration of Speed Sensor

The speed sensor fitted close to a wheel disc is passed by magnets fixed to the wheel disc. At each rotation of the wheel the speed sensor gives electrical signals corresponding to the number of magnets. Two different calibration methods can be used.

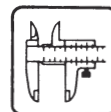

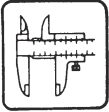

Calibration of Speed Sensor by Calculation

km/h
mph

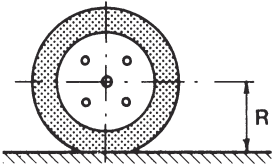

R = Rolling radius is measured in metre and inserted in a formula.

$$\frac{N \times 1000}{2 \times 3,14 \times R} = \text{Calibration constant}$$

N = The number of magnets fitted on the rim.

Ex:

$$\begin{array}{l} N = 4 \text{ magnets} \\ R = 0.485 \text{ m} \end{array} \quad \frac{4 \times 1000}{2 \times 3.14 \times 0.485} = \begin{array}{l} 1313 \\ \text{====} \end{array}$$

Input of calibration constant.



To check function



IMPORTANT: Check frequently the tyre pressure. In case of much wear, calibration should be done frequently. If 4-wheel drive is connected during measurement of the wheel circumference, the 4-wheel drive must also be connected during work.

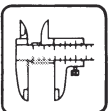

Calibration of Speed Sensor by Trial

km/h
mph

This calibration takes place by driving a pre-measured distance. The distance may be between 2 trees, milestones on the road or similar.

NB: The distance should be at least 75 metres.

EXAMPLE

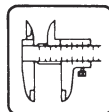
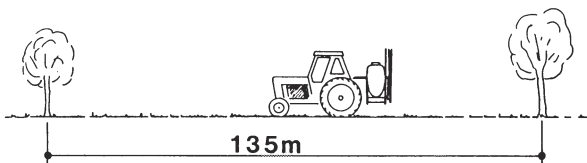



A known distance is e.g. 135 m (without decimals). At starting point the following is put in.



The distance is driven. Then the 135 m is put in.



The processor unit calculates the calibration constant. Can be seen on the right-hand display  .

Reading/control of the constant 

Calibration of Pressure Transducer



The pressure transducer which is fitted in the liquid system at the boom, updates the actual pressure once a second.

Calibration of Pressure Transducer by Trial



The calibration constant of the pressure transducer is calculated from two calibration points. Two pre-decided pressure ranges, for example 2 bar and 8 bar.

The calibration is started with clean water in the sprayer and the pressure set at 2 bar on the pressure gauge of the operating unit. Then the following must be done.





On the left display a figure of three digits is shown. When the figure appears without too much variation, the figure 2 for 2 bar is coded.

2 E

Instantly, the pressure is readjusted up to 8 bar on the operating unit. A new figure of 3 digits is shown on the left-hand display. The figure 8 is coded, when the figure of three digits appears calmly.

8 E

On the right display you can now see the calibration constant, which should be around 3050.

When pressing  the actual pressure is shown.

To check function. 



Calibration of Pressure Transducer by Keying

Keying of a pre-known constant, e.g. 3050.

M  3 0 5 0 E  

To check function 



WHEN CALIBRATION AND INPUT OF THE VALUES HAVE BEEN MADE, THE SWITCH NO. 4 IS SET AT ON-POSITION. THE CONSTANTS ARE LOCKED AND CANNOT BE CANCELLED OR CHANGED BEFORE THE SWITCH AGAIN IS SET IN OFF-POSITION.

Table for Recording of Constants



Tyre size	Constant km/h	Spray chemical	Constant l/min	Nozzle no.



Area Switch



The area switch is used in connection with other types of implements and can be fitted at various places according to the implement.

The area switch is necessary for controlling the start and finish function of the area measuring.

When using the area switch the below routine is followed.

- Switch off the TRONIC 
- Dismount plug from flowmeter
- Fit plug from area switch
- Switch on the TRONIC 
- Key working width of implement 

When this measuring must stop, the magnet and sensor must be precisely opposite each other. The distance between sensor and magnet should be 5 to 7 mm.

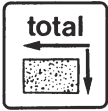

When area counting is started, the magnet must be moved at least 20 mm away from the middle of the sensor.

The area switch can be placed at

- the lift function of the tractor
- coupling lever of the PTO outlet
- opening/closing function of an implement
- lifting/lowering function of a trailed implement

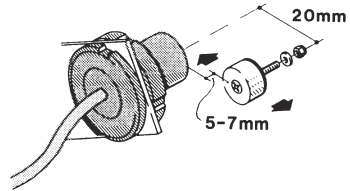

Maintenance and Storage

The HARDI TRONIC 2000 is a precision instrument that can work without problems for many years, if just the following rules concerning maintenance and storage are kept:



1. Place all cables in order to avoid any damage. Pay special attention to wear and tear from the tractor and to any direct pull on the cable assemblies, etc.
2. When no longer in use, the instrument should be kept indoors, protected against the sun, humidity, dust, frost and heat. In cold weather the batteries lose their efficiency.
3. Avoid water or rain direct on the instrument.
4. When the spraying season is over the measuring unit of the flowmeter should be dismantled from the T-piece.

Clean the mill wheel thoroughly and test to see if it can rotate without any resistance.

5. The wheel magnets can attract magnetic materials, this must be kept clean. Earth, plants and similar must be removed from the magnets and the speed sensor.



6. During winter, where the TRONIC is not used, it is advisable to remove the batteries in order to avoid possible leakage. Or fit new batteries to avoid loss of constants.



7. Check frequently the distance between the wheel magnets and the sensor.

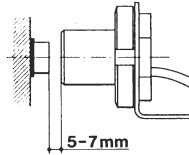

8. The pressure transducer fitted on the spray boom must be checked frequently and cleaned with caution to remove chemical deposits. Thereby the most exact measurement is obtained.

Fault finding



If the HARDI TRONIC does not operate as expected, it may be due to errors in the system or lack of maintenance.

- If a problem appears check first all the constants:

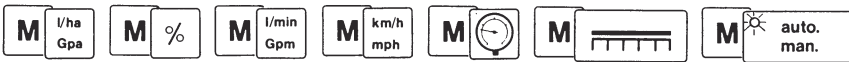

- Check on the back of the HARDI TRONIC whether the switches are correctly set.

- Check all the plugs to the HARDI TRONIC for breakage, dirt, moisture or corrosion.

- Check all wire connections out to each sensor for breakage or damage.

- Replace batteries, if necessary.



Flowmeter

Display shows no flow (l/min Gpm)

- Check that the mill-wheel can rotate easily.
- Remove the flowmeter from the casing and activate the mill-wheel by blowing or using a finger so it rotates. Check at the same time on the right-hand display whether the HARDI TRONIC receives impulses

Speed Sensor

Display shows no speed (km/h mph)

- Test the speed sensor by passing a magnet in front of the sensor. Check at the same time on the right-hand display whether the HARDI TRONIC receives impulses.

Display shows variation in speed while driving evenly (km/h mph)

- Check whether mud or dirt are covering the wheel magnets and speed sensor.
- Magnets and sensor must be clean.
- Check that all magnets are there.
- Check the distance between the magnets and sensor. The distance must be between 5 - 7 mm.

Pressure Transducer

Display shows no pressure

- Disconnect the pressure transducer from the boom tube. Rinse for chemical sediments, if any. Must be completely clean.
- Check wire connections in junction box on the central section for loose ends.

Area Switch



Area switch continuous to count in off position

- Check the distance between the area switch and the magnet. The distance must be between 5 - 7 mm.
- Magnet and sensor must be cleaned for dirt.
- The sensor and magnet must be moved at least 20 mm away from each other before the area counting starts.

Power Supply Box

No function on EC-operating unit or hydraulic valves

- Check the cable to the tractor 12 Volt system. Blue wire to the negative terminal (-) and brown on to the positive terminal (+).
- Check cable and multi plug from power supply box to operating unit or hydraulic valves for corrosion etc.
- The red light on the power supply box must flash when power is turned on to the HARDI TRONIC
- If the red light remains on constantly, this indicates that there is no power to the HARDI TRONIC which means no function on operating unit and hydraulic valves.
- Remove the lid on power supply box and check the fuse, operating unit (500 mA), hydraulic valves (6.3 A).
- **IMPORTANT:** Do not hand operate the operating unit before the power is turned off.

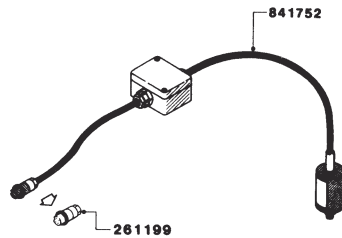
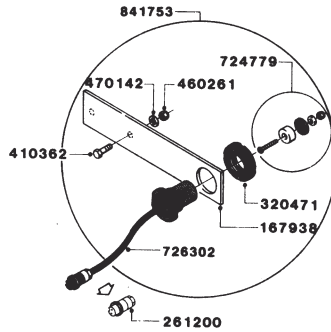
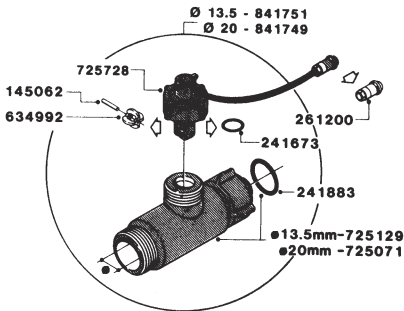
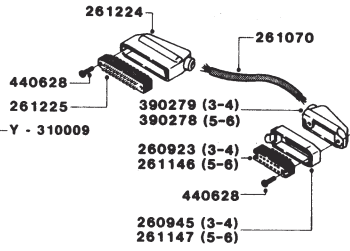
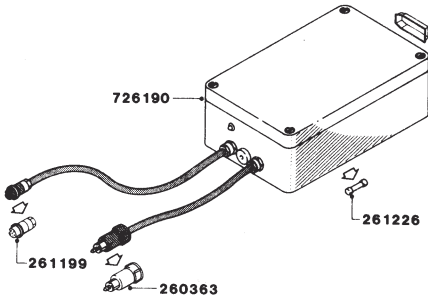
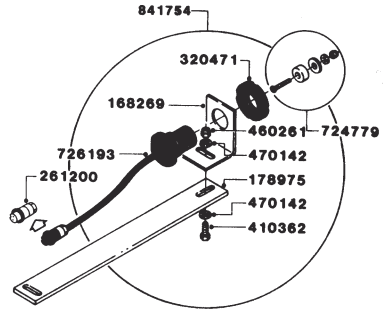
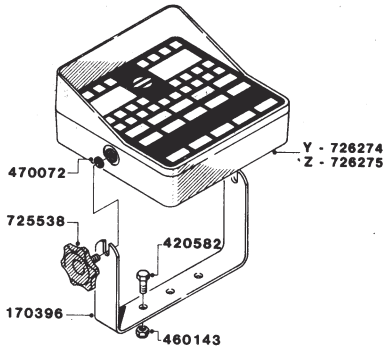

16-10-87

E33

Assembly Instructions for HARDI TRONIC 2000

Fitting of Flowmeter on EC-Operating Unit



When fitting the flowmeter to the EC-operating unit dismantle the unit part, consisting of the pressure regulating valve and the on/off valve, from the sectional valves and the operating unit bracket.

The flowmeter is installed.

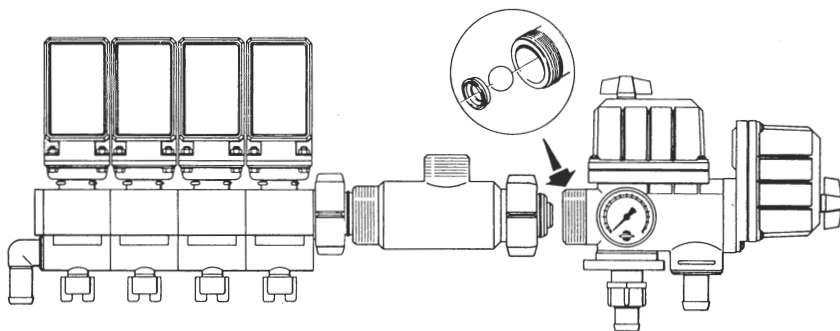

IMPORTANT: It is important that ball and ball seat are correctly fitted.



Lubricate O-rings before fitting flowmeter.

Fix operating unit to its bracket.



Fitting of Magnets on Wheel Rim

With rim sizes up to a diameter of 20" 4 magnets are fitted. With rim sizes above 20" 6 magnets are fitted. It is important that the distance between all magnets is the same. The distance must not be smaller than 150 mm between two magnets. 4.5 mm holes are bored in the rim plate. Enclosed paper model can be used for marking-off the 4.5 mm holes.

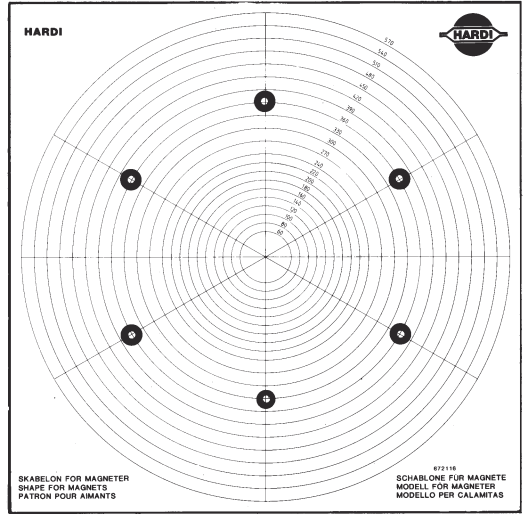

Installation of Speed Sensor

The speed sensor bracket is adapted and fitted to the machine so that the magnets will pass the speed sensor at a distance of 5 - 7 mm. If the speed sensor bracket is to be welded to the tractor, remember to disconnect the wires from the tractor battery.

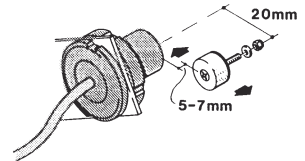

Installation of Pressure Transducer



Fit the pressure transducer at the end of a boom tube.

A.
Choose one on the central section. Lubricate the O-ring before fitting the pressure transducer to the boom tube.

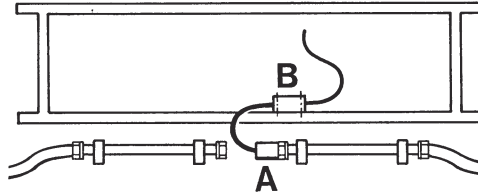

B.
Fasten the junction box on to the central section. Drill two 3.5 mm holes. Dismantle the cover of the box and mark off the holes.

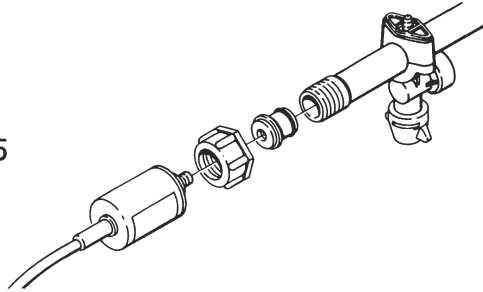

Installation of Area Switch

This switch is used in connection with other implements and can be installed at different locations depending on the type of implement.

The area switch can be fitted at

- the lift function of the tractor
- engaging lever for PTO shaft
- on/off function of the implement
- lift/lowering function of the semi-mounted implements

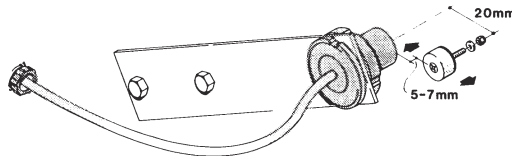



To stop the area signals, magnet and sensor must be precisely opposite each other. In this position the distance must be between 5 and 7 mm (distance between sensor and magnet). To start area signals the magnet must be moved at least 20 mm away from the centre of the sensor.

Installation of Power Supply Box

Fit the power supply box in a suitable place inside the tractor cab in such a way that the plugs from the operating unit and hydraulic valves can easily be connected.

Connect the power supply box to the 12 V system of the tractor. The brown wire to be connected to the positive terminal (+) and the blue one to the negative terminal (-).

Fitting of Processor Control Unit

Fit the processor control unit in a suitable place in the tractor cab so reading of display and keying are easily done.

Fit the bracket so the plugs on the back of the HARDI TRO-NIC can easily be connected.

