



## **MEGA 230 /350 CENTRIFUGAL OPERATORS MANUAL**

Part No. 105459 3/96

HARDI reserves the right to make changes in design,  
material, or specification without notice thereof.

**HARDI MEGA 230 / 350 CENTRIFUGAL OPERATORS MANUAL**

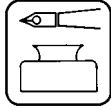

## TABLE OF CONTENTS

<b>1.0 INTRODUCTION</b>	<b>7</b>
<b>2.0 SAFETY INFORMATION</b>	<b>8</b>
2.1 Follow Safety Instructions	9
2.2 Operating the Sprayer Safely	9
2.3 Handling Chemical Products Safely	11
2.4 Local Poison Information Center	12
<b>3.0 GLOSSARY OF TERMS</b>	<b>13</b>
<b>4.0 ASSEMBLING THE MEGA SPRAYER</b>	<b>14</b>
4.1 Lifting points	14
4.2 Preparing Wings for Installation	15
4.3 Installing Boom Wings	15
4.4 Mounting Hydraulic Hoses	16
4.5 Installing Center Frame Spray Tube Assembly	18
4.6 Adjusting Center Cables	19
4.7 Attaching Feed Hoses - Three Valve System	20
4.8 Performing Final Inspection	21
<b>5.0 MOUNTING THE MEGA SPRAYER</b>	<b>22</b>
5.1 Dismounting the Mega Sprayer	23
5.2 P.T.O. Shaft Operator Safety	24
5.3 Installation of P.T.O. Shaft	24
5.4 Hydraulic Requirements with Eagle Boom	27
5.5 Hydraulic Hook-Up	27
5.6 HZ Hydraulics	28
5.7 Installation of Handle	28
5.8 Electric Hook-Up of Handle	28
5.9 Control Box for E.S.C. Controls	29
<b>6.0 OPERATING INSTRUCTIONS</b>	<b>30</b>
6.1 Filling the Main Tank	30
6.2 Filling the Flush Tanks	30
6.3 Standard Sprayer Plumbing Diagram	30
6.4 Operating The Mega Boom	31
6.5 Unfolding & Folding the Boom (HY Hydraulics)	31
6.6 Unfolding & Folding the Boom (HZ Hydraulics)	32
6.7 Tilting the Boom (HZ Models Only)	32

## TABLE OF CONTENTS: Continued

<b>6.0 OPERATING INSTRUCTIONS (cont'd)</b>	
6.8 Operation of the ESC Controls	33
6.9 Agitation Adjustment	35
6.10 Manifold System	36
6.11 Manifold System Operating Instructions	38
6.12 Agitation Bypass Valve Operation (Optional)	39
6.13 Operation of the Tank Drain Valve	39
6.14 Nozzle Selection	41
6.15 Calibration	44
<b>7.0 MAINTENANCE</b>	<b>48</b>
7.1 Cleaning the Sprayer	48
7.2 Filters	50
7.3 Lubrication	51
7.4 Greasing the H-Frame & Center Frame	52
7.5 Greasing the Boom	53
7.6 Lubrication of Chain & Sprocket	54
7.7 Greasing the Breakaway Clutch	54
7.8 Maintenance of Triplets	55
<b>8.0 ADJUSTMENTS</b>	<b>56</b>
8.1 Adjustment & Maintenance Intervals	56
8.2 Checking and Adjusting Sprocket Timing	57
8.3 Aligning Wing Assemblies	57
8.4 Aligning Intermediate and Outer Boom Sections	58
8.5 Adjusting Front Fold Cables	59
8.6 Adjusting Breakaway Clutch Tension	60
8.7 Adjusting Boom Wing to be Level	61
8.8 Adjusting Floating Frame Pivots	63
8.9 Adjusting Boom Transport Position	64
8.10 Adjusting Rear Cable	64
<b>9.0 WINTER STORAGE</b>	<b>65</b>
<b>10.0 OPERATIONAL PROBLEMS</b>	<b>66</b>
10.1 Nozzle Tubes and Fittings	67
10.2 Checking the Valve Cone in Distributor Valves	67

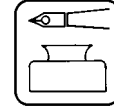



## TABLE OF CONTENTS: Continued

<b>10.0 OPERATIONAL PROBLEMS (cont'd)</b>	
10.3 Emergency Operation of E.S.C. Control	68
10.4 Level Indicator	68
<b>11.0 TROUBLESHOOTING</b>	<b>69</b>
11.1 General Spray Systems	69
11.2 Foam Marker	71
11.3 Flush & Rinse™	72
11.4 Chemical Filler	72
11.5 Hydraulics	73
11.6 HY Hydraulics - Schematic	74
11.7 HZ Hydraulics - Schematic	75
<b>12.0 ACCESSORIES</b>	<b>76</b>
12.1 Chemical Filler	76
12.2 Chemical Filler Rinse Kit	76
12.3 Flush System	77
12.4 Tank Rinse System	78
12.5 Foam Marker System	79
12.6 Nurse Tank Quick Fill	80
12.7 Front Tank	80
12.8 Suction Filter	81
12.9 Agitation Shut-Off Valve	81
<b>13.0 WARRANTY POLICY AND CONDITIONS</b>	<b>82</b>



Dear Owner,

Thank you for purchasing a HARDI product and welcome to the ever-increasing family of HARDI sprayer owners.

Our sprayers and accessories are rapidly becoming a familiar sight on North American farms. We believe that this results from growers becoming increasingly conscious of crop protection input costs and the vital need for cost effective spray application equipment.

Please take the time to thoroughly read the Operator's Manual before using your equipment. You will find many helpful hints as well as important safety and operation information.

Some of the features on your HARDI sprayer were suggested by growers. There is no substitute for "on farm" experience and we invite your comments and suggestions.

Please address your correspondence to the Service Manager at one of these branches:

HARDI MIDWEST  
1500 West 76th St.  
Davenport, Iowa 52806  
Phone: (319) 386-1730

HARDI GREAT LAKES  
290 Sovereign Rd.  
London, Ontario N6M 1B3  
Phone: (519) 659-2771

Sincerely,

A handwritten signature in black ink, appearing to read "Tom L. Kinzenbaw".

Tom L. Kinzenbaw  
President



*Fig. 1*  
*MEGA 350 W/ 60' EAGLE BOOM*



*Fig. 2*  
*MEGA 350 W/ 60' EAGLE BOOM*

## 1.0 INTRODUCTION

The HARDI MEGA models consist of a pump, frame with a tank that has either 230 or 350 gallon capacities, ESC-Controls (Electric Control), Manifold system, P.T.O. shaft and a 60' hydraulic folding Eagle series spray boom. The 230 gallon model will mount directly to a category II & III 3-point hitch as well as to a category II and category III quick hitch. The 350 gallon model will mount directly to a category III 3-point hitch and category III & category IIIN quick hitch. A pin kit is available for mounting the 350 gallon to category II 3-point link arms.

The tank, made of impact-proof and chemical resistant polyethylene, has a purposeful design with no sharp corners, for easy cleaning. A large, easy to read tank contents indicator is placed in front of the tank. A step and platform is placed at the right hand side of the sprayer for easy access to the tank filling hole.

The ESC (electric control) unit consists of: on/off control valve, pressure regulating valve, pressure gauge and distribution valves with pressure equalization feature.

The "Manifold System" features color coded three way valves on suction and pressure sides of the liquid control system. It allows for safe and simple use of the sprayer and accessories from one position. The Self-Cleaning Filter screens out impurities from the spray solution which are recirculated back to the main tank while clean solution is constantly being supplied to the boom.

The Eagle hydraulic series boom is available with either 3(HY model) or 5 (HZ model) hydraulic cylinders. The base version being the HY model, includes boom height adjustment and fold/unfold features all controlled from the tractor. The HZ model has all the same features as the HY model but also includes individual wing tilt and fold as added features. Both versions require single and double acting hydraulic outlets on the tractor as well as a 12V connection for the HZ model.





## 2.0 SAFETY INFORMATION

### WARNING



**ALWAYS READ OPERATORS MANUAL BEFORE  
USING EQUIPMENT**

**DO NOT REMOVE ANY SAFETY DEVICES OR  
SHIELDS. NEVER SERVICE, CLEAN OR REPAIR A  
MACHINE WHILE IT IS OPERATING**

### WARNING



**ALWAYS WATCH FOR THIS SYMBOL TO POINT OUT  
IMPORTANT SAFETY PRECAUTIONS**

**IT MEANS ATTENTION! BECOME ALERT!  
YOUR SAFETY IS INVOLVED!**





## RECOGNIZE SAFETY INFORMATION

**This is the Safety-alert symbol. When you see this symbol on your machine or in this manual, be alert to the potential for personal injury.**

**Follow recommended precautions and safe operating practices.**



### 2.1 Follow Safety Instructions

- Carefully read all the safety messages in this manual and the safety labels fitted to the machine. Keep safety labels in good condition. Replace missing or damaged safety labels. Be sure that new equipment components include any current safety labels. Replacement safety labels are available from your authorized HARDI dealer.
- Learn how to operate the sprayer and how to use the controls properly. Do not let anyone operate the sprayer without proper instructions.
- Keep your sprayer in proper working condition. Unauthorized modifications or use may impair the function and/or safety and affect the machines life.
- If you do not understand any part of this manual and need assistance, please contact your authorized HARDI dealer.

### 2.2 Operating The Sprayer Safely

1. Read the complete manual carefully and become familiar with the operation of the equipment before initial operation in each spraying season. Failure to do so may result in possible over or under application of spray solution which may drastically affect crop production and/or lead to personal injury.
2. Before starting the engine on the tractor unit, be sure all operating controls are in the off or neutral position, including but not limited to the P.T.O. shaft and/or spray controls. Be sure the tractor power train is disengaged.
3. Operate spray and boom functions only when seated in the Operator's seat.



## 2.2 Operating The Sprayer Safely (cont'd)

4. One of the most frequent causes of personal injury or death results from persons falling off or being run over. Do not permit others to ride on or in. Only one person - the operator - should be in the tractor when in operation.
5. Before leaving the tractor seat, stop the engine, put all controls in neutral, and put the transmission control lever in the park position or neutral with the brakes locked. Read the tractor operations manual for added safety precautions.
6. PTO driven equipment can cause serious injury. Before working on or near the P.T.O. shaft, servicing or cleaning the equipment, put PTO lever in the DISENGAGE position and stop the engine.
7. Do not fold or unfold boom near overhead wires. Serious injury or death could result if contact is made with electric wires.
8. Keep hands, feet & clothing away from moving parts.
9. Wear relatively tight and belted clothing to prevent from being caught on some part of the machine.
10. Slow down when turning especially with boom extended.
11. Always keep children away from your sprayer and/or tractor unit.
12. Before transporting the sprayer ensure that the boom is fully folded and fully locked into transport position. Ensure all locking devices are fully engaged whether hydraulic or mechanical.
13. Slow moving tractors and spray equipment can create a hazard when on public roads. Avoid personal injury or death resulting from any accidents by using flashing lights. Local regulations may require installation of flashing warning lights.
14. Avoid injuries from high pressure fluids penetrating the skin by relieving system pressure before disconnecting hydraulics or other lines. Ensure all fittings are tight before applying pressure to the system.

## 2.2 Operating The Sprayer Safely (cont'd)

15. Understand service procedures before undertaking any maintenance. Never lubricate, service, or adjust the machine while its moving. Securely support any components before working on them.
16. Keep all parts in good condition and properly installed. Fix damaged parts immediately. Replace worn or broken parts. Remove excessive buildup of grease, oil, or debris.

## 2.3 Handling Chemical Products Safely

1. Direct exposure to hazardous chemicals can cause serious injury. These chemicals can include lubricants, coolants, paints, adhesives and agricultural chemicals. Material safety data sheets (M.S.D.S.) are available for all hazardous chemicals which inform the user of specific details including, physical and health hazards, safety procedures, and emergency response techniques.
2. Protective clothing such as rubber gloves, goggles, coveralls and respirator must be worn while handling chemicals. All protective clothing should be kept in excellent condition and cleaned regularly or discarded.
3. If chemicals come in contact with any exposed skin areas, wash immediately with clean water and detergent. Never place nozzle tips or any other components that have been exposed to chemicals to lips to blow out obstructions. Use a soft brush to clean spray nozzles.
4. Dedicate an area to fill, flush, calibrate and decontaminate sprayer where chemicals will not drift or run off to contaminate people, animals, vegetation, water supply, etc. Locate this area where there is virtually no chance of children being in contact with this residue.
5. Decontaminate equipment used in mixing, transferring, and applying chemicals after use. Follow the instructions on the chemical label for the correct procedure required. Wash spray residue from outside of the sprayer to prevent corrosion.





### 2.3 Handling Chemical Products Safely (cont'd)

6. Extreme care should be taken in measuring spray products. Powders should be used in suitable sized packages or weighed accurately. Liquids should be poured into a suitable graduated container. Keep chemical containers low when pouring. Wear a filtered respirator and let the wind blow away from you to avoid dust and/or splashes contacting the skin or hair.
7. Store chemicals in a separate, plainly marked locked building. Keep the chemical in its original container with the label intact.
8. Dispose all empty containers after rinsing in accordance with local regulations & by-laws. Dispose of all unused chemicals and left over fertilizer in an approved manner
9. Keep a first aid kit and fire extinguisher available at all times when handling chemicals.



### 2.4 Local Poison Information Center

PHONE NO. \_\_\_\_ - \_\_\_\_ - \_\_\_\_\_

Find the phone number for the poison control center in your phone book and write it in the space above.

Keep a list, in the space provided below, of all the chemicals that you have in use.

1. \_\_\_\_\_
2. \_\_\_\_\_
3. \_\_\_\_\_
4. \_\_\_\_\_
5. \_\_\_\_\_
6. \_\_\_\_\_
7. \_\_\_\_\_
8. \_\_\_\_\_
9. \_\_\_\_\_
10. \_\_\_\_\_

### 3.0 GLOSSARY

RIGHT HAND and  
LEFT HAND SIDES

Are determined by facing the forward direction of travel.

FOLDED BOOM

Refers to the boom in transport position.

UNFOLDED BOOM

Refers to the boom in spray position.

WING

Refers to the folding portion of the boom

CENTER

Refers to the portion of the boom that the wings attach to. The wings move up and down with the center.

INNER WING

Refers to the inner portion of the boom.

OUTER WING

Refers to the outer portion of the boom.

BREAKAWAY

Refers to the device between the inner wing and the outer wing that allows the outer wing to swing backward if an obstacle is encountered.





## 4.0 ASSEMBLING THE MEGA SPRAYER



**USE PROPER LIFTING EQUIPMENT  
LIFTING HEAVY EQUIPMENT INCORRECTLY CAN CAUSE  
PERSONAL INJURY OR MACHINE DAMAGE.  
FOLLOW ALL RECOMMENDED PROCEDURES FOR REMOVAL  
AND INSTALLATION OF COMPONENTS IN THE MANUAL.**

### 4.1 Lifting Points

When loading or unloading the sprayer from a truck or trailer use the lifting points as shown.

The Mega Sprayer is shipped in 4 parts for ease of transportation:

1. Tank & frame assembly
2. Wing assembly RH
3. Wing assembly LH
4. Boom mount kit

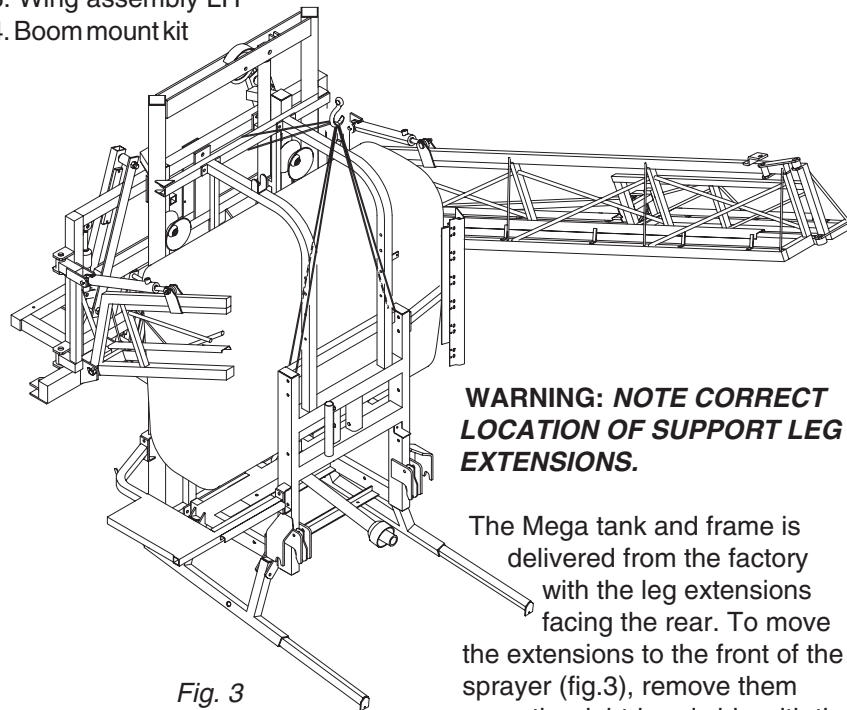

Fig. 3

**WARNING: NOTE CORRECT  
LOCATION OF SUPPORT LEG  
EXTENSIONS.**

The Mega tank and frame is delivered from the factory with the leg extensions facing the rear. To move the extensions to the front of the sprayer (fig.3), remove them swap the right-hand side with the left-hand side and refit.

## 4.2 Preparing Wings For Installation

**CAUTION:** For safe handling, tie inner & outer boom sections together to prevent accidental unfold during installation.

1. Tie outer boom sections to inner section.
2. Attach lifting chain at lift point (A) on inner boom section. Position chain between vertical and angled boom members so chain does not move from this point when boom is lifted.

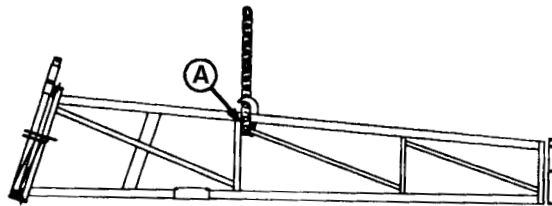

Fig. 4

## 4.3 Installing Boom Wings

**CAUTION!** Before installing wings, ensure that the stands are lowered and that the leg extensions on Mega frame are extended forward.

- 1a. HY BOOM - Fit nut (qty. 1), washers (qty. 2), to the threaded end of the tie rod. Fit the rod under tab on mount plates on center frame. Fit remaining washers and lock nut to the rods.

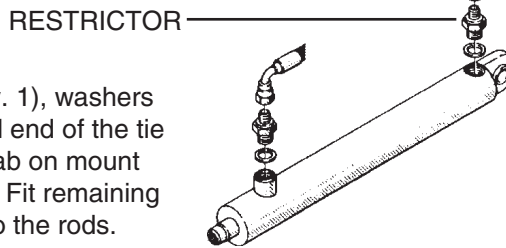

Fig.5

- 1b. HZ BOOM - Attach tilt cylinders to center frame using pins and cotter pins. Remove plugs from cylinder ports and manually extend cylinders to their full extension. Install o-ring washers and restrictor fittings in both ports on hydraulic cylinders. The restrictor with the small hole is fitted to the fixed (base) end of the hydraulic cylinder. (Refer to fig. 5)





### 4.3 Installing Boom Wings (cont'd)

2. Position boom hinge on center frame with folded boom sections to the front.
3. Attach tie rod/tilt cylinder to hinge using pin and cotter pins.
4. Line up lower hinge pin holes and insert pin. Insert threaded pin from the front through the center frame and hinge and retain with lock nut.
5. Attach safety chain from center section to extended pin on upper end of hydraulic cylinder - Fit locking ring to pin. This will prevent boom sections from accidentally unfolding during installation. (Refer to fig. 6)
6. Repeat steps 3-6 for other wing.
7. Attach equalizer cables to inner boom sections using M12x50mm bolts and lock nuts.
8. Install o-ring washers and restrictor fittings in both ports of hydraulic fold cylinders. Restrictor with the small hole goes in the fixed (base) end of the hydraulic cylinder. (Fig. 5)

### 4.4 Mounting Hydraulic Hoses



**BE SURE TO HOOK UP HYDRAULIC LINES PROPERLY!  
ENSURE HYDRAULIC LINES HAVE NOT BEEN DAMAGED DURING SHIPMENT.**



**ESCAPING HYDRAULIC FLUID UNDER PRESSURE CAN PENETRATE THE SKIN CAUSING SERIOUS INJURY. AVOID THIS HAZARD BY RELIEVING PRESSURE BEFORE DISCONNECTING HYDRAULIC LINES.  
ENSURE ALL CONNECTIONS ARE TIGHT BEFORE APPLYING PRESSURE, SEARCH FOR LEAKS WITH A PIECE OF CARDBOARD NOT YOUR HANDS!**

#### **A/ FOLD CYLINDERS**

1. Route hydraulic hoses to fold cylinders through the hose support bracket **A** (Fig. 6). (Refer to section 11 for hydraulic schematics)
2. Attach hydraulic hoses from right hand side of hydraulic block on center section to port on the hinge base end of hydraulic fold cylinders.(Hy Hydraulics Only)
3. Attach hydraulic hoses from left hand side of hydraulic block on center section to the other port on the hydraulic fold cylinders.(Hy Hydraulics Only)



#### 4.4 Mounting Hydraulic Hoses (cont'd)

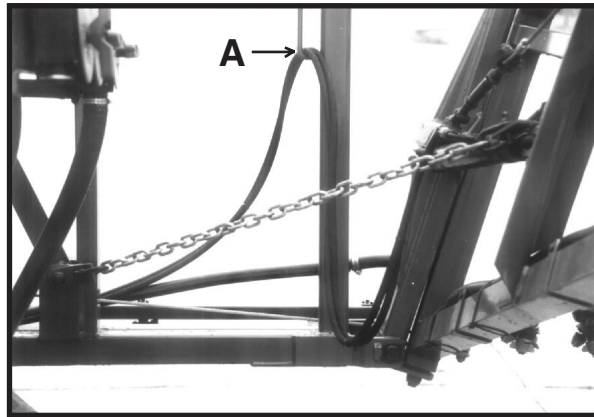

Fig.6



4. Disconnect fold cylinder rod (adjustable eye end) from wing section.
5. Ensure cylinder is free of obstruction for retraction and extension.
6. Connect hydraulic hoses to double acting outlet on tractor. (Refer to section 11 for hydraulic schematics)
7. Start tractor engine and cycle fold cylinders by actuating double acting outlet 10 times to bleed air from hydraulic system.
8. Stop tractor engine, check hydraulic reservoir oil level and fill as necessary.
9. Attach fold cylinder rods to boom sections, using previously removed pins and cotter pins.

#### **B/ TILT CYLINDERS**

1. If hydraulic tilt cylinders are fitted to the spray boom, air should be bled from these lines before spraying.
2. Disconnect tilt cylinder rod eyes from wing section.



#### 4.4 Mounting Hydraulic Hoses (cont'd)

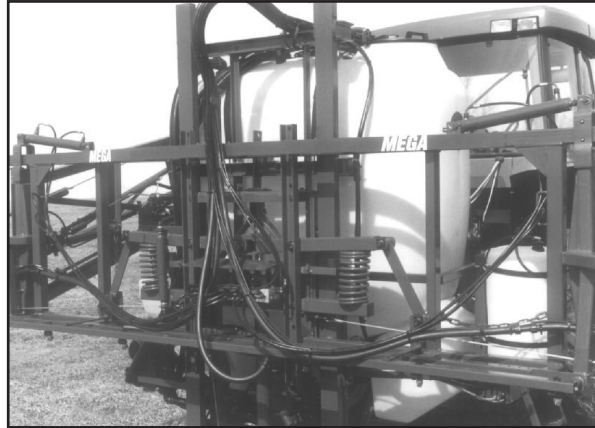

Fig. 7



**CAUTION!** *Wing section must be supported before removal of hydraulic cylinder rod eyes.*

3. Ensure cylinder is free of obstruction for retraction and extension.
4. Start tractor engine and cycle tilt cylinder by actuating double acting outlet 10 times to bleed air from hydraulic cylinders.
5. Stop tractor engine, check hydraulic reservoir oil level and fill as necessary.
6. Reattach tilt cylinder rods to boom sections.

#### 4.5 Installing Center Frame Spray Tube Assembly

1. Attach brackets to center frame using M6x30mm cap screws and lock nuts.

**NOTE:** *To gain access to mounting holes on the nozzle track, remove plastic nozzle retaining nuts closest to mount holes and remove tube as necessary to install cap screws from the bottom.*

2. Attach spray tube assembly using M6x20mm cap screws with lock nuts on top. The 4 nozzle tube is to be on the right-hand side.

## 4.6 Adjusting Center Cables

**NEVER ATTEMPT TO ADJUST THE CENTER CABLES WITHOUT HAVING THE BOOM FOLDED ALL THE WAY INTO THE TRANSPORT POSITION!**

The center cables work together to keep the floating frame square to the stationary frame, while folding the boom in for transport or when spraying with one side raised and folded.

1. Fold boom into transport position.
2. Shut the tractor off.
3. Check that tilt cylinders are COMPLETELY EXTENDED. Adjust if necessary.
4. Loosen jam nuts. (B).

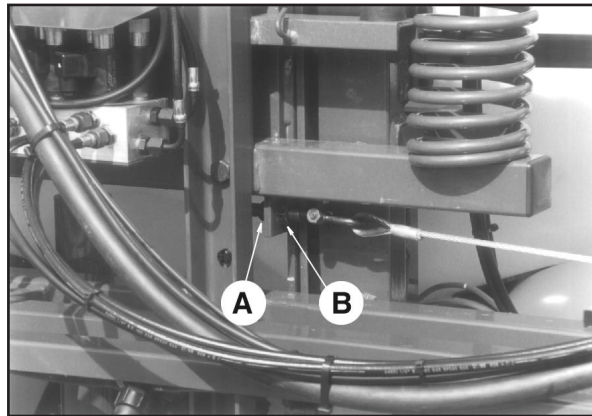

Fig. 8

**IMPORTANT:** *Alternate from side-to-side while making adjustments. Adjust one cable a small amount, and then the other, to equalize cable tension and maintain a level center frame.*





#### 4.6 Adjusting Center Cables (cont'd)

5. Alternating from side-to-side, tighten adjustment nuts (A) so floating frame is square with stationary frame. Properly adjusted cables will be very tight and only deflect a small amount (fractions of an inch) when pulled on by hand. **DO NOT overtighten cables.**
6. Tighten jam nuts (B).
7. Unfold boom to operating (spraying) position.
8. Fold boom and check that floating frame remains square to stationary frame.

#### 4.7 Attaching Feed Hoses - Three Valve System



**IMPORTANT:** *DO NOT use petroleum based lubricants. They will deteriorate hoses, causing them to weaken and leak. Lubricate hose ends with liquid dish soap to make installation easier.*

*To avoid rework, be sure of fitting locations prior to attaching hoses. Plastic fittings use a very aggressive hose barb which makes hose removal difficult.*

1. Route hoses from each boom section to control valve.



**IMPORTANT:** *Ensure feed hoses have sufficient slack around hinge to prevent hose binding when boom is folded. Feed hoses should be routed over the H-frame and strapped to the support bracket with enough slack to ensure that there is no binding when boom is lowered or raised. (Fig. 9)*

2. Connect feed hoses to control valves. Right hand feed hose goes to right hand section control valve.
3. Retain all hoses with tie straps.

#### 4.7 Attaching Feed Hoses (cont'd)



*Fig. 9*

#### 4.8 Performing Final Inspection

1. Check hydraulic system for leaks.
2. Check hydraulic hoses for clearance and freedom of movement throughout entire range of operation.
3. Check feed hoses for freedom of movement through out range of operation
4. Lubricate all machine lubrication points. (Refer to section 7)
5. Adjust machine for field operation. (Refer to section 8)
6. Ensure all fasteners are tightened correctly.

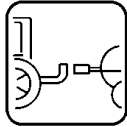

## 5.0 Mounting The Mega Sprayer

The sprayer is designed for three point mounting on a tractor and will fit category II & III hitch depending on the sprayer model purchased. The frame has support legs (for use when the sprayer is free standing) that can be folded up to minimize crop damage.



**Caution! The retractable support legs (F) are spring-loaded, to avoid injury be careful during folding/unfolding of the support legs.**

To mount the sprayer proceed as follows:

1. Connect lift arms or quick hitch to sprayer.
2. Lift the sprayer, checking that no part of the sprayer contacts the tractor.
3. Adjust the three point lift so the boom is at 18" to 20" above ground when the boom lift cylinder is at it's minimum height.
4. Retract the support leg extensions(A) and fold the legs up under the sprayer frame.
5. Adjust the top link bar so that the sprayer frame and tank are perpendicular to the ground.
6. Do not connect P.T.O. shaft until operating shaft clearance Fig. 10 has been determined (Refer to section 5.2)

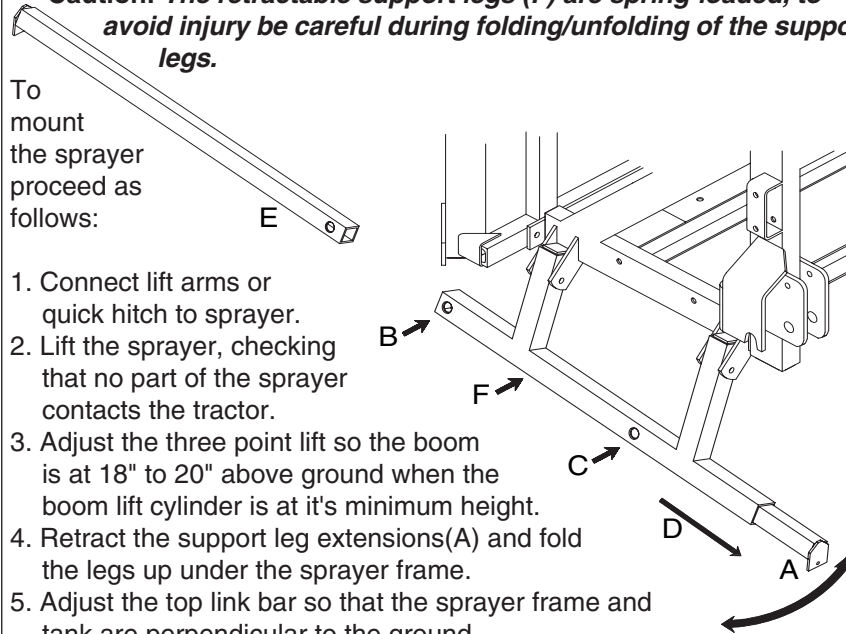

**WARNING: NOTE THE WEIGHT OF THE SPRAYER. GENERAL RECOMMENDATION ARE AS FOLLOWS:**

- Add ballast weights to front of the tractor.
- Increase tyre pressure if necessary(see tractor instruction book)
- Be careful when filling/lifting the sprayer for the first time.
- Ensure that any part of the sprayer and tractor do not touch.
- Travel at slower speeds when driving with a full tank. (The tractor braking effect will be reduced.)

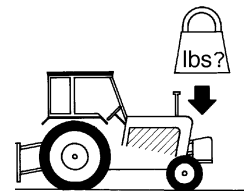

## 5.1 Dismounting The Mega Sprayer

To dismount the sprayer, proceed as follows:

The retractable support legs must be folded down and extended before lowering and dismantling the sprayer. Proceed as follows:(fig. 10)

1. Swing support legs down.
2. Push the black button **B** in.
3. Extend the legs **A** until the black button clicks out in location hole **C**.

### **WARNING! NOTE CORRECT LOCATION OF SUPPORT LEG EXTENSIONS**

When the boom is **folded** in **transport position** the support leg extensions must be placed and extended at the **front** of the sprayer **D**.

When the boom is **unfolded**, the support leg extensions must be placed and extended at the **back** of the sprayer **E**.

4. Lower the sprayer (Be aware of P.T.O. Shaft angle)
5. Disconnect top bar, stop engine and disconnect PTO-shaft, hydraulics and electric cables.
6. Disconnect lower link arms or remove quick hitch from sprayer.



## 5.2 P.T.O. Shaft Operator Safety



**WARNING: ALWAYS STOP ENGINE BEFORE ATTACHING THE TRANSMISSION SHAFT TO TRACTOR P.T.O. - MOST TRACTOR P.T.O. SHAFTS CAN BE ROTATED BY HAND TO FACILLITATE SPLINE ALIGNMENT, WHEN ENGINE IS STOPPED.**

When attaching the shaft, make sure that the snap lock is FULLY ENGAGED - push and pull shaft until it locks.



**WARNING: ROTATING TRANSMISSION SHAFTS WITHOUT PROTECTION GUARDS ARE FATAL.**

Always keep protection guards and chains intact and make sure that it covers all rotating parts, including CV-joints at each end of the shaft. Do not use without protection guard.

Do not touch or stand on the transmission shaft when it is rotating - safety distance: min 5' (1.5 meters).

Prevent protection guards from rotating by attaching the chains allowing sufficient slack for turns.

Make sure that protection guards around tractor P.T.O. and implement shaft is intact.

Always STOP ENGINE and remove the ignition key before carrying out maintenance or repairs to the transmission shaft or implement.



## 5.3 Installation Of P.T.O. Shaft

**WARNING: THE P.T.O. SHAFT ANGLE WILL CHANGE CONSIDERABLY WHAN RAISING AND LOWERING THE SPRAYER ON THE 3-POINT LINKAGE.**

**TO PREVENT EXCESSIVE LOADING AND BINDING ON THE P.T.O. SHAFT, IT MAY BE ADVISABLE TO LEAVE THE P.T.O. SHAFT DISCONNECTED UNTIL PUMP OPERATION IS REQUIRED.**



Initial installation of the shaft is done as follows:

1. Attach sprayer to tractor and set sprayer in the position with **shortest** distance between the tractor and sprayer pump P.T.O. shafts.
2. Stop engine and remove ignition key.
3. If P.T.O. shaft must be shortened, the shaft is pulled apart. Fit the two shaft parts at tractor and sprayer pump and measure how much it is necessary to shorten the shaft. Mark the protection guards.

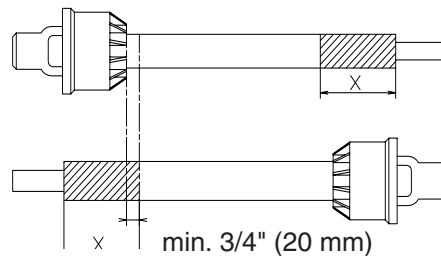

Fig. 11

**NOTE: The shaft must always have a minimum overlap of 6" (150 mm.)**

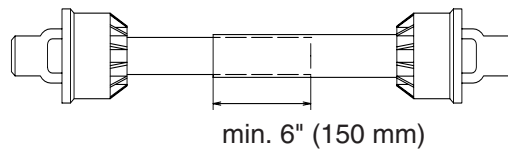

Fig. 12

4. The two parts are shortened equally. Use a saw, and file the profiles afterwards to remove burrs.
5. Grease the profiles, and assemble male and female parts again.

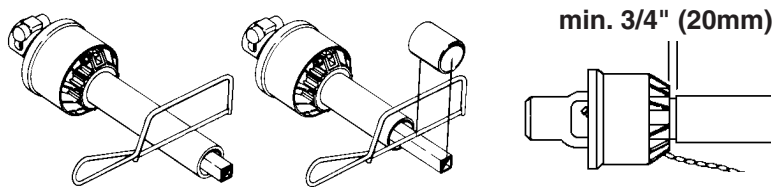
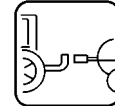
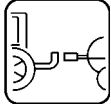

Fig. 13





6. Fit the shaft to tractor and sprayer pump.

**NOTE:** Female part towards tractor.

Fit the chains to prevent the protection guards to rotate with the shaft.

7. To ensure long life of the P.T.O. shaft, try to avoid working angles greater than 15°.

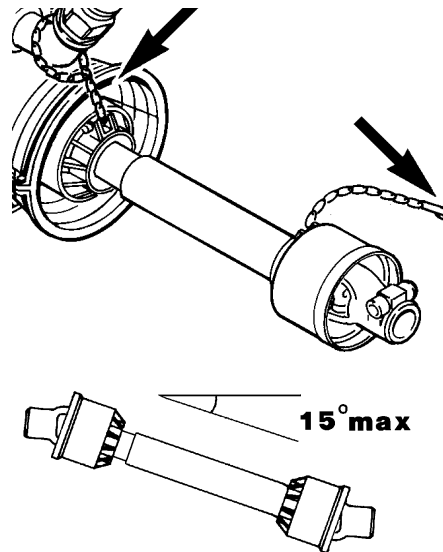
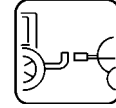

Fig. 14

## 5.4 Hydraulic Requirements with Eagle Boom

Hydraulic booms need one single outlet for the lift function of the spray boom and one double outlet for the folding function. Note that the hydraulic system requires an oil capacity of approximately .8 GPM (3 litres/min.) and a minimum pressure of 1,950 PSI (130 bar).



## 5.5 Hydraulic Hook-up

**BE SURE TO HOOK UP HYDRAULIC LINES PROPERLY!**

**ENSURE HYDRAULIC LINES HAVE NOT BEEN DAMAGED DURING SHIPPING.**



**ESCAPING HYDRAULIC FLUID UNDER PRESSURE CAN PENETRATE THE SKIN CAUSING SERIOUS INJURY. AVOID THIS HAZARD BY RELIEVING PRESSURE BEFORE DISCONNECTING HYDRAULIC LINES.**

**ENSURE ALL CONNECTIONS ARE TIGHT BEFORE APPLYING PRESSURE, SEARCH FOR LEAKS WITH A PIECE OF CARDBOARD NOT YOUR HANDS!**

**IMPROPER HOOK-UP CAN CAUSE DANGEROUS BOOM MOVEMENTS AND/OR DAMAGE TO THE SPRAYER HYDRAULICS.**

**DO NOT ALLOW ANYONE NEAR A HYDRAULIC BOOM IN OPERATION.**

**ALWAYS SHUT TRACTOR OFF WHEN CONNECTING, SERVICING OR ADJUSTING BOOM.**

1. Attach the heavier (3/8") hydraulic hose for the boom lift to the tractor's single acting outlet.
2. Attach the lighter (1/4") hydraulic hoses for boom folding & HZ tilt to the tractor's double acting outlet.

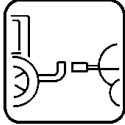

## 5.6 HZ HYDRAULICS

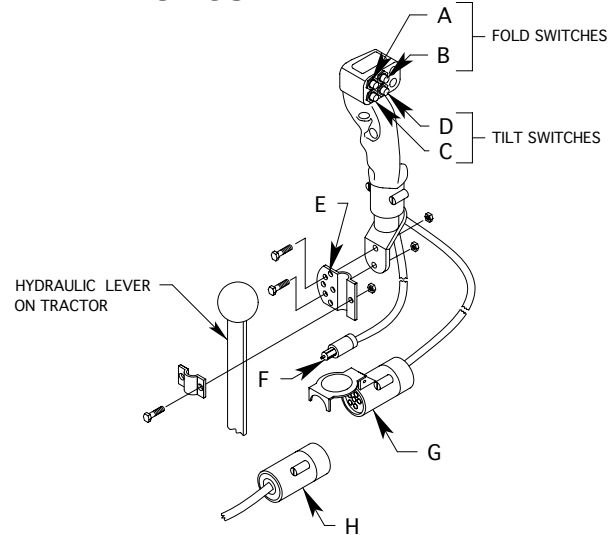

Fig. 15

## 5.7 Installation of Handle

The control handle should be attached to the hydraulic lever that operates the double acting outlet you intend to use. The universal mounting bracket "E" is very flexible and a number of different mounting positions can be used. Fig. 15 shows an example of how this may be done.

## 5.8 Electric Hook-up of Handle

1. Connect plug "F" to the tractor's 12 volt power system.

Note: Check with your dealer or tractor operators manual for the best location to hook up the 12 volt system.

Try to connect the power cable as close as possible to the battery or the starter of the tractor for a better power supply.

Brown wire on control handle is positive (+).

Blue wire on control handle is negative (-).

2. Connect electric plug "H" from sprayer hydraulics to plug "G" on handle.

## 5.9 Control Box for ESC-Controls

The control box for ESC-Controls should be mounted at a convenient place in the tractor cab. The control box has 4 screw holes in the back cover, which need to be drilled out for mounting on a flat surface, using the mount plate, bracket, and hardware furnished with the sprayer. Power requirement is 12V DC. There should be a 8amp fuse protecting this circuit. Note polarity. Brown pos. (+), Blue neg. (-)  
Brown pos. (+), Blue neg. (-)

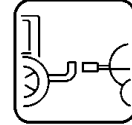

*Fig. 16  
(12-volt junction box for 12-volt hook-up for ESC controls, foam marker,  
boom hydraulic controls, etc)*

Use the optional HARDI Electric 12 volt outlet box (No. 817925) if more than one power outlet is required.

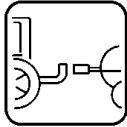

## 6.0 OPERATING INSTRUCTIONS

### 6.1 Filling the Main Tank

Water is filled into the tank by removing the tank lid located at right hand side of sprayer tank. It is recommended to use water as clean as possible for spraying purposes. Always fill water through the strainer basket to prevent foreign particles from entering the tank.



**WARNING:** *Do not let the filling hose enter the tank. Keep it outside the tank, pointing towards the filling hole (fig. 17). If the hose is lead into the tank and the water pressure drops at the water supply plant, chemicals may be syphoned back and contaminate the water supply lines, plant and well.*

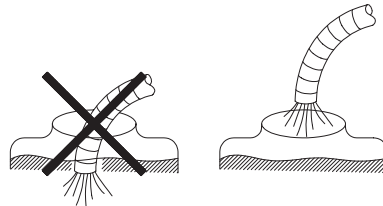

Fig. 17

### 6.2 Filling the Flush Tanks (if fitted)

Remove the tank lid, fill with clean water and replace lid.

### 6.3 Standard Sprayer Plumbing Diagram (Shown with optional Chemical Filler, Flush & Rinse™ System and Agitation shutoff valve)

Review and study the following diagram (Fig. 18). Following the flow through the system will help you better understand the various functions of the sprayer system.

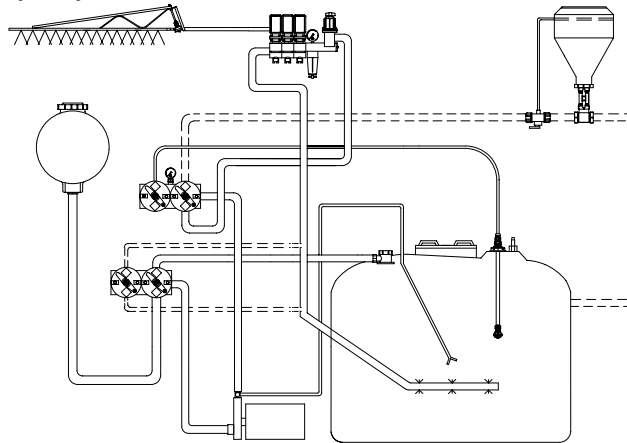

Fig. 18

## 6.4 Operating The Mega Boom

**ALWAYS OPERATE BOOM ON LEVEL GROUND. BEFORE UNFOLDING THE BOOM ENSURE THAT THE SPRAYER IS HITCHED TO THE TRACTOR UNIT.**

**ENSURE THAT THERE ARE NO OBSTRUCTIONS OR PERSONS IN THE PATH OF TRAVEL BEFORE FOLDING OR UNFOLDING THE BOOM.**

**ENSURE THAT THE SAFETY CHAINS ARE FITTED BETWEEN THE CENTER FRAME AND WING SECTIONS BEFORE TRANSPORTING AND STORING THE MEGA BOOM.**

## 6.5 Unfolding & Folding The Boom (HY-Hydraulics)

1. Start tractor and bring engine to operating RPM.
2. Activate the single acting outlet to lift the boom.  
**Note:** The boom has a rear transport configured as a hook in the center of the H-frame. This hook has to be released by lifting the boom with the single acting outlet until the control arm of the hook appears between the two flat bars of the hook guide.  
Be careful not to bring the control arm past the opening on the hook guide. See fig. 19
3. Disconnect safety chains from wings.
4. Activate the tractors double acting hydraulic lever to unfold the boom. Both wings will unfold simultaneously.
5. When boom is completely unfolded, it can be raised or lowered to desired spray height by activating the single acting hydraulic outlet.
6. Before attempting to fold boom back into transport position, it should be raised all the way to the top by activating the single acting outlet.  
**Note:** This time the control arm on the hook should be raised past the opening of the hook guide. See fig. 19
7. To fold the boom, actuate the double acting hydraulic lever.

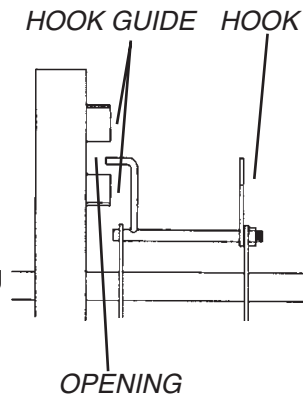

Fig. 19





When boom has been raised high enough for the control arm to go past the opening on the hook guide, the wings can be folded into transport position.

The boom is folded in by activating the double acting outlet. Ensure that the hook engages on the crossbar on the 'H-frame' (rear transport).

8. Reconnect the safety chains from the center section to the wing sections.

### **6.6 Unfolding and Folding Boom (HZ-Hydraulics)**

1. Depress switches "A" & "B" (See fig. 15) and move hydraulic handle forward or rearward to activate oil flow.

Switch positions of the hoses in the double acting outlet if the direction required to activate the boom needs to be reversed.

2. "One side folding" can be achieved by following the above procedure except that only one of the switches is depressed.



***ALWAYS PUT WING IN THE HORIZONTAL POSITION PRIOR TO FOLDING.***

***NEVER ATTEMPT TO FOLD BOOM TO TRANSPORT POSITION WHEN WINGS ARE TILTED. UNEXPECTED BOOM MOVEMENTS MAY OCCUR IF WINGS ARE TILTED WHEN FOLDING.***

### **6.7 Tilting Boom (HZ-Models Only)**

1. Depress switch "C" or "D" depending on what side needs to be tilted and move hydraulic handle forward or rearward to activate oil flow.



## 6.8 Operation Of The ESC Controls

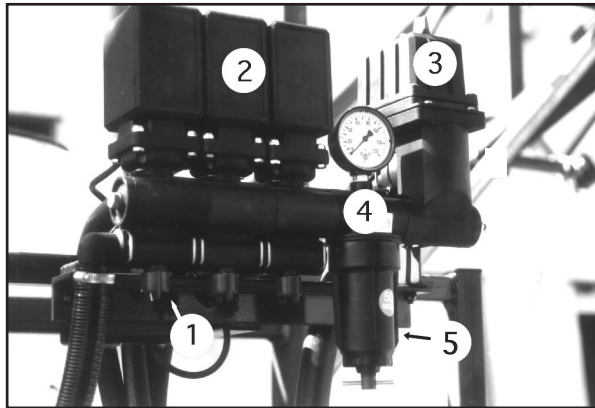

*Fig. 20*

1. Adjust screw for constant boom pressure
2. Distribution valve
3. Pressure regulating valve
4. Control unit pressure gauge
5. Pressure filter

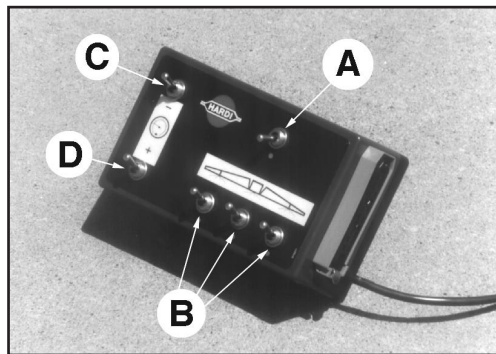

*Fig. 21*

- A. Master operating switch for on-off of valves
- B. Operating switches for distribution valves
- C. Pressure regulating switch (-) lower
- D. Pressure regulating switch (+) raise



## 6.8 Operation of the ESC- Controls (cont'd) (Fig. 20,21)

1. Choose the correct nozzle (Section 6.15). Make sure that all the nozzles are the same type and capacity.
2. Put the tractor in neutral and adjust the P.T.O. RPM's until the number of revolutions of the pump corresponds to the intended traveling speed. Remember the number of revolutions on the P.T.O. must be kept between 300-600 rpm.
3. Open or close knob 5 depending on whether pressure agitation is required. (Remember pressure agitation takes 5% to 10% of pump output).
4. On-off switch **A** is "ON" against green dot.
5. All distribution valves switch **B** are also "ON" against green dot.
6. Hold pressure regulating switch **C** to the (-) until handle **3**, stops rotating, this will be the "minimum pressure" setting.
7. Hold pressure regulating switch **D (+)** until desired pressure is shown on the pressure gauge.

**Note:** Adjust the constant distribution boom pressure one section at a time as follows: (Start with the valve turned closed before adjusting).

8. Shut-off the first boom distribution valve switch **B**. (Fig. 21)
9. Turn the adjusting screw **1** until the control unit pressure gauge (**7**) again shows the same pressure as set in step 6 above. (Turn the screw clockwise for higher pressure, counterclockwise for lower pressure).
10. Turn the first boom distribution valve switch **B** back on.
11. Repeat steps 7 through 9 for the two remaining boom distribution valves.

**Note:** Hereafter adjustment of the constant boom pressure will only be needed if you change to nozzles with other capacities, but not required if only changing pressure or application rate using the same nozzles.

12. Operating the control unit while driving: In order to shut off the entire boom activate on-off switch **A** (Fig. 21). This returns all the pump outputs to the tank through the return system. The diaphragm anti-drip valves ensures instantaneous closing of all nozzles.

In order to shut off one or more sections of the boom, switch one or more unneeded boom distribution valves **B** to off position. The constant pressure device ensures that the pressure does not increase in the sections which are still operating.



In case of electrical failure it is still possible to manually override all functions of the operating unit. To operate manually, disconnect the multiplug from the ESC control box first and operate the handles by hand. It is possible to change pressure, turn boom sections on or off, or shut off the complete control unit manually.

**IMPORTANT:** *When the sprayer is stored, the EC control box and the multiplug must be protected against moisture and dirt. A plastic bag may be used to protect the multiplug. Store the control box in a clean dry place.*

## 6.9 Agitation Adjustment (Agitation nozzles only)

Agitation is necessary to keep the solution in your tank properly mixed. Consult your chemical supplier for the recommended amount of agitation.

In general, maximum agitation is required but some products tend to foam easily. To reduce foaming in some instances anti-foaming agents may be added to the tank (Refer to chemical label). When running

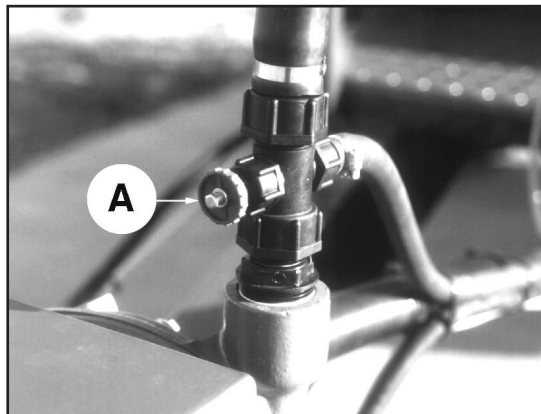

Fig. 22

low liquid levels in the tank, agitation may be reduced to facilitate pump priming and avoid pressure fluctuations. Make sure that you have adjusted the agitation properly before sprayer calibration.

Turning the Agitation Valve A clockwise will reduce the agitation flow. Turning the valve counter clockwise will increase the agitation flow.



## 6.10 Manifold System

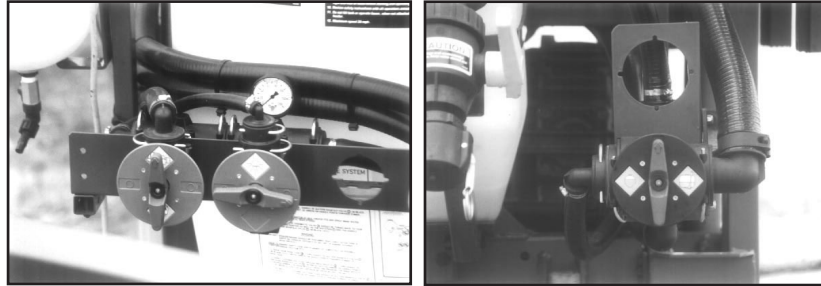

*Pressure Manifold*

*Suction Manifold*

*Fig. 23  
Standard Manifold Fittings*

The "Manifold System" is located at the left hand side of the sprayer permitting operation of most of the (fitted) accessories from one position.

The modular design of the Manifold system allows the easy addition of many accessories to the plumbing system of the sprayer. The system can be expanded to a maximum of 4 valves on the pressure side and 2 valves on the suction side. The system can also be fitted with an agitation bypass valve which ensures more complete drainage of the sprayer before cleaning or refilling.

The Manifold valve faces are colored discs for easy identification. The green face identifies the pressure manifold, the black disc identifies the suction manifold and a blue disc indicates the agitation bypass valve when fitted.

The green pressure valves and the black suction valves have 4 positions. Two positions are for options indicating that the valve will be open in this position. The other two are marked "O" indicating that the valve is closed. The blue return valve only has 2 positions. The arrow on the handle indicates which position is selected.

Symbols are fitted to the faces of the 3 way valves indicating direction of flow of the liquid.

An explanation of the symbols is as follows:

## 6.10 Manifold System (cont'd)



Green Disk= Pressure Valve



• TO ESC Control

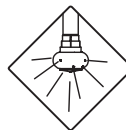

• To Tank Rinse nozzle



• To Chemical Filler



• To Hose reel /spray gun



Black Disk= Suction Valve



• From Flush Tank



• From Main tank



Blue Disk= Agitation Bypass Valve

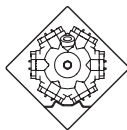

• Return to Pump

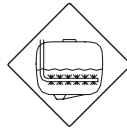

• Return to Tank





## 6.11 Manifold System Operating Instructions

For normal operation of the sprayer the first pressure manifold valve **A** handle is turned toward the ESC control symbol and the suction manifold valve **B** handle is turned toward the main tank symbol. On a standard Manifold system these will be the only symbols fitted on the valves.

When accessories are fitted (i.e. chemical filler, Flush & Rinse™ etc.) operation of these accessories is achieved by turning the relevant valve handle to the required symbol. All the other handles on the same manifold must be turned to the off-position (handle placed horizontal).

Example:

To operate Chemical Filler

1. Ensure other pressure manifold valves are in the **off** position.
2. Turn handle of pressure manifold valve from ESC control symbol to Chemical Filler symbol. This directs flow of liquid from Pump to the Chemical Filler.
3. Operate the Chemical Filler as per pages 16 & 17 in the HARDI-Chemical Filler Operators Manual.
4. Return the pressure manifold valve to it's previous position on completion of use of Chemical Filler.

**Note:** If all the pressure valves are closed, the safety valve will open inside the tank.

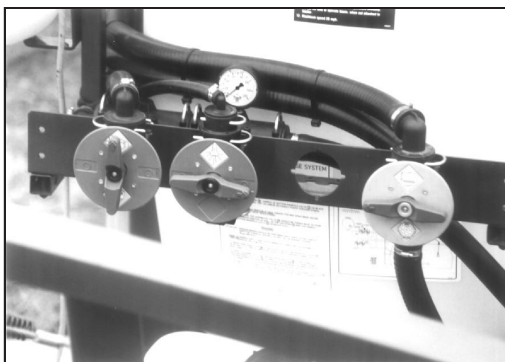

Fig. 24

## 6.12 Agitation Bypass Valve Operation (Optional)

The optional agitation bypass valve is fitted when it is desired to cut the by-pass liquid to the tank at low tank levels and achieve more complete drainage of the tank. The by-passed liquid is directed back to the suction manifold and therefore is recirculated back through the pump.

**This valve, when fitted, must have the handle positioned in either the "Tank" position or the "Pump" position. There is no "Off" position indicated on this valve.**

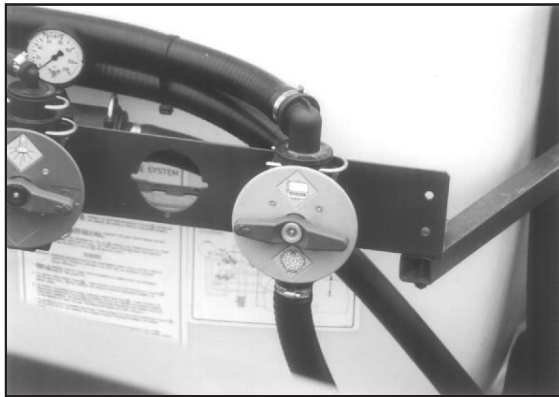

Fig. 25

## 6.13 Operation of the Tank Drain Valve

***WARNING: BEFORE USING THE TOP DRAIN VERIFY THAT DISPOSAL OF WASTE IS DONE ACCORDING TO CHEMICAL LABEL INSTRUCTIONS AND LOCAL REGULATIONS.***

The tank is drained through the suction manifold valves on the lower left hand side of the tank frame.

To drain the tank proceed as follows:

1. Ensure that the handle on the valve under the tank is turned to a horizontal position with the arrow on the handle facing up.(Fig. 26)
2. Ensure that the handle on the suction manifold valve is placed in a vertical position.





### 6.13 Operation of the Tank Drain Valve (cont'd)

3. Remove the stainless steel fork that retains the 90° hose fitting to the bottom of the tee piece on the suction manifold.
4. Remove the 90° hose fitting from the valve. (Fig. 27)
5. Turn the valve handle on the valve under the tank back to a horizontal position.

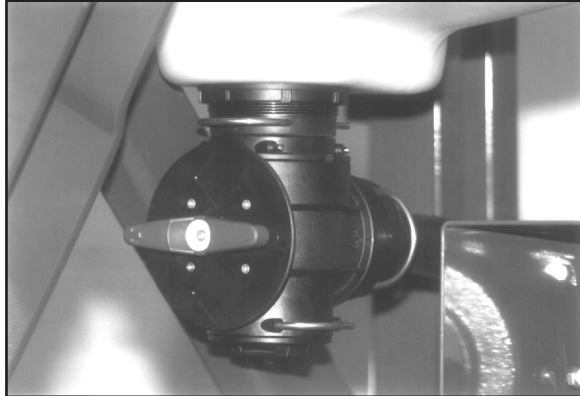

Fig. 26



**WARNING: WEAR PROTECTIVE CLOTHING WHEN SERVICING AND HANDLING COMPONENTS THAT HAVE BEEN IN CONTACT WITH SPRAY LIQUID.**

6. Turn the handle on the suction manifold valve back so that the arrow on the handle is facing the symbol for the main tank.
7. The tank will now drain. Be aware of splashing. If draining residues (eg. liquid fertilizer) into a reservoir, a coupler with hose can rapidly be connected to the suction manifold tee piece and the liquid safely drained.

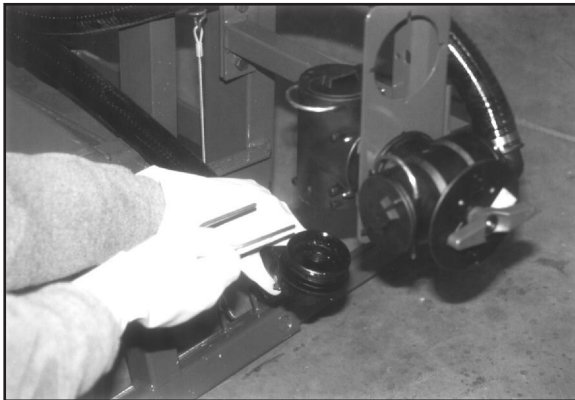

Fig. 27



## 6.14 Nozzle Selection

Correct selection of nozzle and calibration of the sprayer are critical to achieve accurate and cost effective use of farm crop protection products.

Your HARDI sprayer has been supplied with 110° flat spray Green Color Tips™ that will apply approximately 20 U.S. GPA at 30 PSI and 5 MPH. The 110° flat spray nozzle was chosen rather than the 80 degree nozzle for two reasons: 1- It may be used at a lower minimum height which reduces the risk of wind drift; 2- It's greater overlap permits better uniformity of spray distribution, particularly if boom height varies on rough ground. Normal boom height setting with 110° nozzles is 18" to 20" above the crop or weeds, whichever is taller.

Should you wish a different application rate or different type of nozzle, HARDI manufactures a nozzle for virtually every need. Refer to the Hardi Nozzle Catalog for the complete range of Hardi Nozzles.

**ALWAYS CONSULT YOUR CHEMICAL SUPPLIER FOR RECOMMENDED CHEMICAL RATE AND WATER APPLICATION RATE. ALWAYS WEAR PROTECTIVE GLOVES WHEN HANDLING NOZZLES.**



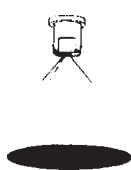

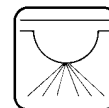
The following tables show what types of spray nozzles are suitable for different applications. Refer to the HARDI nozzle catalogue to find the correct nozzle for each spraying application.

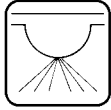
	<p>COLOR TIPS™ 110 degree flat fan, one piece cap and nozzle; color coded for flow rate selection. For herbicides, insecticides, and fertilizer applications. 50, 80, and 100 mesh screens are normally used.</p>	<p>S4110</p>
	<p>FLAT SPRAY NOZZLES in 65 degree, 80 degree, and 110 degree spray angles. For herbicides, insecticides, and fertilizer applications. 50, 80, and 100 mesh screens are normally used.</p>	<p>4665-65 degree 2080-80 degree 4110-110 degree</p>



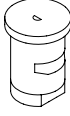

## 6.14 Nozzle Selection (cont'd)

	<p>FLOOD NOZZLES set at 40" spacing. Designed for high volume application.</p>	<p>4598</p>
	<p>HOLLOW CONE NOZZLES for high pressure and high volume insecticide application in row crops. 1553 nozzles are ALWAYS used with swirl plates shown below EXCEPT when used as solid stream nozzles. 50,80, or 100 mesh screens are normally used with these nozzles.</p>	<p>1553 Must add swirl to produce hollow cone pattern</p>
	<p>SWIRL PLATE used in conjunction with cone nozzle to create desired spray pattern. These swirls work with 1553 series cone nozzles. Grey, blue, or black swirls are used to create hollow cone effect. White swirls are used to create full cone effect.</p>	<p>Grey Blue Black White</p>
	<p>HOLLOW CONE CERAMIC NOZZLES for high pressure and high volume fungicide and insecticide application.</p>	<p>1299</p>
	<p>LARGE DROPLET HOLLOW CONE NOZZLE for use where drift must be kept to a minimum. These nozzles must always be fitted with 1553 nozzles and grey swirl plates. 50,80 or 100 mesh screens are normally used with these nozzles.</p>	<p>371077</p>

## 6.14 Nozzle Selection (cont'd)

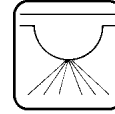

	<p><b>LARGE DROPLET FLAT SPRAY TIP IN 150 DEGREE SPRAY ANGLE.</b> Always used in conjunction with 1553-14-16-18 or 20 cone nozzle. 50,80 or 100 mesh screens are normally used with these nozzles.</p>	<p>371551</p>
	<p><b>SOLID STREAM NOZZLE</b> for high volume liquid fertilizer application. In this application, the 1553 nozzle is always used with 330013 o-ring and 50,80 or 100 mesh screens.</p>	<p>1553 less swirl</p>
	<p><b>3-HOLE NOZZLE-SYNTAL/ CERAMIC</b> this nozzle disperses the spray liquid in three solid streams, thereby reducing the number of plants at risk of scorching by the application of liquid fertilizer.</p>	<p>371537 thru 371543</p>



## 6.15 Calibration

**WARNING: ALWAYS CALIBRATE YOUR SPRAYER WITH CLEAN WATER ONLY! IN ADDITION, WEAR PROTECTIVE CLOTHING WHEN CALIBRATING YOUR SPRAYER!**



### Why must you calibrate a sprayer?

A nozzle selection chart will tell you what application rate you should expect. Variations due to nozzle wear, errors in pressure adjustment, and tractor speedometer can result in a possible error in application rate.

### How do you calibrate a sprayer?

Calibration kits are available from HARDI, #818103 for US gallons & #818104 for metric calibration.

Following are some tips to remember when using the calibration kit method:

- When determining the length of time required to drive the recommended distance, drive in actual field conditions with a half-full tank.
- Repeat the test several times, each time avoiding the tracks from the previous test. Take the average of the times recorded.
- Calibration of the sprayer should be completed at the beginning of the season and repeated after every 2 to 3 full days of spraying, and every time you change volume rate or use new nozzles.
- Before you calibrate, check the flow of each nozzle. If it puts out more than 10% of its original volume, replace it.

## 6.15 Calibration (cont'd)

Select your calibration method- Ounce method or Formula method.

Then follow the steps described below:

### Ounce Method

1. Determine how long it takes you to cover the test strip.  
Use the following chart to determine the length of your test strip.  
Row width for broadcast application is equal to your nozzle spacing.  
For your drop nozzle or band application, use row spacing.

<u>Row width or nozzle spacing (in.)</u>	<u>Distance (ft.)</u>
40	102
38	107
36	113
34	120
32	127
30	136
28	146
26	157
24	170
22	185
20	204
18	227
16	255
14	291

2. Measure the amount of time it takes you to travel the test strip when throttle is set at spraying speed.
3. In a container (with oz. measurements), catch the spray from one nozzle for that amount of time. For drop or band nozzles, catch the spray from all nozzles for the row.
4. Read the ounces in the container. That is the actual GPA applied.  
(ounces - GPA)

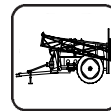

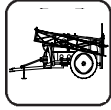

## 6.15 Calibration (cont'd)

### Formula Method

1. Check your spraying speed.

Measure a test strip of at least 200 feet (300 feet is ideal). Travel the distance at the speed you plan on spraying and record the time it takes to travel the distance. Read from the chart or use the formula to find your exact travel speed.

Formula:	Speed in MPH	Travel Time (in seconds)	
		200 ft.	300 ft.
$\frac{\text{distance (ft.)} \times 0.68}{\text{seconds}} = \text{MPH}$	3.0	45	68
	3.5	39	58
	4.0	34	51
	4.5	30	45
	5.0	27	41
	6.0	23	34
	7.0	19	29
	7.5	18	27
	8.0	17	26
	9.0	15	23

2. Calculate the required nozzle output. Use either the nozzle wheel (if nozzle spacing is 20 inches), or this formula:

Formula:

$$\text{GPM} = \frac{\text{GPA} \times \text{MPH} \times \text{W (in.)}}{5940}$$

Formula:

$$\text{GPM} = \frac{10 \times 7 \times 20}{5940} = .24 \text{ GPM}$$

### Note:

- W=
- Nozzle spacing (in inches) for broadcast application.
  - Row spacing (in inches) divided by number of nozzles per row for drop nozzle application.
  - Sprayed band width or swath width (in inches) for band application divided by number of nozzles per band.
  - Note that on the nozzle wheel, W = 20 inches.

3. Set correct pressure.

Read the required pressure from the nozzle table in the nozzle catalogue or nozzle wheel. With clean water in the tank and line, turn on the sprayer and set the target pressure. Collect the spray from one nozzle for one minute in a container. Adjust pressure until you collect the precise GPM called for.

## 6.15 Calibration (cont'd)

### Calibration for carriers other than water

Use the following water rate conversion chart to determine the right conversion factor. When you've determined the new converted GPM or GPA, you can follow the steps on either the pressure or ounce method of calibration.

<u>Weight of solution</u>	<u>Specific Gravity</u>	<u>Conversion Factors</u>
7.00 lbs/gal	.84	.92
8.00 lbs/gal	.96	.98
8.34 lbs/gal-water	1.00	1.00
9.00 lbs/gal	1.08	1.04
10.00 lbs/gal	1.20	1.10
10.65 lbs/gal-28% N	1.28	1.13
11.00 lbs/gal	1.32	1.15
12.00 lbs/gal	1.44	1.20
14.00 lbs/gal	1.68	1.30

Example: 20 GPA of 28% N  
Then GPA (solution) x conversion factor = GPA (water)  
20 GPA (28% N) x 1.13 = 22.6 GPA (water)  
Calibrate for 22.6 GPA of water

For conversion to Imperial gallons per acre, multiply U.S. GPA by .833

For conversion to liters per hectare, multiply U.S. GPA by 9.34

For conversion to liters per acre, multiply U.S. GPA by 3.78

Formula for tractor speed:  $\frac{\text{Distance (in feet)}}{\text{Second}} \times .682 = \text{MPH}$

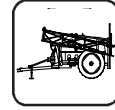



## 7.0 MAINTENANCE

**ALWAYS CLEAN BOOM AT THE END OF YOUR WORKDAY OR BEFORE SERVICING IS DONE TO AVOID UNNECESSARY CONTACT WITH CHEMICALS.**



In order to derive full benefit from the sprayer for many years the following few but important rules should be kept:

### 7.1 Cleaning the Sprayer



#### Guidelines

Read the whole label of the chemical. Take note of any particular instructions regarding recommended protective clothing, deactivating agents, etc. Read the detergent and deactivating agent labels. If cleaning procedures are given, follow them closely.

Be familiar with local legislation regarding disposal of pesticides washings, mandatory decontamination methods, etc. Contact the appropriate body, eg. Dept of Agriculture.

Cleaning starts with the calibration, as a well calibrated sprayer will ensure the minimal amount of remaining spray liquid.

It is good practice to clean the sprayer immediately after use thereby rendering the sprayer safe and ready for the next pesticide application. This also prolongs the life of the components.

It is sometimes necessary to leave spray liquid in the tank for short periods, eg. overnight, or until the weather becomes suitable for spraying again. Unauthorized persons and animals must not have access to the sprayer under these circumstances.

The Hardi Flush & Rinse™ system is available for the Mega sprayer that offers both the flushing of internal components and also a highly effective internal rinsing system of the sprayer tank.

If the product applied is corrosive, it is recommended to coat all metal parts of the sprayer before and after use with a suitable rust inhibitor.

Remember: Clean sprayers are safe sprayers.  
Clean sprayers are ready for action.  
Clean sprayers can not be damaged by pesticides and their solvents.



## Cleaning

1. Dilute remaining spray liquid in the tank with at least 10 parts water and spray the liquid out in the field you have just sprayed.

**NOTE: It is advisable to increase the forward speed (double if possible) and reduce the pressure. For S4110 nozzles, pressure may be reduced to 22psi (1.5 bar).**

2. Select and use the appropriate protective clothing. Select detergent suitable for cleaning and suitable deactivating agents if necessary.
3. Rinse and clean sprayer and tractor externally. Use detergent if necessary.
4. Remove tank and suction filters and clean. Be careful not to damage the mesh. Replace suction filter top. Replace filters when the sprayer is completely clean.
5. With the pump running, rinse the inside of the tank. Remember the tank roof. Rinse and operate all components and any equipment that has been in contact with the chemical.
6. After spraying the liquid out again in the field, stop the pump and fill at least 1/5 of the tank with clean water. Note that some chemicals require the tank to be completely filled. Add appropriate detergent and/or deactivating agent, eg. Washing soda or Triple ammonia.

**NOTE: If a cleaning procedure is given on the chemical label, follow it closely.**

7. Start the pump and operate all controls enabling the liquid to come in contact with all the components. Leave the distribution valves until last. Some detergents and deactivating agents work best if left in the tank for a short period. Check the label.
8. Drain the tank and let pump run dry. Rinse inside of tank, again letting the pump run dry.
9. Stop the pump. If the pesticides used have a tendency to block nozzles and filters, remove and clean them now.
10. Replace all the filters and nozzles and store the sprayer. If, from previous experiences, it is noted that the solvents in the pesticide are particularly aggressive, store the sprayer with the tank lid open.

**NOTE: If the sprayer is cleaned with a high pressure cleaner we recommend lubrication of the entire machine.**





## 7.2 Filters

**WARNING:** *Wear protective clothing when servicing & handling components that have been in contact with spray liquid.*

Clean filters ensure :

- Sprayer components such as valves, diaphragms and operating unit are not hindered or damaged during operation.
- Nozzle blockages do not occur while spraying.
- Long life of pump. A blocked suction filter will result in pump cavitation.

### Suction filter

The optional suction filter is located at the back of the pump, check it regularly. Ensure the o-ring **A** (fig. 17) on the filter housing and it is in good condition and lubricated.

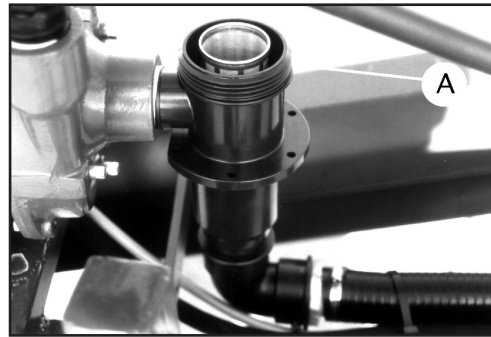

Fig. 28



Nozzle Size	Suction Filter	Pressure Filter	Nozzle Screen
 Lilac (08) Brown (10) Yellow (12) Orange (14)	 50	 100	 100
Red (16) White (18)	50	80	80
Green (20) & Larger	30*	50*	50*

Fig. 29



\* Standard Equipment

### 7.3 Lubrication

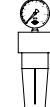
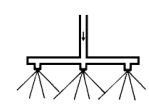
Recommended lubrication is shown in following tables.  
Use ball bearing grease (lithium grease No. 2)

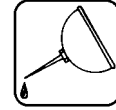
**Note: If the sprayer is cleaned with a high pressure cleaner or fertilizer has been used, we recommend lubrication of all sections.**



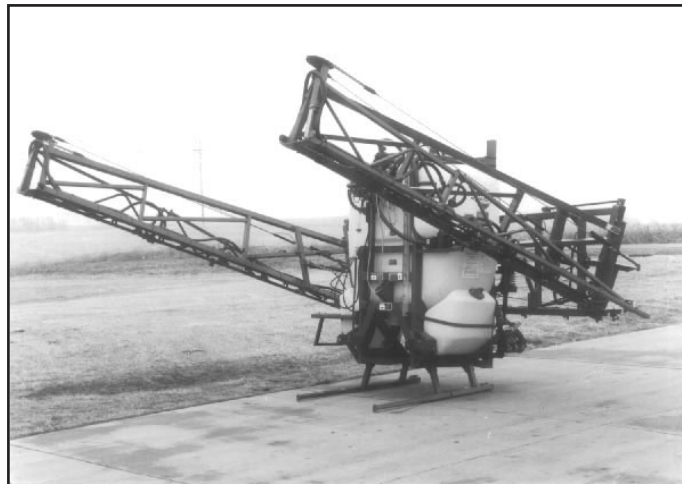

<b>POS.</b>	Position on sprayer		Grease
	Oil		Operation hours



*Fig. 30  
Mega 350*

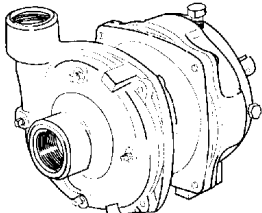
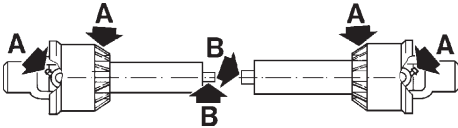

POS.				
		X	1000	
A		X	8	
B		X	40	

#### 7.4 Greasing the H-Frame and Center Frame

Every 8 hours new grease should be applied to the wear surfaces on the H-frame and center frame.

Every 50 hours the grease on the H-frame and center frame should be completely cleaned off with a degreasing solvent and new grease applied.

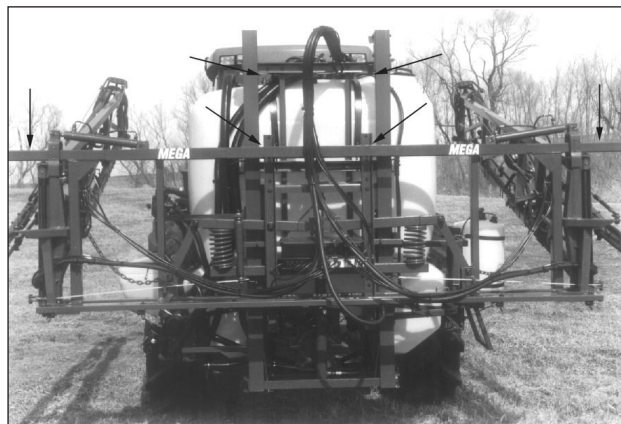
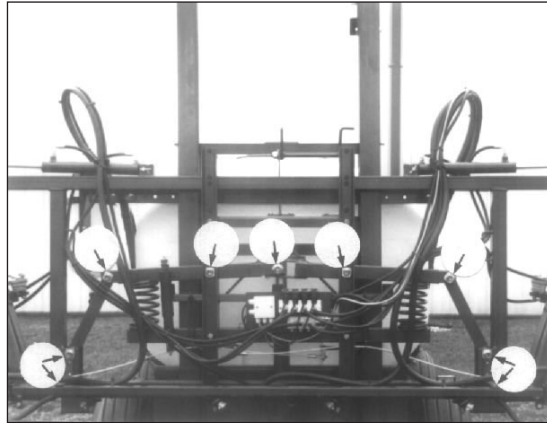

Fig. 31

## 7.5 Greasing the Boom

Every 10 hours the grease zerts indicated in the following pictures should be greased.



*Fig. 32*

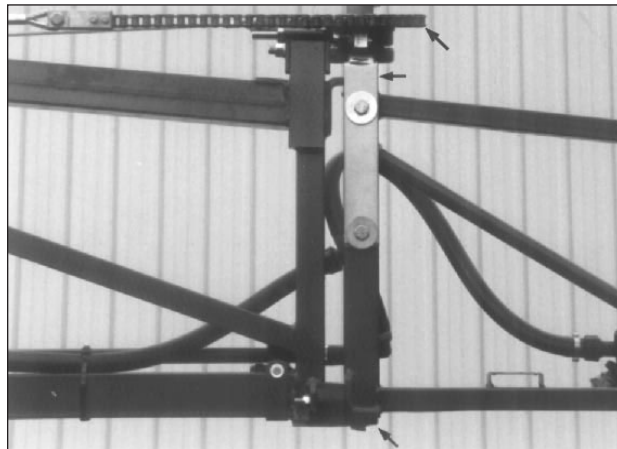

*Fig. 33*



## 7.6 Lubrication of Chain and Sprocket

Every 25 hours the chain and sprocket at the hinge point of the intermediate and outer wing sections should be lubricated with a chain lubricant.



## 7.7 Greasing the Breakaway Clutch

**NEVER PLACE FINGERS INTO OPEN BREAKAWAY CLUTCH OR YOU MAY BE INJURED SHOULD CLUTCH SNAP CLOSED.**

1. Unfold the boom into spray position.
2. Standing in front of the outer wing, snap the breakaway open by quickly pushing the boom away from you.
3. With the two clutches opened up, stick the nozzle of grease gun into the clutch and apply a generous amount of grease. This should be done every 8 hours. (Refer to fig. 34)
4. Apply oil to top of breakaway section hinge to lubricate bushing.

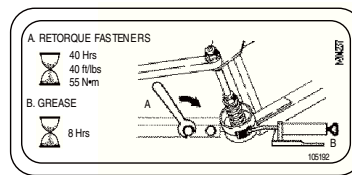

Fig. 34

## 7.8 Maintenance of Triplets (When Fitted)

Every 40 hours the triplets should be disassembled removed and cleaned. This is done by pulling out the stainless clip on the side of the triplet assembly.

Clean the bottom part as well as the top part thoroughly.

Coat o-ring surface with a light film of vegetable oil, if unit is to be stored for a long period of time.

If the triplets are not cleaned regularly they may become hard to turn, with possible damage to them as a result.

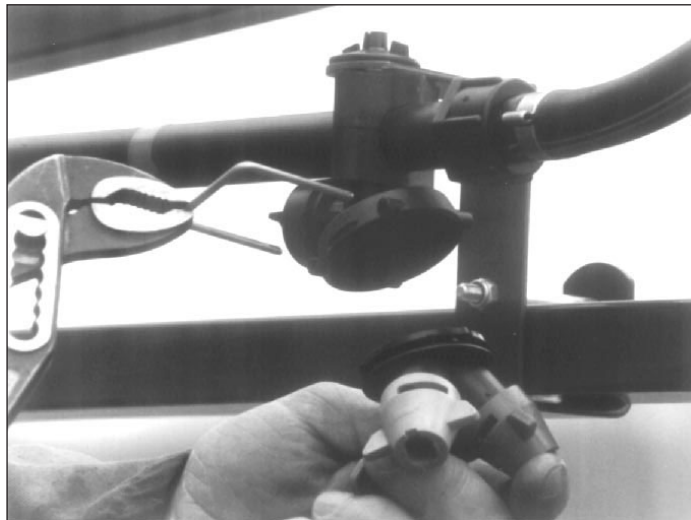

*Fig. 35*

**WARNING: NEVER SERVICE YOUR CONTAMINATED NOZZLES WITHOUT WEARING CHEMICAL RESISTANT GLOVES AND SAFETY GOGGLES.**





## 8.0 ADJUSTMENTS

**HARDI CANNOT ASSUME RESPONSIBILITY OR BE HELD LIABLE FOR ANY LOSS OR DAMAGE THAT OCCURS DUE TO LACK OF ADJUSTMENTS OR MAINTENANCE.**

**WE URGE YOU TO FOLLOW THE ADJUSTMENT AND MAINTENANCE RECOMMENDATIONS FOR EVERYONES SAFETY.**

**MAKE IT A DAILY HABIT TO INSPECT YOUR BOOM FOR NEED OF ADJUSTMENT OR MAINTENANCE.**

**IMMEDIATELY REPLACE ANY PARTS ON THE BOOM THAT ARE WORN OR BROKEN.**

**ALWAYS CLEAN YOUR BOOM BEFORE ADJUSTING IT TO AVOID UNNECESSARY CONTACT WITH CHEMICALS.**

The boom wing sections on the Mega Sprayer have been preassembled, adjusted and tested in the factory. The boom however, will require additional adjustments shortly after being taken into use (10 hours) and thereafter at a minimum an annual basis to perform at its maximum levels.

To further insure the booms proper performance, the Mega boom also has to be maintained on a regular basis. Please follow the suggested maintenance intervals.

Perform the adjustment procedures in the same sequence as they are written in this manual.

### 8.1 Adjustment and Maintenance Intervals

**IMPORTANT:** To maximize boom life and performance, retighten all boom fasteners and inspect boom for proper adjustment after the first 10 hours of use.

Lubricating of the boom should be done daily to ensure maximum performance and life.(Refer to maintenance section 7)



## 8.2 Checking and Adjusting Sprocket Timing

1. With boom unfolded in the working position, check to ensure that the seventh pin connection (A) in the timing chain is aligned with the center line between the sprocket cap screws (B).
2. To adjust timing, loosen turnbuckles on the front and rear cables until slack.
3. Standing on the front side of the boom, position the seventh pin (A) of the timing chain on the sprocket as indicated in step 1.
4. Adjust front and rear cable tension. (Refer to sections 8.5 & 8.10)

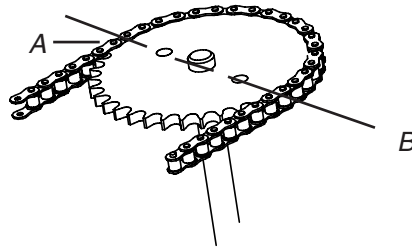

Fig. 36

## 8.3 Aligning Wing Assemblies

(Fig. 37)

1. With boom unfolded and in the working position, check alignment of the intermediate section with the center frame.
2. With fold cylinder pressurized, determine if the intermediate section needs to be adjusted to the front or rear to come into alignment with center frame.

**NOTE:** Because of adjustments made later, it is better to start with the wing assemblies angled slightly to the rear.

3. Relieve pressure from cylinder by folding boom in a few inches.

**NOTE:** Cylinder rods have a machined flat which, if visible, can be used for adjustments. If using machined flat for adjustment, leave rod eye pinned to boom and loosen jam nut





### 8.3 Aligning Wing Assemblies (cont'd)

4. Disconnect cylinder rod eye (B) from the intermediate boom section.
5. Loosen jam nut (A) and adjust rod eye (B) IN to move boom forward or OUT to move boom rearward. Tighten jam nut (A).
6. Reattach cylinder rod to boom and pressurize cylinder to check boom alignment.

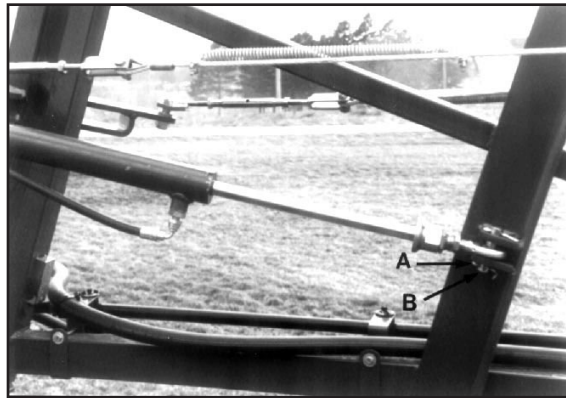

*Fig. 37*

### 8.4 Aligning Intermediate and Outer Boom Sections

1. Unfold boom into operating (spraying) position.
2. Hold M12x100 adjusting bolt, loosen lock nut, and turn nut so cap screw head contacts top stop with outer and intermediate boom sections aligned.
3. Check to ensure that lock nut is tight.

## 8.5 Adjusting Front Fold Cables (Fig. 38)

**CAUTION: REAR CABLE CAN SNAP AND INJURE YOU OR SOMEONE ELSE IF TENSIONED WHEN THE BOOM IS UNFOLDED. ALWAYS ADJUST FRONT CABLE FIRST WITH THE BOOM UNFOLDED AND REAR CABLE LAST WITH THE BOOM FOLDED IN TRANSPORT POSITION.**

1. Unfold boom into operating (spraying) position.
2. Shut the tractor off.
3. Slide a straight edge down the underside of intermediate boom section until it just contacts the front cable.
4. Suspend a 10lb (4.5kg) weight from the straight edge-to-cable contact point and check deflection by measuring the distance from the straight edge to the cable. Cable should deflect .50-.75in.(13-20 mm).
5. Loosen jam nuts (A) on the turnbuckle assembly and adjust turnbuckle (B) for proper cable deflection. (Fig. 38).
6. Tighten jam nuts (A) and remove weight.

**IMPORTANT: Check boom alignment again. If front cable was tightened, the wing assembly will move forward; or if loosened, wing will move rearward. Adjust fold cylinder (if necessary) as described in Aligning Wing Assemblies.**

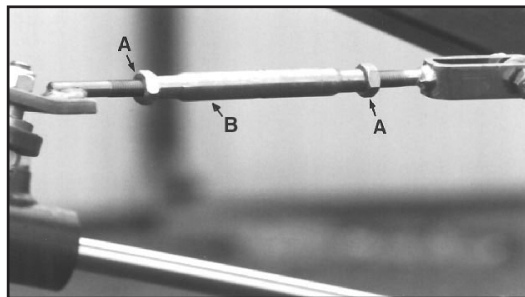

Fig. 38





## 8.6 Adjusting Breakaway Clutch Tension (Fig. 39)



**CAUTION!** *Never place fingers into open breakaway clutch or you may injured should clutch snap closed.*

**NOTE:** Spring pressure from tensioned breakaway clutch assists in returning outer boom section to alignment.

1. Loosen jam nut **C**.
2. Tighten nut **D** to stiffen clutch action. Clutch is properly tensioned when breakaway boom section returns to alignment with outer boom section after breaking away. Tighten jam nuts after adjustment.

**IMPORTANT:** *Properly lubricate clutch assembly before adjusting the tension.*

**Breakaway clutch cap screws (A) must be torqued to 55 N-m (40lb-ft) every week (40 hours) to prevent boom damage. Lubricate every day (8 hours) to ensure maximum performance and life.**

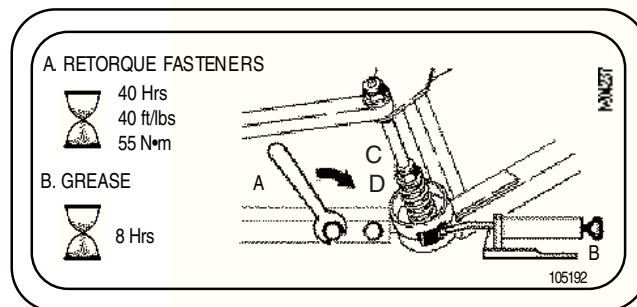
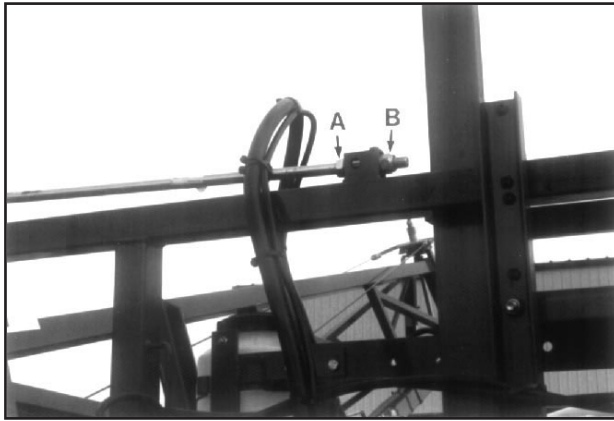

Fig. 39

## 8.7 Adjusting Boom Wing To Be Level To Ground

### HY-BOOMS



*Fig. 40*

1. Loosen jam nut **A**
2. Adjust nut **B** in or out until wing is level to ground.
3. Secure jam nut **A**

Same procedure applies to both sides.



## 8.7 Adjusting Boom Wing To Be Level To Ground (cont'd)

### HZ-BOOMS



*Fig. 41*

1. Loosen jam nut **A**.
2. Apply an adjustable wrench to the machined surface at **B**.
3. Turn the cylinder rod until boom is level to the ground.
4. Secure jam nut **A**.

Same procedure applies to both sides.

## 8.8 Adjusting Floating Frame Pivot

*NOTE: Lubricate pivot linkage (7 places) and grease skid plates prior to adjustment.*

1. Park machine on level surface.
2. Manually lift one outer boom end approximately 20 in. (490mm) above horizontal.
3. Release boom end. Boom should smoothly return to horizontal or near horizontal position.
4. If boom does not return to horizontal, loosen each adjustment cap screw **A** 1/2 turn and check again. (Fig. 42 )

If boom pivots too freely, tighten adjustment cap screws 1/2 turn and check again.

Boom is properly adjusted when it returns to horizontal position.

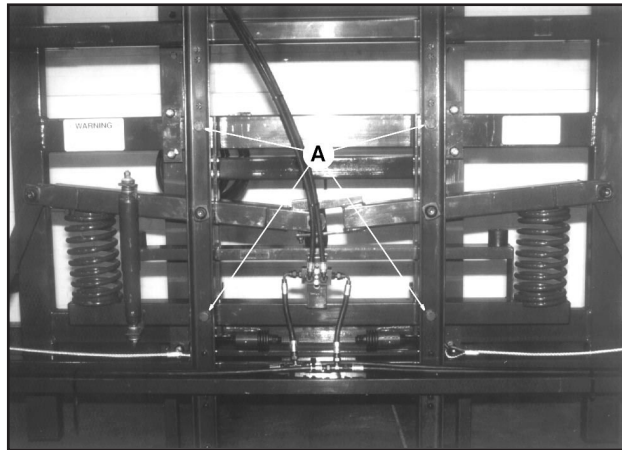

*Fig. 42*



## 8.9 Adjusting Boom Transport Position

1. Fold boom into transport position. With fold cylinder pressurized, determine if boom sections need to be adjusted inwards or outwards. **Ensure boom wings will not interfere with tractor wheels or structure.**
2. Relieve pressure from cylinder by unfolding boom a few inches.
3. Loosen jam nut **A** and adjust collar **B** IN to move boom out away from cab or OUT to move boom in toward cab. (See fig. 43)
4. Secure jam nut **A**.
5. Pressurize cylinder to see if boom is properly adjusted. If not repeat the above procedure until it is correctly adjusted.

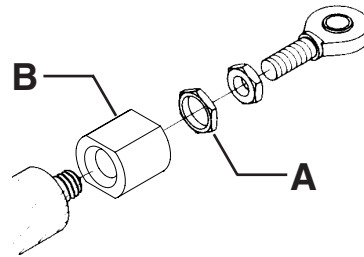

Fig. 43

## 8.10 Adjusting Rear Cable



**CAUTION: REAR CABLE CAN SNAP AND INJURE YOU OR SOME ONE ELSE IF TENSIONED WHEN THE BOOM IS UNFOLDED. ALWAYS ADJUST FRONT CABLE FIRST WITH THE BOOM UNFOLDED INTO SPRAYING POSITION. (SECTION 8.5)**

1. Raise boom to its highest position. Fold boom to transport position with tilt cylinders fully extended. Make sure fold cylinders are pressurized and that boom is folded all the way in.
2. Shut the tractor off.
3. Loosen the jam nuts on the turnbuckle. Adjust (tighten) the turnbuckle so that the outer wing section contacts the boom transport stop bracket. Tighten the turnbuckle another three complete turns and retighten the jam nuts.



## 9.0 WINTER STORAGE

When the spraying season is over you should devote some extra time to the sprayer before it is stored.



### Hoses

Check that none of the hoses are caught or have sharp bends. A leaky hose can give an annoying delay in the middle of the spraying job. Therefore check all the hoses and change if there is any doubt about the durability.

### Paint

Some chemicals are very hard on paints. It is therefore recommended to remove rust, if any, and then touch up the paint.

### Tank

Check that no chemical residues are left from the last spray job. Chemical residues must not be left in the tank for a long time. This will reduce the life of the tank. See section on cleaning the sprayer.

### ESC Controls

When storing the sprayer, the control box and the multiplug must be protected against moisture and dirt. A plastic bag can be used around the plug.

### P.T.O. shaft

It is important that the push pins are clean and well lubricated, to ensure safe function. Every 40 hours: Inspection of protection guards, function and condition. Replace possible damaged parts. Every 1000 hours: Check condition of protection guards and replace nylon bearings. Check general condition of cross journals and push-pin/quick release - replace if necessary.

### Anti-freeze precaution

If the sprayer is not stored in a frost free place you should take the following precautions: Drain as much water as possible from sprayer. Pour in a mixture of ethylene glycol base anti-freeze and water at the ratio for the desired temperature protection. (Volume of mixture should be about 1% of tank volume) Run the sprayer and circulate the anti-freeze in to the pump, controls and boom lines.

### NOTE: NEVER USE OIL OR DIESEL FUEL IN A SPRAYER

The anti-freeze solution also prevents the O-rings and gaskets from drying out. Remove the glycerine filled pressure gauge and store it in a frost free and vertical position. Remove nozzles & screens. Clean and store in a safe, dry location. Turn pressure regulator valve counter-clockwise until all spring tension is released. Turn boom section valves off. Store sprayer in a safe, dry location away from children and animals. Protect from direct sunlight.



## 10.0 OPERATIONAL PROBLEMS

In cases where breakdowns have occurred the same factors always seem to come into play:

- Minor leaks on the suction side of the pump will reduce the pump capacity or stop the suction completely.
- A clogged suction filter will hinder or prevent suction so that the pump does not operate satisfactorily.
- Clogged up pressure filters will result in increasing pressure at the pressure gauge but lower pressure at the nozzles.
- Poorly reassembled pumps, and pump fittings, will allow the pump to suck air resulting in reduced or no pumping capacity.
- Electrical and hydraulic components that are contaminated will result in poor connections and rapid wear to the hydraulic system.

### Therefore ALWAYS check:

1. Suction, pressure and nozzle filters are clean.
2. Hoses for leaks and cracks, paying particular attention to suction hoses.
3. Gaskets and O-rings are present and in good condition.
4. Pressure gauge is in good working order. Correct dosage depends on it.
5. Operating unit functions properly. Use clean water to check.
6. Electrical and hydraulic components are maintained clean.

## 10.1 Nozzle Tubes and Fittings

Poor seals are usually caused by;

- Missing O-rings or gaskets
- Damaged or incorrectly seated O-rings
- Dry or deformed O-rings or gaskets
- Foreign materials

In case of leaks; **DO NOT** overtighten any fittings.(Fig. 44). Disassemble, check the condition and position of any O-ring or gasket, clean, lubricate and then reassemble.

For **radial** connections (Fig. 44) only hand tighten them.

## 10.1 Nozzle Tubes and Fittings (cont'd)

The O-rings need to be lubricated **ALL THE WAY AROUND** before fitting on to the nozzle tube.

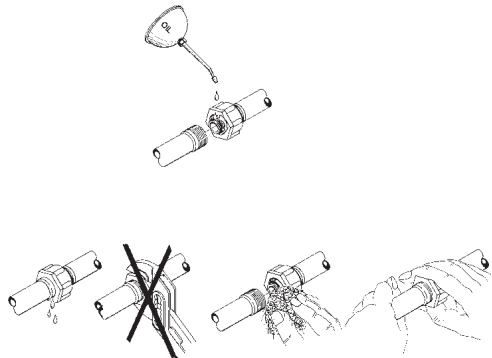

Fig. 44

HARDI recommends using a vegetable based oil to prolong the life of the O-ring.

## 10.2 Checking the Valve Cone in Distribution Valves

Periodically check the distribution valves for proper sealing.

Flush the sprayer with clean water and open master on/off and all distribution valves. (Shut sprayer off)

Remove clip **A** (Fig. 46) and remove hose **B** for the constant pressure device. When the housing is drained make sure everything is clear from part **B** then start sprayer, there should not be any flow of liquid through the constant pressure passage. If there is any leakage, the valve cone **E** must be changed. (Shut sprayer off.)

Remove clip **C**, and pull the EC-motor off the valve housing. Then remove **D** screw and replace the valve cone **E**. Reassemble in opposite sequence.

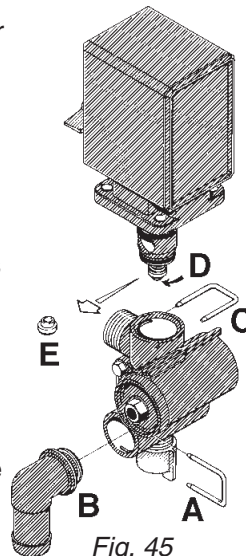

Fig. 45





### 10.3 Emergency Operation of ESC Control

In case of power failure it is possible to operate all functions of the operating unit manually. First disconnect the multiplug from the control box. Now manually turn the emergency control knobs.

The problem may be due to a blown fuse. The fuses are placed in the control box and are marked according to functions. Fuses 7 and 8 are spare fuses.

Fuse type T 500 mA HARDI ref. no. 261125

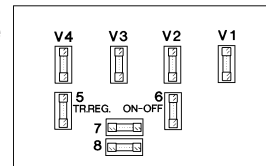
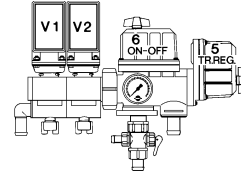

Fig. 46

### 10.4 Level indicator

The level indicator should be checked regularly. When the tank is empty, the floater should rest on the stop pin on the rod and the O-ring at the indicator should be positioned at the top position line **A**.

If any deviation is found, pull out the plug **B**, loosen the screws **C** and adjust the length of the cord.

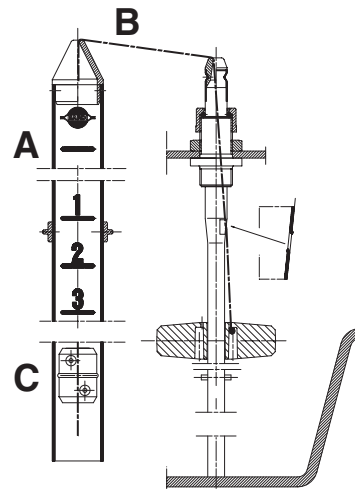

Fig. 47

## 11.0 TROUBLESHOOTING

### 11.1 General Spray Systems



<b>Problem</b>	<b>Cause</b>
1. No liquid getting to the pump.	A. Bottom of Suction Tube plugged. B. Valve on Suction Manifold not in correct position. C. Suction filter O-ring air leak.
2. Lack of pressure.	A. Bottom of suction tube plugged. B. Motor shaft coupling loose or fork pin missing. C. Bad seat on spool valve for boom section control. D. PTO speed not fast enough. E. Valve on Suction Manifold not in correct position. F. Bad suction valve or suction side air leak. G. PTO not engaged. H. Valves on Pressure Manifold not in correct position. I. Agitation nozzles worn or missing.
3. Pressure jumping.	A. Output from by-pass lines causing a disturbance around suction hose. B. Small tear or pin hole in suction hose. C. PTO shaft slipping on pump shaft. D. Bad suction valve or suction side air leak. E. Valves on Pressure Manifold not in correct position.



## 11.1 General Spray Systems (cont'd)

<b>Problem</b>	<b>Cause</b>
4. Pressure dropping.	<ul style="list-style-type: none"><li>A. Output from By-pass Lines causing a disturbance around suction tube inside tank.</li><li>B. Suction filter plugging.</li><li>C. Bad seat on spool valve for boom section control.</li><li>D. Suction Manifold valve or suction side air leak.</li><li>E. Nozzles worn.</li></ul>
5. Liquid leaking from pump.	<ul style="list-style-type: none"><li>A. Damaged pump seal.</li></ul>
6. Electric control not functioning.	<ul style="list-style-type: none"><li>A. Fuse blown.</li><li>B. Motor bad or micro-switch plate loose.</li><li>C. Bad seat on spool valve.</li><li>D. Bad switch or plug on control box.</li><li>E. Print board at back of control corroded or damaged.</li><li>F. Check polarity (Brown: Positive) (Blue: Negative)</li></ul>
7. Less spray out of one boom section than others.	<ul style="list-style-type: none"><li>A. Bad seat on spool valve for Boom Section Control.</li></ul>
8. Poor agitation.	<ul style="list-style-type: none"><li>A. Agitation valve not open.</li><li>B. Agitation nozzle plugged.</li><li>C. Agitation nozzle missing.</li></ul>
9. Excessive vibrations in hoses.	<ul style="list-style-type: none"><li>A. Bottom of suction tube plugged.</li><li>B. PTO shaft slipping on pump crank shaft.</li><li>C. Bad Suction Mainfold valve or suction side air leak.</li><li>D. Valves on Pressure Manifold not in correct position.</li></ul>

## General Spray Systems (cont'd)

Problem	Cause
10. Can't get tank empty.	A. Output from by-pass lines causing a disturbance around suction tube. B. Crack or pin hole in suction tube. C. Tank is not level.
11. Boom nozzle leaking.	A. Seat on master shut-off valve worn or cracked. B. Bad seat on spool valve.



### 11.2 Foam Marker

Problem	Cause
1. Compressor will not run.	A. Short in electrical system or bad compressor. B. 12 volt supply not connected. C. Bad printboard. D. Defective switch in control box.
2. Compressor runs but will not make foam.	A. Bad Printboard B. Not enough Foam Concentrate C. Solenoid valve plugged. D. Solenoid not working
3. Will not make enough foam.	A. Line leak or line pinched B. Solenoid valve plugged C. Weak Foam Concentrate mixture. D. Water too hard (add water softener).
4. Foam drops will not last.	A. Not enough foam concentrate. B. Frequency valve not opened enough. C. Weak Foam Concentrate. D. Water too hard (Add water softener)
5. Keeps blowing fuses.	A. Short in electrical system or bad compressor. B. Bad relay on printboard. C. Tank filter plugged.



### 11.3 Flush & Rinse™

#### Problem

#### Cause

- |  |  |
|--|--|
| 1. System will not flush (pump, control, and boom) | A. Suction Manifold valve not in correct position.<br>B. PTO not engaged.  |
| 2. System will flush but not rinse                 | A. Pressure Manifold valve not in correct position. Arrow on handle should point towards rinse nozzle symbol.  |
| 3. Rinse nozzle has poor output.                   | A. Bad Suction Manifold valve or suction side air leak.<br>B. Pressure Manifold valve not in correct position.<br>C. Chemical filler Pressure Manifold valve in correct position. (if so equipped) |

### 11.4 Chemical Filler

#### Problem

#### Cause

- |   |  |
|---|--|
| 1. Filler tank will not empty.                                  | A. Pressure Manifold valve not in correct position.<br>B. Sprayer pump not running.  |
| 2. Filler tank empties too slow.                                | A. Bottom tank discharge valve not open all the way.<br>B. Restrictor cone from pump supply not the correct size.<br>White-9016/9018 Pump                                |
| 3. Filler tank backfills when bottom tank discharge valve open. | A. Restrictor cone from pump supply line not the correct size (White - 9016/9018 Pump).<br>B. Restrictor cone missing.<br>C. Restrictor cone on wrong side of the valve. |



## 11.5 Hydraulics

### HY/HZ-Model Won't Fold

#### **PROBLEM**

Hydraulic lines not hooked-up properly

Dirt in the restrictors on the cylinders

#### **SOLUTION**

Check the lines for proper hook-up

Remove restrictors and clean them

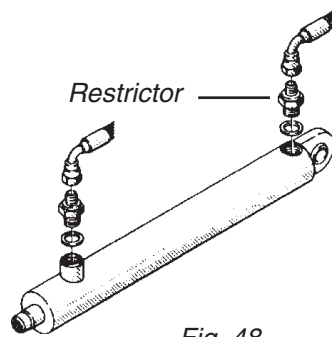

Fig. 48

### HZ-Model Won't Fold

#### **PROBLEM**

Hydraulic lines not hooked-up properly

Switches for hydraulic functions not turned on

Cable from sprayer not attached to control box

No power supply to control box

Cable from control box to hydraulic manifold is damaged

#### **SOLUTION**

Check the lines for proper hook-up

Turn the proper switches on

Attach cable to control box

Check all connections and cables in power supply

Replace cable



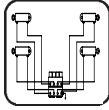

## BOOM WINGS

### PROBLEM

Boom won't fold completely in or out

Boom won't stay in spray position

Boom folds when activating tilt or vice versa.

Wing to be kept folded swings out, when unfolding other side.

Breakaway won't hold outer wing stable

Boom won't go up or down

### SOLUTION

Adjust the fold cylinder

Shut switches off after unfolding boom

Shut switches not used off (HZ-models only)

Boom must be completely unfolded, then fold the desired wing in

Adjust breakaway, replace clutches if worn

H-frame needs to be greased

Grease on H-frame is dry and dirty, needing to be replaced

Center is too tight to H-frame. Readjust center to H-frame

### 11.6 HY-Schematic

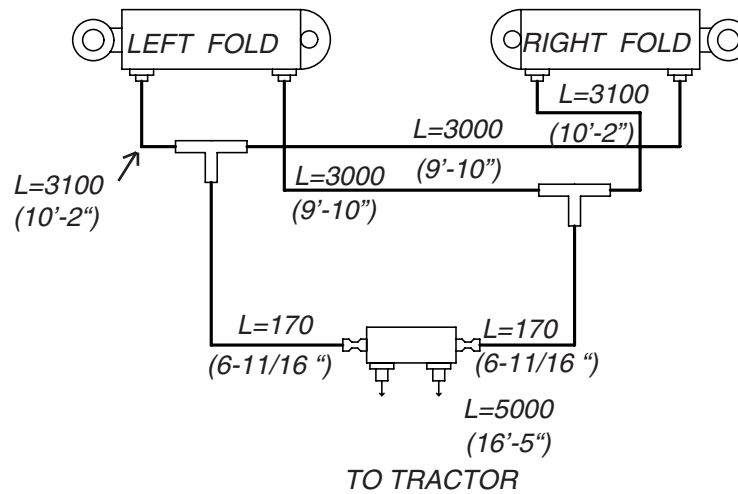

Fig. 49

## 11.7 HZ-Schematic

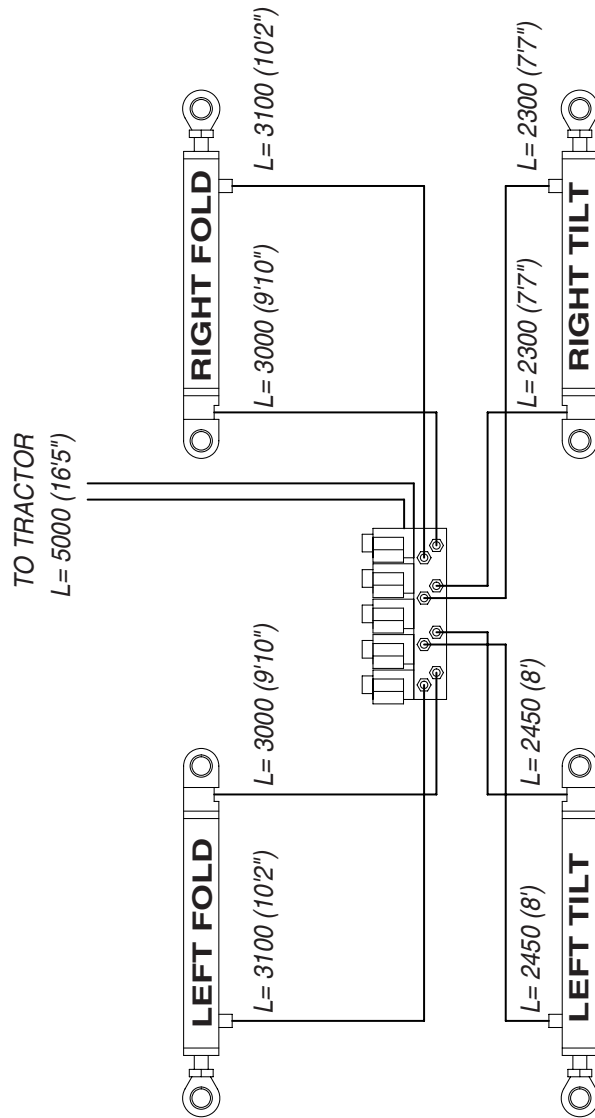
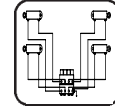

Fig. 50





## 12.0 ACCESSORIES

### 12.1 Chemical Filler

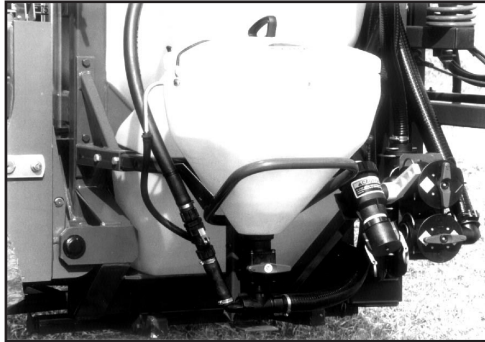

*Fig. 51  
Chemical Filler Installed*

Will inject all types of chemical formulations, liquid, powder or granules, into the bottom of the tank near the agitation flow. A cleaning ring ensures that chemical residue is removed from the tank.

### 12.2 Chemical Filler Rinse Kit



*Fig. 52  
Chemical-Filler Rinse Kit*

A container rinse kit for liquid containers or plastic bags is also available for installation into the chemical filler hopper. Refer to the Chemical Filler Operators Manual for instructions.

## 12.3 Flush System

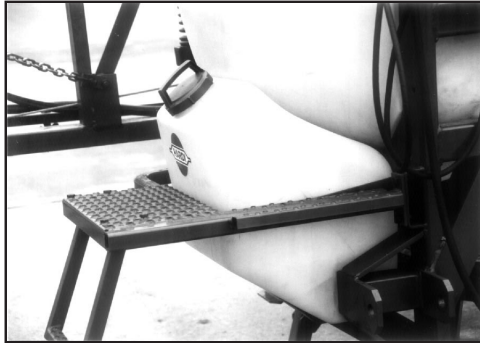

*Fig. 53*  
*Flush & Rinse Tank 1 (22 GAL.)*

Flush system provides a means to be able to flush the pump, controls, boom feed lines and complete boom and nozzles with clean water from an 80 gal. tank. Refer to the Flush & Rinse System™ Operators Manual for complete operational instructions.

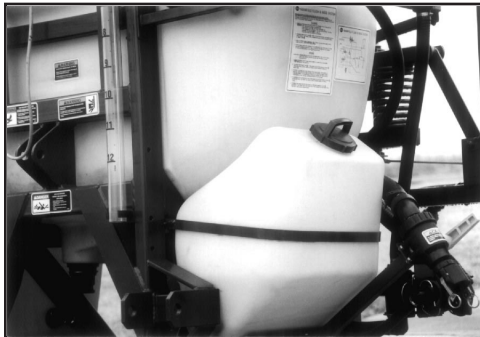

*Fig. 54*  
*Flush & Rinse Tank 2 (22 GAL.)*



## 12.4 Tank Rinse System

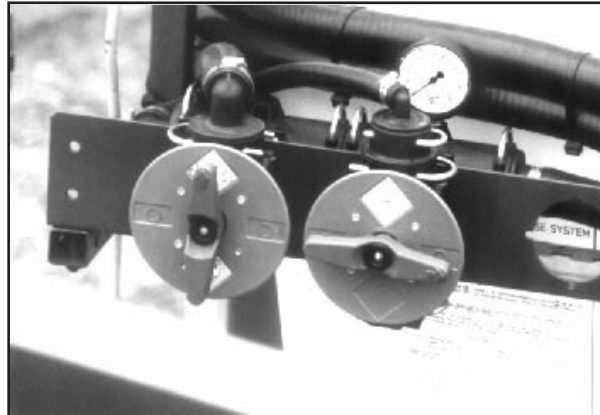

*Fig. 55*  
*Rinse Valve & Gauge*



*Fig. 56*  
*Rinse Nozzle on Top of Tank*

The Rinse system can be added to the flush system which provides a means to rinse the main tank using pressurized water to spray the inside of the tank through specially designed spinning nozzles. See the Flush & Rinse™ System Operator Manual for complete operational instructions.

## 12.5 Foam Marker System



*Fig. 57  
Foam Marker Tank & Compressor*



*Fig. 58  
Foam Marker Drop Assembly*

The Foam Marker helps prevent skipping or over lapping during spray application of solution, both which can be costly. HARDI Foam Marker features a sprayer mounted compressor, poly tank, extruded foamer hoses and in-cab electrical controls providing right or left drop selection and the rate of foam droplets.



## 12.6 Nurse Tank Quick Fill



*Fig. 59*  
*Nurse Tank Quick Fill*

A quick attach hook-up for filling the sprayer tank from a nurse tank. Liquid is fed into the top of the tank through a one-way valve providing a better mix of water and chemical. The quick fill is equipped with a handy 1/4 turn shut-off valve.

## 12.7 Front Tank

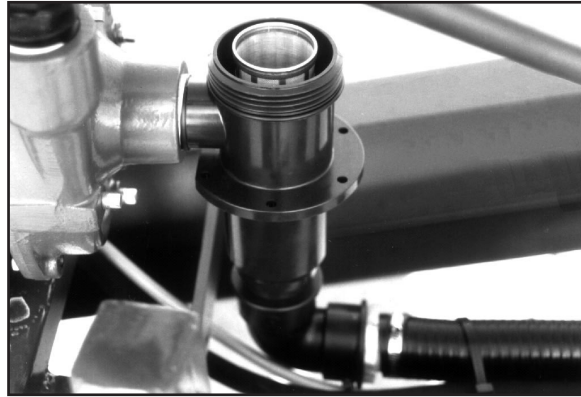

*Fig. 60*  
*Front Tank*

A front tank is available in either 250 or 350 gallon sizes with a full range of options and accessories.



## 12.8 Suction Filter



*Fig. 61*  
*Suction Filter*

The suction filter screens out impurities from the spray solution. It is easily maintained and a variety of screens are available.

## 12.9 Agitation Shut-Off Valve

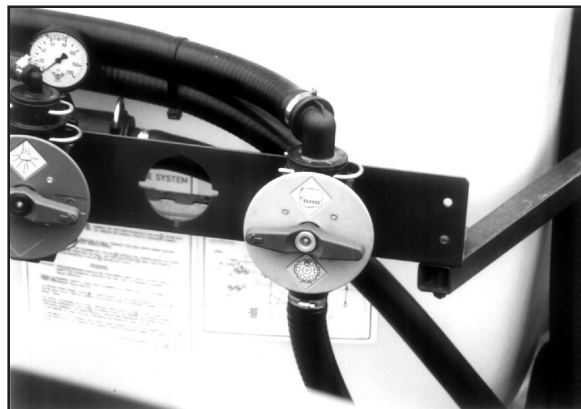

*Fig. 62*  
*Agitation Bypass Valve*

This valve directs either return liquid from the E.C. control to the tank or back to the pump allowing for more complete draining of the tank before cleaning.



## 13.0 WARRANTY POLICY AND CONDITIONS

HARDI INC. , 1500 West 76th Street, Davenport, Iowa USA and 290 Sovereign Road, London, Ontario, Canada hereinafter called "HARDI", offers the following limited warranty in accordance with the provisions below to each original retail purchaser of HARDI new equipment of its own manufacturer, from an authorized HARDI dealer, that such equipment is at the time of delivery to such purchaser, free from defects in material and workmanship and that such equipment will be warranted for a period of one year from the date of delivery to the end user providing the machine is used and serviced in accordance with the recommendations in the Operators Manual and is operated under normal farm conditions.

1. This limited warranty is subject to the following exceptions:
  - a) Parts of the machine are not manufactured by HARDI, (i.e. engines, tires, tubes, electronic controls, and other components or trade accessories, etc.) are not covered by this warranty but are subject to the warranty of the original manufacturer. Any claim falling into this category will be taken up with the manufacturer concerned.
  - b) This warranty will be withdrawn if any equipment has been used for purposes other than for which it was intended or if it has been misused, neglected, or damaged by accident, let out on hire or furnished by a rental agency. Nor can claims be accepted if parts other than those manufactured by HARDI have been incorporated in any of our equipment. Further, HARDI shall not be responsible for damage in transit or handling by any common carrier and under no circumstances within or without the warranty period will HARDI be liable for damages of loss of use, or damages resulting from delay or any consequential damage.
2. We cannot be held responsible for loss of livestock, loss of crops, loss because of delays in harvesting or any expense or loss incurred for labor, supplies, substitute machinery, rental for any other reason, or for injuries either to the owner or to a third party, nor can we be called upon to be responsible for labor charges, other than originally agreed, incurred in the removal or replacement of components.
3. The customer will be responsible for and bear the costs of:
  - a) Normal maintenance such as greasing, maintenance of oil levels, minor adjustments, etc.
  - b) Transportation of any HARDI product to and from where the warranty work is performed.
  - c) Dealer travel time to and from the machine or to deliver and return the machine from the service workshop for repair.
  - d) Dealer traveling costs.
4. Parts defined as normal wearing items, (i.e. tires and V-belts) are not in any way covered under this warranty.
5. This warranty will not apply to any product which is altered or modified without the express written permission of HARDI and/or repaired by anyone other than an Authorized Service Dealer.
6. Warranty is dependent upon the strict observance by the purchaser of the following provisions:
  - a) That this warranty may not be assigned or transferred to anyone.
  - b) That the Warranty Registration Certificate has been correctly completed by dealer and purchaser with their names and addresses, dated, signed and returned to the appropriate address as given on the Warranty Registration Certificate.

## 13.0 Warranty Policy and Conditions (continued)



- c) That all safety instructions in the operators manual shall be followed and all safety guards regularly inspected and replaced where necessary.
7. No warranty is given on second-hand products and none is to be implied.
  8. Subject to the following terms, conditions and contributions, HARDI extends the warranty on polyethylene tanks (excluding fittings, lids and gaskets) to FIVE YEARS. To qualify for this extended warranty, the tank must be drained and flushed with fresh water after each day of use. HARDI's liability is limited to replacement of the tank, FOB our plant at no cost to the purchaser during the first twelve months; at 20% of the then current price during the second year ; at 40% during the third year ; at 60% during the fourth year ; and at 80% during the fifth year. This five year extended warranty is subject, in each instance, to the tank being inspected and approved for replacement or repair by HARDI personnel before HARDI will accept any liability hereunder.
  9. Subject to the following terms, conditions, contributions, HARDI extends the warranty on HARDI diaphragm pumps (excluding wearing parts such as diaphragms, valves, etc.) to FIVE YEARS. To qualify for this extended warranty, the pump must be drained and flushed with fresh water after each day of use. HARDI's liability is limited to replacement of defective parts, FOB our plant in London, Ontario, Canada at no cost to the purchaser during the first twelve months after date of purchase, at 20% of the then current retail price during the second year ; at 40% during the third year ; at 60% during the fourth year ; and at 80% during the fifth year. This five year extended warranty is subject, in each instance, to the tank being inspected and approved for replacement or repair by HARDI personnel before HARDI will accept any liability hereunder.
  10. HARDI reserves the right to incorporate any change in design in its products without obligation and to make such changes on units previously manufactured.
  11. The judgement of HARDI in all cases of claims under this warranty shall be final and conclusive and the purchaser agrees to accept its decisions on all questions as to defect and to the exchange of any part or parts.
  12. No employee or representative is authorized to change this warranty in any way or grant any other warranty unless such change is made in writing and signed by an officer of HARDI at its head office.
  13. Any warranty work performed which will exceed \$400.00 MUST be approved IN ADVANCE by the Service Manager.
  14. Any pump replacement must be approved in advance by the Service Manager.
  15. Claims under this policy must be filled with HARDI within thirty (30) days of work performed or warranty shall be void.
  16. Parts requested must be returned prepaid within thirty (30) days for warranty settlement.
  17. Warranty claims must be COMPLETELY filled out properly or will be returned.

### DISCLAIMER OF FURTHER WARRANTY

THERE ARE NO WARRANTIES, EXPRESSED OR IMPLIED, EXCEPT AS SET FORTH ABOVE. THERE IS NO WARRANTY OR MERCHANTABILITY. THERE ARE NO WARRANTIES WHICH EXTEND BEYOND THE DESCRIPTION OF THE PRODUCT CONTAINED HEREIN. IN NO EVENT SHALL THE COMPANY BE LIABLE FOR INDIRECT, SPECIAL OR CONSEQUENTIAL DAMAGES (SUCH AS LOSS OF ANTICIPATED PROFITS) IN CONNECTION WITH THE RETAIL PURCHASER'S USE OF THE PRODUCT.



## WARRANTY REGISTRATION CERTIFICATE



In order to qualify for HARDI warranty, this certificate MUST be completely filled in, signed and mailed to HARDI INC. within 30 days of delivery of the sprayer.

**SPRAYER MODEL:** \_\_\_\_\_  
(Full Description)

**SPRAYER ORDER NO.** \_\_\_\_\_ **SERIAL NO.** \_\_\_\_\_

We, the undersigned dealer and purchaser, hereby certify that the above machine was purchased on the date indicated below.

**DEALER NAME** \_\_\_\_\_  
**ADDRESS** \_\_\_\_\_ **PHONE:** \_\_\_\_\_

**CITY** \_\_\_\_\_ **STATE** \_\_\_\_\_ **ZIP CODE** \_\_\_\_\_

**PURCHASER NAME** \_\_\_\_\_  
**ADDRESS** \_\_\_\_\_ **PHONE:** \_\_\_\_\_

**CITY** \_\_\_\_\_ **STATE** \_\_\_\_\_ **ZIP CODE** \_\_\_\_\_

**NO. OF ACRES FARMED** \_\_\_\_\_ **MAJOR CROPS** \_\_\_\_\_

**PURCHASER SIGNATURE** \_\_\_\_\_

**DEALER SIGNATURE** \_\_\_\_\_

**DATE OF PURCHASE** \_\_\_\_\_

\*\*\*\*\*

**FOR OFFICE USE:**  
**REGISTRATION DATE:** \_\_\_\_\_  
**CERTIFICATE #** \_\_\_\_\_

