

# HARDI® SPRAYERS

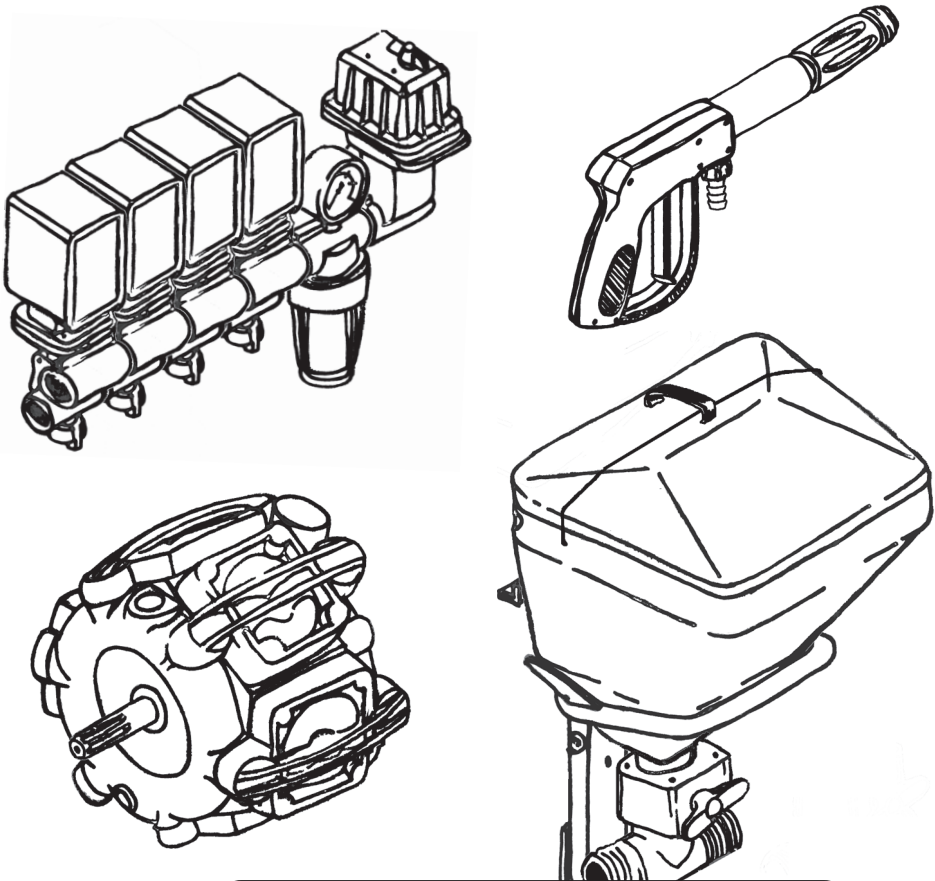

Supplement to  
**NAVIGATOR**  
550M, 800M, 1000M Centrifugal  
Operator's Manual

67801403 (8/10)

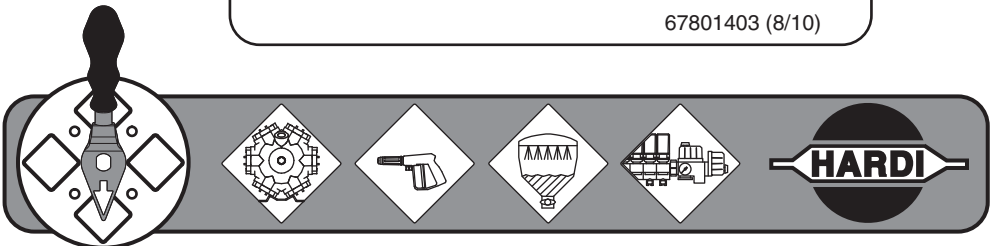





**Supplement to  
NAVIGATOR  
550M, 800M, 1000M Centrifugal  
Operator's Manual**

67801403 (8/10)

HARDI® reserves the right to make changes in design, material, or specification without notice thereof. HARDI® and other product names are registered trademarks of HARDI® Inc. in the U.S. and in other countries.





Dear Owner,

Thank you for purchasing a HARDI® product and welcome to the ever-increasing family of HARDI® sprayer owners.

Our sprayers and accessories are rapidly becoming a familiar sight on North American farms. We believe that this results from growers becoming increasingly conscious of crop protection input costs and the vital need for cost effective spray application equipment.

Please take the time to thoroughly read the Operator's Manual before using your equipment. You will find many helpful hints as well as important safety and operation information.

Some of the features on your HARDI® sprayer were suggested by growers. There is no substitute for "on farm" experience and we invite your comments and suggestions. If any portion of this instruction book remains unclear after reading it, contact your HARDI® dealer or service personnel for further explanation before using the equipment.

**For Product, Service or Warranty Information:**

- Please contact your local HARDI® dealer.

**To contact HARDI® directly:**

- Please use the HARDI® Customer Service number: 1-866-770-7063
- Or send your email to [CUSTSERV@hardi-us.com](mailto:CUSTSERV@hardi-us.com)

**Visit us online at: [www.hardi-us.com](http://www.hardi-us.com)**

**HARDI® NORTH AMERICA INC.**

1500 West 76th St.  
Davenport, Iowa 52806  
Phone: (563) 386-1730  
Fax: (563) 386-1710

337 Sovereign Rd.  
London, Ontario N6M 1A6  
Phone: (519) 659-2771  
Fax: (519) 659-2821

Sincerely,

Dale M. Szuminski  
President



## 1.0 INTRODUCTION

This supplement is to be used in conjunction with the "NAVIGATOR 550M, 800M, 1000M Centrifugal Operator's Manual" (Hardi® part no. 10613903).

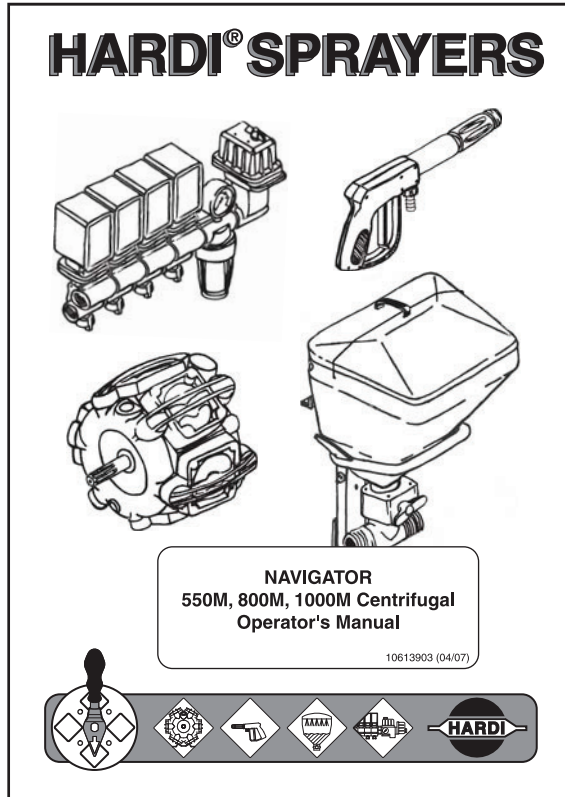

It includes setup and operating instructions for models equipped with the Spraybox II control box and 39-pin wiring. The updated two year Warranty Policy has also been included.

The section numbers in this supplement correspond to the section numbers in the Operator's Manual where this information would be found. For example, section **3.A** in this supplement is the first supplement (**A**) to section **3** in the Operator's Manual. Any following supplements are labeled **B**, **C**, etc.

## 3.A Electrical Connections

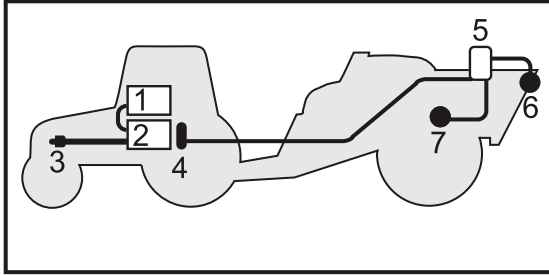
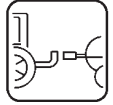

### Overall description

1. Controller (optional)
2. Spraybox II
3. To 12 Volt power supply
4. Multi-wire plug and cable
5. Junction box (on sprayer)
6. Flow transducer
7. Speed transducer

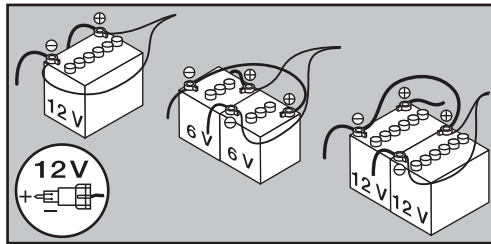

### Power supply

Power requirement is 12V DC. Note polarity! The wires must be at least 10 awg. (4.0 mm<sup>2</sup>) to ensure a sufficient power supply. For the operating unit, the tractor circuit should have an 8 Amp fuse. The supplied power connector is standard on most newer tractors. If using a tractor with a different power connector, it is necessary to disassemble connector and attach the wires to the actual tractor connector.

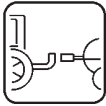

## Control boxes

The Spraybox and controller (optional) are fitted in the tractor cabin at a convenient place. HARDI® recommends using an electric distribution box (ref. no. 817925) to ensure a good power supply to various 12V attachments.

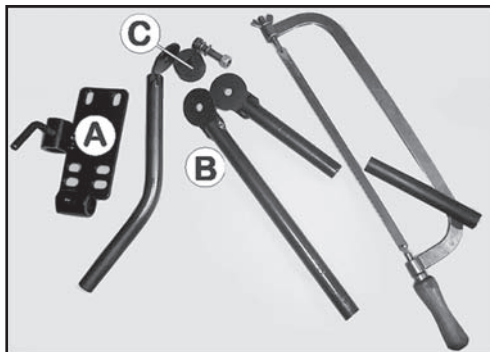

## Installation of control unit brackets

The supplied tractor pillar bracket **(A)** has a hole spacing of 3.9 in. (100mm) and 4.7 in. (120mm). Check tractor instructions manual for information regarding attachment points.

Three tubes **(B)** are supplied. One, two or all three may be used. They can be bent and shortened. A spacer **(C)** is also supplied to allow further attachment possibilities. Find the best solution for your tractor or vehicle.

Tube **(B)** plate is staggered, so if correctly orientated, all boxes will line up.



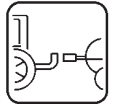

### **Connect sprayer (39 pin plug) to Spraybox**

When connecting the 39 pin plug from the sprayer, note the lock tab **(A)** clicks in place to secure the plug in the socket.

When disconnecting the plug, the metallic tab must be pushed back before the plug is pulled out.



### **Speed transducer for tractor/sprayer**

Note the following if the speed transducer is fitted to the tractor:

The speed transducer is an inductive type. It requires a metallic protrusion (e.g. bolt head) to pass by it to trigger a signal. Recommended distance between protrusion and transducer is 1/8" to 3/16" (3 to 5 mm).



## 4.A Adjustment Of The ESC Controls

### ESC operating unit

1. Adjustment screw for constant boom pressure
2. Pressure control valve
3. Distribution valves
4. System pressure gauge
5. System pressure filter

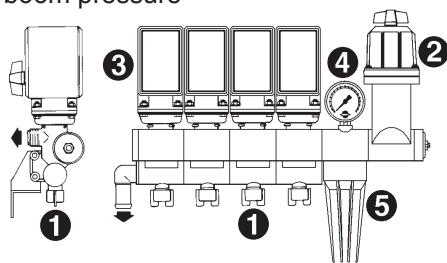

### Spraybox II

- A. Power switch
- B. Manual pressure regulation
- C. Main ON/OFF
- D. End nozzle (Left/OFF/Right)\*
- E. Foam marker regulation\*
- F. Foam marker (Left/OFF/Right)\*
- G. Boom section valves
- H. Valve function A-B\*

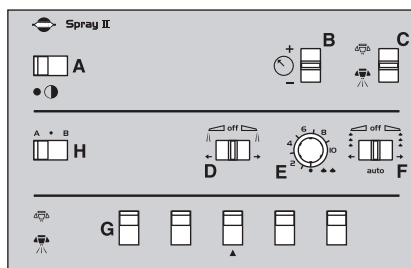

\*optional equipment

1. Choose the correct nozzle (see manual). Make sure that all the nozzles are the same type and capacity.
2. With the tractor in neutral, engage the tractor hydraulic lever (or P.T.O.) to start the pump. Adjust the R.P.M.'s until the number of revolutions corresponds to the intended traveling speed.
3. Open or close Agitation knob located at the top of the Manifold Control Panel depending on whether pressure agitation is required. (Remember pressure agitation takes 5% to 10% of pump output).
4. Turn power switch **(A)** and main ON/OFF switch **(C)** to the "ON" position.
5. Make sure all boom section valve switches **(G)** are also in the "ON" position. All nozzles should be spraying at this time.
6. Hold pressure regulating switch **(B)** up **(+)** or down **(-)** until desired pressure is shown on the pressure gauge **(4)**.

## 4.B Adjustment of Constant Pressure

**Note:** Adjust the constant boom section pressure one section at a time as follows: (Start with the valve turned closed before adjusting).

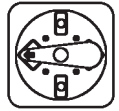

1. Shut-off the first boom section valve switch **(G)**.
2. Turn the adjusting screw **(1)** until the control unit pressure gauge **(4)** again shows the same pressure as set in step 6 (Section 4.A). (Turn the screw clockwise for higher pressure, counterclockwise for lower pressure).
3. Turn the boom section valve switch **(G)** back on.
4. Repeat steps 1 through 3 for the remaining boom section valves.

**Note:** Hereafter adjustment of the constant boom pressure will only be needed if you change to nozzles with other capacities, but not required if only changing pressure or application rate using the same nozzles.

5. Operating the control unit while driving: In order to shut off the entire boom, turn ON/OFF switch **(C)** to "Off" position. This returns all the pump outputs to the tank through the return system. The diaphragm antidrip valves ensures instantaneous closing of all nozzles.

In order to shut off one or more sections of the boom, switch one or more unneeded boom section valves **(G)** to "Off" position. The constant pressure device ensures that the pressure does not increase in the sections which are still operating.

In case of electrical failure, it is still possible to manually override all functions of the operating unit. To operate manually, disconnect the multiplug from the spraybox first and operate the handles by hand. It is possible to change pressure, turn boom sections on or off, or shut off the complete control unit manually.

**IMPORTANT:** *When the sprayer is stored, the spraybox and the multiplug must be protected against moisture and dirt. A plastic bag may be used to protect the multiplug. Store the control box in a clean dry place.*



## 9.0 WARRANTY POLICY AND CONDITIONS

HARDI® NORTH AMERICA INC. , 1500 West 76th Street, Davenport, Iowa, USA and 337 Sovereign Road, London, Ontario, Canada hereinafter called "HARDI®", offers the following limited warranty in accordance with the provisions below to each original retail purchaser of its own manufacturer, from an authorized HARDI® dealer that such equipment is at the time of delivery to such purchaser, free from defects in material and workmanship and that such equipment will be warranted for a period of one year from the time of delivery to the end user, providing the machine is used and serviced in accordance with the recommendations in the Operator's Manual and is operated under normal farm conditions.

1. This limited warranty is subject to the following exceptions:
  - a) Parts of the machine not manufactured by HARDI®, (i.e. engines, tires, tubes, electronic controls and other components or trade accessories, etc.) are not covered by this warranty but are subject to the warranty of the original manufacturer. Any claim falling into this category will be taken up with the manufacturer concerned.
  - b) This warranty will be withdrawn if any equipment has been used for purposes other than for which it was intended or if it has been misused, neglected, or damaged by accident, let out on hire or furnished by a rental agency. Nor can claims be accepted if parts other than those manufactured by HARDI® have been incorporated in any of our equipment. Further, HARDI® shall not be responsible for damage in transit or handling by any common carrier and under no circumstances within or without the warranty period will HARDI® be liable for damages of loss of use, or damages resulting from delay or any consequential damage.
2. We cannot be held responsible for loss of livestock, loss of crops, loss because of delays in harvesting or any other expense or loss incurred for labor, supplies, substitute machinery, rental for any other reason, or for injuries either to the owner or to a third party, nor can we be called upon to be responsible for labor charges, other than originally agreed, incurred in the removal or replacement of components.
3. The customer will be responsible for and bear the costs of:
  - a) Normal maintenance such as greasing, maintenance of oil levels, minor adjustments including the boom.
  - b) Transportation of any HARDI® product to and from where the warranty work is to be performed.
  - c) Dealer travel time to and from the machine or to deliver and return the machine from the service workshop for repair unless otherwise dictated by state law.
  - d) Dealer traveling costs.
4. Parts defined as normal wearing items, (i.e. Pump Diaphragms, Valves, O-rings, Tires and V-belts) are not in any way covered under this warranty.
5. This warranty will not apply to any product which is altered or modified without the express written permission of the HARDI® Service and Engineering Departments and/or repaired by anyone other than an Authorized HARDI® Dealer.
6. Warranty is dependent upon the strict observance by the purchaser of the following provisions:
  - a) That this warranty may not be assigned or transferred to anyone.
  - b) That the Warranty Registration Certificate has been correctly completed by dealer and purchaser with their names and addresses, dated, signed and returned to the appropriate address as given on the Warranty Registration Certificate within 30 days of delivery to the purchaser.
  - c) That all safety instructions in the operator's manual shall be followed and all safety guards regularly inspected and replaced where necessary.
7. No warranty is given on second-hand products and none is implied.

# WARRANTY POLICY AND CONDITIONS



8. Subject to the following terms, conditions and contributions, HARDI® extends the warranty on polyethylene tanks (excluding fittings, lids and gaskets) to FIVE YEARS on field sprayers and TEN YEARS on Orchard and Vineyard sprayers. To qualify for this extended warranty, the tank must be drained and flushed with fresh water after each day's use. HARDI®'s liability is limited to replacement of defective parts FOB our plants in Davenport, IA and London, Ontario, Canada at no cost to the purchaser for the first twelve months after date of purchase; at 20% of the then current retail price during the second year; at 40% during the third year; at 60% during the fourth year; and at 80% during the fifth year. This extended warranty is subject, in each instance, to the tank being inspected and approved for replacement or repair by HARDI® personnel before HARDI® will accept any liability hereunder.
9. Subject to the following terms, conditions and contributions, HARDI® extends the warranty on HARDI® diaphragm pumps (excluding wearing parts such as diaphragms, valves and o-rings) to FIVE YEARS. To qualify for this extended warranty, the pump must be drained and flushed with fresh water after each day's use. HARDI®'s liability is limited to replacement of defective parts, FOB our plants in Davenport, IA and London, Ontario, Canada at no cost to the purchaser during the first twelve months after date of purchase; at 20% of the then current retail price during the second year; at 40% during the third year; at 60% during the fourth year; and at 80% during the fifth year. This five year extended warranty is subject, in each instance, to the pump being inspected and approved for replacement or repair by HARDI® personnel before HARDI® will accept any liability hereunder.
10. HARDI® reserves the right to incorporate any change in design in its products without obligation to make such changes on units previously manufactured.
11. The judgement of the HARDI® Service Department in all cases of claims under this warranty shall be final and conclusive and the purchaser agrees to accept its decisions on all questions as to defect and the repair or exchange of any part or parts.
12. No employee or representative is authorized to change this warranty in any way or grant any other warranty unless such change is made in writing and signed by the CEO in the Davenport office. Approval of warranty is the responsibility of the HARDI® Service Department.
13. Any warranty work performed which will exceed \$1000.00 MUST be approved IN ADVANCE by the Service Department. Warranty claims filed without prior approval will be returned.
14. ANY pump replacement MUST be approved by the HARDI® Service Department.
15. Claims under this policy MUST be filed with the HARDI® Service Department within thirty (30) days of when the work is performed or warranty shall be void unless prior arrangements are made.
16. Parts which are requested for return by the HARDI® Service Department must be returned prepaid within thirty (30) days for warranty settlement.
17. Warranty claims must be COMPLETELY filled out including part numbers and quantities or claims will be returned to the submitting dealer.

## DISCLAIMER OF FURTHER WARRANTY

THERE ARE NO WARRANTIES, EXPRESSED OR IMPLIED, EXCEPT AS SET FORTH ABOVE. THERE ARE NO WARRANTIES WHICH EXTEND BEYOND THE DESCRIPTION OF THE PRODUCT CONTAINED HEREIN. IN NO EVENT SHALL THE COMPANY BE LIABLE FOR INDIRECT, SPECIAL OR CONSEQUENTIAL DAMAGES (SUCH AS LOSS OF ANTICIPATED PROFITS) IN CONNECTION WITH THE RETAIL PURCHASER'S USE OF THE PRODUCT.





**For Product, Service or Warranty Information:**

- Please contact your local HARDI® dealer.

**To contact HARDI® directly:**

- Please use the HARDI® Customer Service number: 1-866-770-7063

- Or send your email to: [CUSTSERV@hardi-us.com](mailto:CUSTSERV@hardi-us.com)

Visit us online at: [www.hardi-us.com](http://www.hardi-us.com)

**HARDI® NORTH AMERICA INC.**

1500 West 76th St.  
Davenport, Iowa 52806

Phone: (563) 386-1730

Fax: (563) 386-1710

337 Sovereign Rd.  
London, Ontario N6M 1A6

Phone: (519) 659-2771

Fax: (519) 659-2821

