

HARDI NOVA

Instruction book

673176-GB-2002/01

Illustrations, technical information and data in this book are to the best of our belief correct at the time of printing. As it is HARDI INTERNATIONAL A/S policy permanently to improve our products, we reserve the right to make changes in design, features, accessories, specifications and maintenance instructions at any time and without notice.

HARDI INTERNATIONAL A/S is without any obligation in relation to implements purchased before or after such changes.

HARDI INTERNATIONAL A/S cannot undertake any responsibility for possible omissions or inaccuracies in this publication, although everything possible has been done to make it complete and correct.

As this instruction book covers more models and features or equipment, which are available in certain countries only, please pay attention to paragraphs dealing with precisely your model.

Table of contents

2. Operator safety	4	9. Quick guide	41
Safety instructions	4	10. Fault finding	43
Glossary	5	Alarm numbers and their meaning	43
3. System layout	6	Internal alarms	44
4. Fitting instructions	7	Problems and solutions	45
Basic tractor equipment	7	11. Technical specifications	46
Battery connection	7	Compatibility with Agrocom and MF Fieldstar terminals	46
5. Functional description	10	12. Records	49
HARDI NOVA Display 4100	10	13. Parts	50
Menus	11		
Result menu	11		
Set-up menu	12		
Explanation of the symbols	13		
HARDI NOVA SET 4500	15		
Free programmable menu keys	15		
Feature keys	15		
Multi-functional keys	16		
HARDI NOVA Grip 4510	17		
ADD-ON modules	18		
HARDI NOVA Hydraulic 4600	18		
HARDI NOVA TWIN 4520	19		
HARDI NOVA Track 4610	20		
6. Initial operation	24		
Application rate	24		
Reset registers	24		
Boom and section controls	25		
7. Basic set-up	26		
Registers	26		
Start/Stop/Save counting	26		
Display counters	26		
Flowmeter calibration	27		
Theoretically calibration	27		
Practical calibration – Nozzle method	28		
Practical calibration – Tank method	29		
Circulation Semi-continue System	30		
Set-up for tank contents or HARDI FILLMETER or Tank Control	31		
Calibration procedure for HARDI FILLMETER	31		
Speed calibration	32		
Setting of AUTO ON/OFF speed	34		
Adjust boom width	35		
Regulation constant adjustment	36		
Select units (US or Metric)	37		
Print menu	38		
Data dump	38		
Register Printout	39		
Use with site specific application signal (GPS)	39		
8. Storage	40		

2. Operator safety

2. Operator safety

The HARDI NOVA system is specified only for agricultural use. Use outside this area is regarded as unspecific.

The manufacturer does not accept liability for damages to persons or property as a result from unspecific use. In such cases all risks are in responsibility of the user. Specified implementation also includes adhering to the operation and maintenance conditions stipulated by the manufacturer.

The relevant accident prevention regulations as well as other recognised safety, industrial medical and road traffic rules must be adhered to. The manufacturer does not accept liability in cases where independent modifications have been made to the HARDI NOVA system.



Warning

Attention

Note

Always watch for this symbol for important safety precautions.

Pay attention! Be alert! Your safety is involved.

Always follow recommended precautions and safe operating practices.

Read this manual before using the equipment for the first time.

Do not remove any safety devices or shields.

Never service, clean or repair a machine while it is operating.

Safety instructions

- Carefully read all the safety messages in the manual and the safety labels fitted to the machine. Keep safety labels in good condition. Replace missing or damaged safety labels. Be sure that all new equipment components include all current safety labels. Replacement safety labels are available from your authorized HARDI dealer.
- Learn how to operate the sprayer and controls properly. Do not let anyone operate the sprayer without proper instructions.
- Keep your sprayer and accessories in proper working condition. Unauthorized modifications or use, may impair the function and/or safety and affect the machines' life.
- Disconnect all electrical power before servicing.
- If an electric welder is used on the equipment or anything connected to the equipment, disconnect the 12V power leads from the battery before welding.
- Keep children away from the equipment.
- Do not use a high pressure cleaner to clean the electronic components.

A HARDI NOVA Quick guide (Ref. no. 978107) is included with this book for safe, easy in-field operation.

2. Operator safety

Glossary

Module	A HARDI NOVA control panel fitted on the tractor.
Spraycom	The HARDI NOVA sprayer computer unit. It is fitted on the sprayer.
Transducer	Device that transforms variations to a signal. Also called a sensor.
EC	HARDI electric control unit.
EVC	HARDI electric control unit (without main valve).
LBS/ISO	Plug and socket assembly.
LED	Light emitting diode.
PPU	Pulses per unit: For flow calibration it is pulses for one litre. For speed calibration it is pulses for 100 metre.
GPS	Global Positioning System.

3. System layout

3. System layout

HARDI NOVA system with basic tractor equipment and sprayer control units.

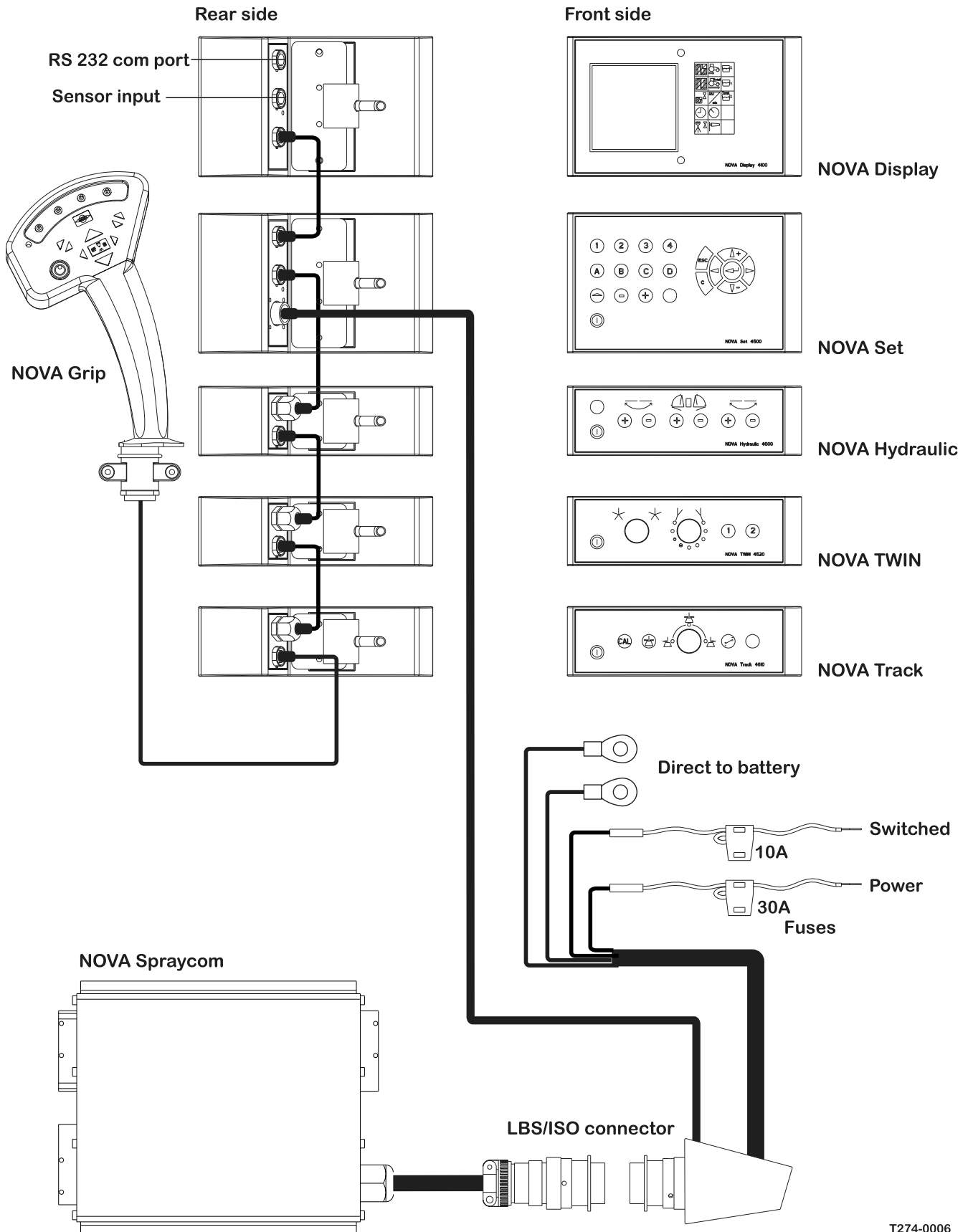

T274-0006

4. Fitting instructions

4. Fitting instructions

Basic tractor equipment

The basic tractor equipment upgrades a standard tractor to a LBS-tractor. It consists of the LBS socket (which is normally mounted at the rear of the tractor), the connection to the battery and the connection to the HARDI NOVA Set 4500.

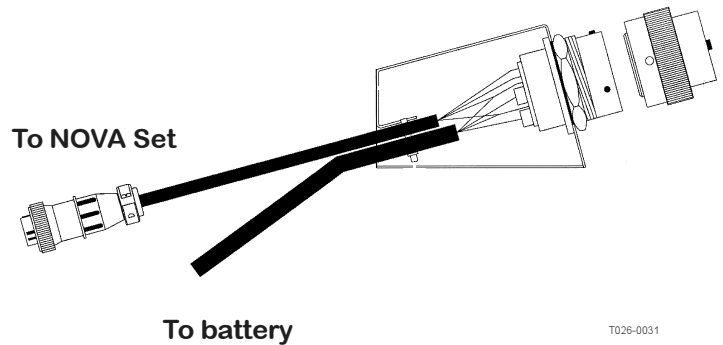

Battery connection

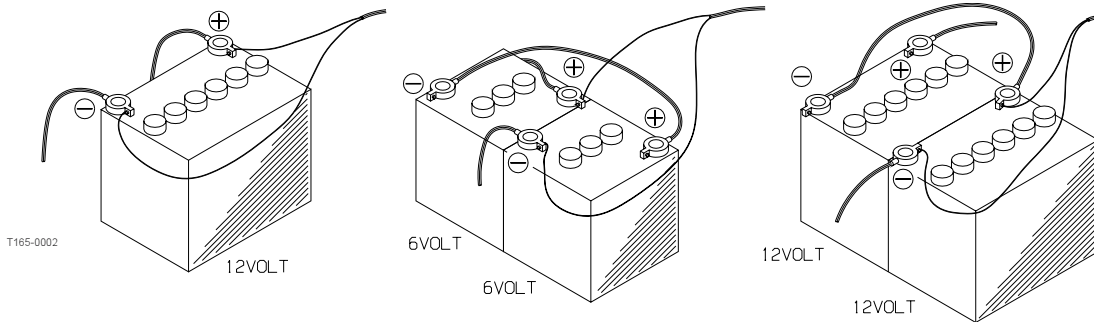

Supplied

1. Butt splice with 10A fuse
2. Butt splice with 30A fuse
3. Ring crimp terminal (blue, 3pcs)
4. Ring crimp terminal (yellow, 1pcs)

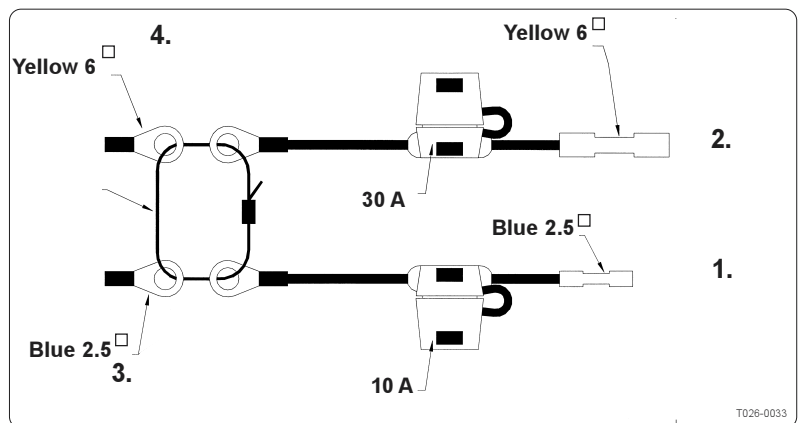

Installation instructions

Note: The thick 6 mm² wire with the 30 Amp fuse must be connected directly to the battery. Warranty is void if this is not done.

The 2.5 mm² wire with the 10 Amp fuse may be connected directly to the battery or over the ignition.

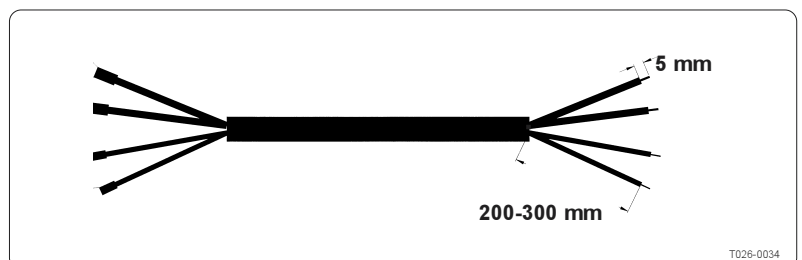

4. Fitting instructions

1. Cut the battery cable to the required length and strip the free cable end and the single wires.
2. Splice the red wires (+12 Volts) with the following butt splice:
2.5 mm² butt splice - blue
6 mm² butt splice - yellow
3. Put the ring crimp terminal on the black wires as follows:
2.5 mm² ring crimp terminal - blue
6 mm² ring crimp terminal - yellow
4. Crimp the connectors using pliers. Shrink both butt splices with a heat shrink gun or similar until glue comes out.

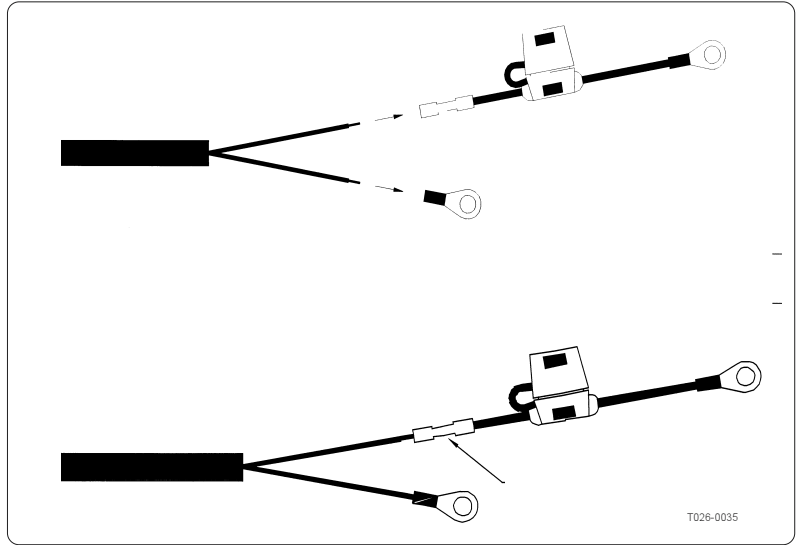

5. The supplied mounting bracket (A) is attached to the tractor cabin pillar. Hole spacing is 100 mm and 120 mm.

Check the tractor instructions manual for information regarding attachment points.

The NOVA modules are supplied with attachment brackets (D).

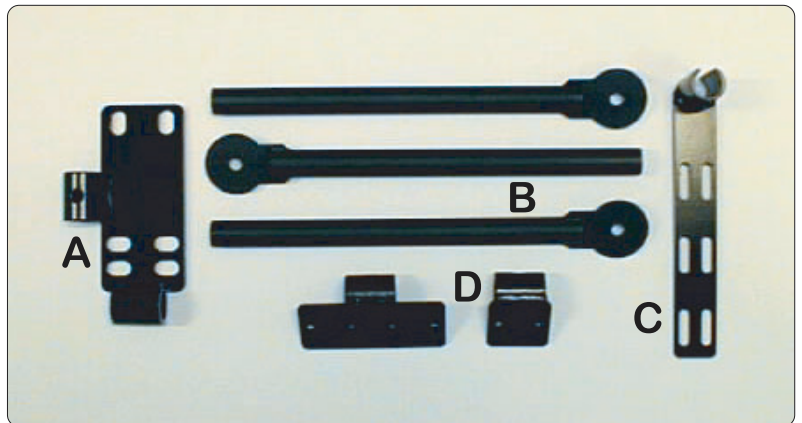

The NOVA Grip is fitted to the holder (C) and it is attached to the arm rest with the re-usable tape.

The holder should be bent to conform with the shape of the arm rest.

On some tractors, the holder can be bolted to the tractor seat or lower part of the arm rest.

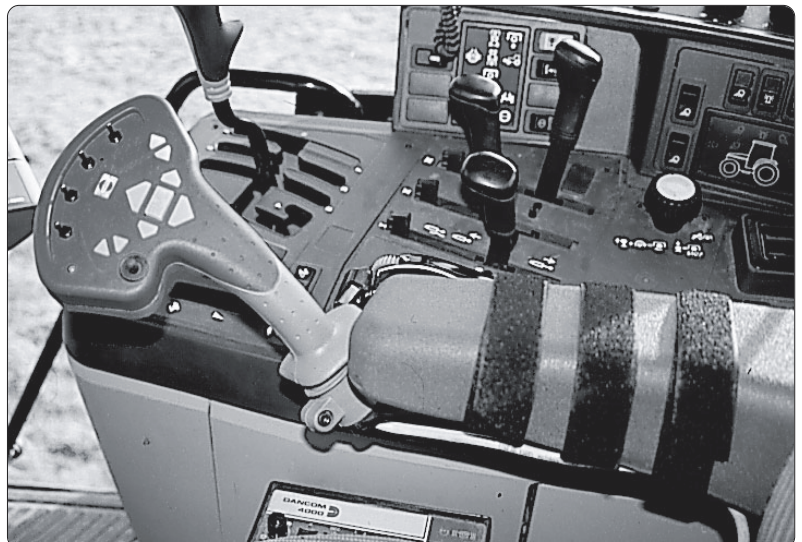

4. Fitting instructions

Some assembly combination suggestions are shown.

The modules can be mounted together or can be separated. For example, the Display could be located in front of the operator and the other modules on the side. An extension cable for separation is available. Reference number is 280097.

The supplied plastic disc is used as a spacer so the module group can be off set, for example, move it away from the window.

In this example, the tube from the pillar has had the plate bent at right angle.

The tubes (B) are shortened once the combination and location is determined.

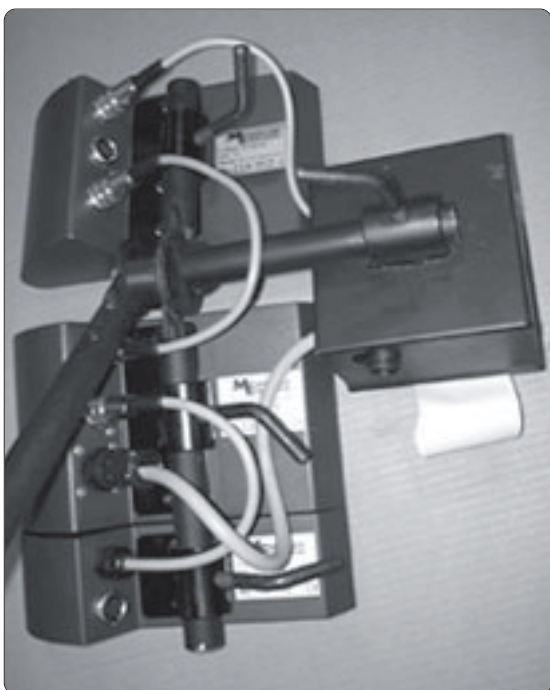
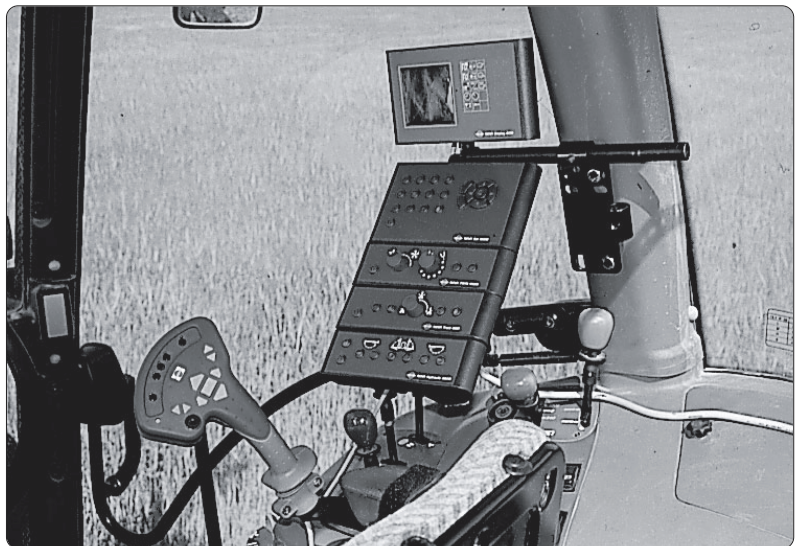
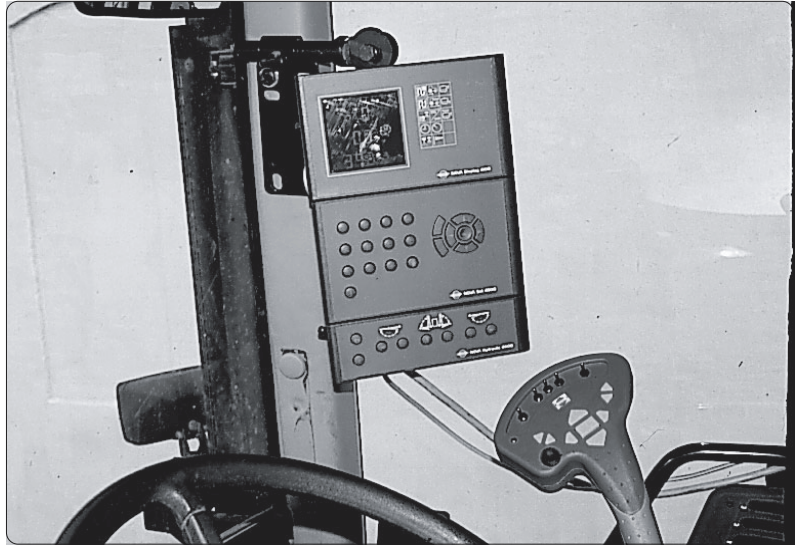

In the example to the left and below, HARDI NOVA is mounted together with the printer module.



5. Functions description

5. Functional description

HARDI NOVA Display 4100

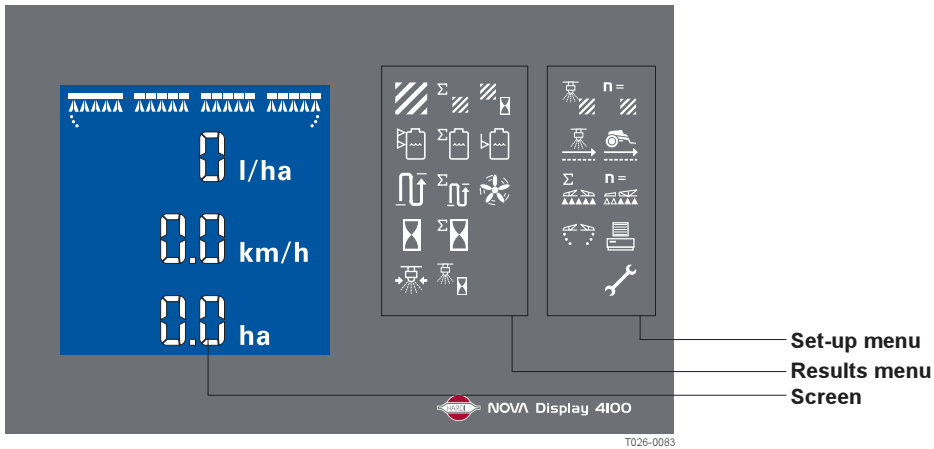

This module is divided into 3 columns: Screen, Results menu and Set-up menu as described in this chapter.

Screen

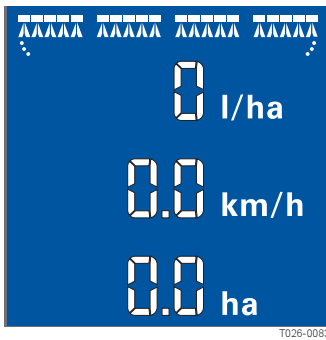

First row

Second row

Third row

Fourth row

The display consists of 4 rows. The upper 3 are fixed to specific information. The values on the last row vary, depending on the menu selected. A symbol is displayed right beside the value in the fourth row. This depends on the current submenu.

Sections and Foam marker

The first row displays the status of the programmed sections. Depending on the sprayer connected, up to nine sections can be shown. When the main valve is closed, the sections selected will be displayed without the spraying cone underneath the nozzles. If the main valve is open, all sections selected will be displayed with the spraying cone. Sections not selected (switched off on the NOVA Grip) are not shown at all.

The active foam markers are shown on the left or right hand side. When the foam marker is active,  will appear.

Examples:

All four sections are active. The right foam marker is active.



All four sections selected but switched off.



5. Functions description



Section 2 switched off, the other sections are working.



Sections 1 and 4 selected but switched off. Sections 2 and 3 not selected.

Application Rate

The second row permanently displays the current application rate.

Speed

The third row shows the current speed of the sprayer or tractor. Chapter 7 'Select Units' explains how to change the units. Normally the speed of the trailed sprayer is shown. If there is no possibility to determine the speed of the sprayer, the speed of the tractor can be measured and displayed. If the sprayer is not connected to the HARDI NOVA, and a speed sensor from the tractor is connected, only the speed will be shown on the display.

Working display

The fourth row shows a selected Result or Set-up value. The screen changes when an other menu in the Result or Set-up menu is selected.

Menus

The menus are background lit symbols on the right of the HARDI NOVA Display 4100. Two different menus are available: a Result and a Set-up menu. In the Result menu, only output values can be displayed. A modification and calibration of values is possible in the Set-up menu. The calibration allows modification of sensor constants according to values measured.

The symbols in the Result menu are always visible (even without any light in the cabin). The others only become visible when selected.

Result menu

Standard mode:

When the HARDI NOVA Set 4500 system starts up, the Result menu symbol on the upper left is highlighted and the matching value is displayed in the 4th row.

It is possible via the multi-function keys  to navigate within the Result menu.

5. Functions description

The Result menu consists of up to 13 values, which can be shown in the 4th row of the display. Each symbol represents one value. Only the symbols,



Area sprayed



Sprayed amount



Distance covered



Spraying hours

- can display up to 16 different values. The value shown with one of these symbols depends on the register setting defined in the Set-up menu. How to work with registers refer to Chapter 7 'Counters & Registers'.

The unit of the current display depends on the unit setting. Refer to Chapter 7 'Select Units' to change the current units.

Set-up menu









Set-up mode:



To enter the Set-up display mode press the  key.

All symbols in the Set-up menu are now switched on except the active symbol. This symbol is flashing.

Navigation within the Set-up menu is possible using the  keys.

Exiting the Set-up menu switches off all set-up menu symbols. The Set-up menu can be exited by pressing the  key.

A value in the Set-up menu can be changed by means of the  key. The current value is now flashing, indicating that the value can be changed. Changing the values can be done using the ,  or  keys. Pressing  in changing mode lets the system take over the new programmed value. Pressing the keys ,  or  leaves the changing mode without changing the value.

In submenus, the flashing symbol of the current submenu is displayed alongside the value in the 4th row of the display. Using the  and  key, the submenu can be changed. When  is pressed again, the symbol stops flashing and the value starts flashing. The value is now ready for changing.

If the new value is known, it can be set with the  and  keys. Pressing  will save the value and leave the input mode.

5. Functions description

Explanation of the symbols



TO26-0079

Re-setable counter displaying the sprayed area in the chosen register (register 1 to 16).
The current value will be shown when the icon is highlighted.



TO26-0002

Re-setable counter displaying the sprayed volume in the chosen register (register 1 to 16).
The current value will be shown when the icon is highlighted.



TO26-0003

Re-setable counter displaying the distance travelled in the chosen register (register 1 to 16).
The current value will be shown when the icon is highlighted.



TO26-0004

Re-setable counter displaying the amount of spraying hours in the chosen register (register 1 to 16).
The current value will be shown when the icon is highlighted.



TO26-0005

Spray pressure (optional).
The current value will be shown when the icon is highlighted.



TO26-0008

Summarized counter displaying the sum of the sprayed area.
The current value will be shown when the icon is highlighted.



TO26-0007

Summarized counter displaying the sum of the sprayed volume. This counter cannot be reset.
The current value will be shown when the icon is highlighted.



TO26-0008

Summarized counter displaying the sum of the distance travelled. This counter cannot be reset.
The current value will be shown when the icon is highlighted.



TO26-0009

Summarized counter displaying the sum of the spraying hours. This counter cannot be reset.
The current value will be shown when the icon is highlighted.



TO26-0010

Flow rate per minute.
The current value will be shown when the icon is highlighted.



TO26-0011

Area worked per hour.
The current value will be shown when the icon is highlighted.



TO26-0012

Counter displaying the sprayed volume. The initial amount of can be set in the 'Flow Calibration' menu.
The current value will be shown when the icon is highlighted.



TO26-0013

TWIN fan revolutions. (optional).
The current value will be shown when the icon is highlighted.

5. Functions description



T026-0021

Set application rate.

This menu point is active when the icon is highlighted.



T026-0022

Set or calibrate flow functionality.

This menu point is active when the icon is highlighted.



T026-0023

Set the total length of the boom.

This menu point is active when the icon is highlighted.



T026-0024

Set foam marker functionality (optional).

This menu point is active when the icon is highlighted.



T026-0026

Select active area/registers (register 1 to 16).

This menu point is active when the icon is highlighted.



T026-0027

Set or calibrate speed functionality.

This menu point is active when the icon is highlighted.



T026-0028

Set the number of nozzles placed on each section.

This menu point is active when the icon is highlighted.



T026-0029

Print or send data, and activation key for site specific application (GPS) (optional).

This menu point is active when the icon is highlighted.



T026-0030

Service menu (not used).

This menu point is active when the icon is highlighted.

5. Functions description

HARDI NOVA SET 4500

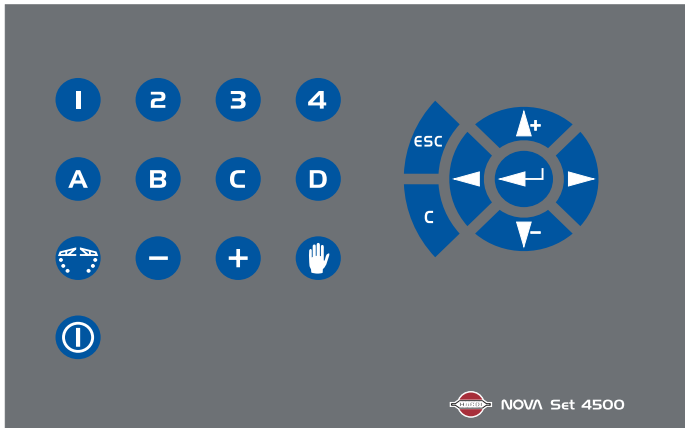

Free programmable menu keys

The keys **1**, **2**, **3** and **4** can be programmed to display a value of the Result menu without having to navigate through the menu.

Programming:

Select an item from the Result menu. The value will be displayed in the 4th row of the display. To store this item press and hold the selected button for about 3 seconds until a “bip” signal is heard.

Recall programmed item:

Push the selected button. The programmed value will be displayed and the corresponding item highlighted.

Feature keys

The keys **A**, **B**, **C** and **D** are feature keys each with a status LED to indicate on/off. Depending on the sprayer equipment these keys are used to control warning lights and/or spotlights. These functions will be programmed before delivery of the sprayer.

5. Functions description

Multi-functional keys

The  keys are used to operate the menus and to change submenus and values.

Functions of the single keys:



Escape the Set-up mode and restore the old Set-up value
Escape the Set-up display mode and change to Result menu mode



Reset the current register and **start** a new recording cycle.



Set-up mode: Reset Set-up value to minimum.



Result mode (automatic on): Reset the application rate to 100%.
Set-up mode, adjust value: Increase the value by single steps.
Set-up mode: Move up within the menu
Result mode: Move up within the menu



Set-up mode, adjust value: Decrease the value by single steps.
Set-up mode: Move down within the menu
Result mode: Move down within the menu



Menu mode: Move left in the menu
Input mode (only Set-up): Leave the input line and go back to set-up menu



Menu mode: Move right in the menu
Input mode (only Set-up): Leave the input line and go back to set-up menu



Result mode: Enter the Set-up mode
Set-up mode: Go to submenu selection, value input or accept new value



This key toggles between automatic and manual spraying.



Automatic spraying mode: increase application rate in 10% steps.
Manual spraying mode: increase spraying pressure



Automatic spraying mode: decrease application rate in 10% steps.
Manual spraying mode: decrease spraying pressure



This key switches the NOVA Set, NOVA Grip and NOVA Display On or Off the whole system.



Not used.

5. Functions description

HARDI NOVA Grip 4510

The NOVA Grip is an ergonomically remote unit that can be easily mounted inside the tractor cabin. All common functions required during normal spraying can be operated with the Grip. The picture below illustrates the functions of the single keys.

The NOVA Grip cannot be switched ON or OFF separately. It receives the power supply from the NOVA Set. It is therefore automatically switched ON or OFF with the NOVA Set.

The mini joystick (Foam marker control) can be configured for manual control of the drawbar, if foam marker is not fitted. Then the left and right positions on the joystick will be used for drawbar movements.



NOTE: The manual drawbar function is not compatible with ACT terminals.

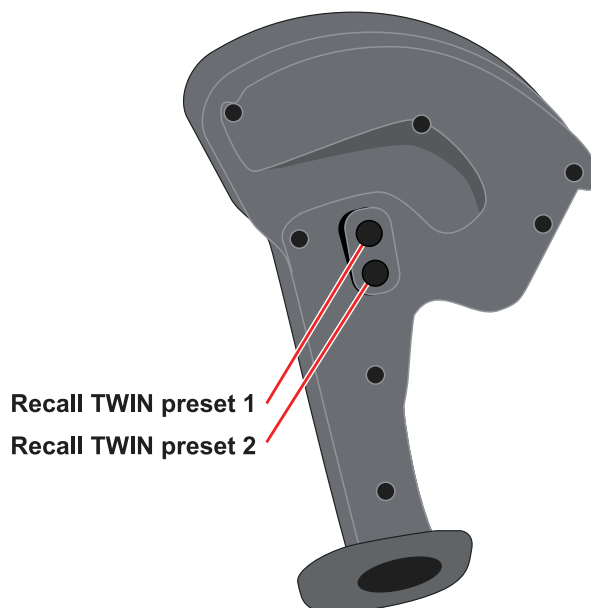
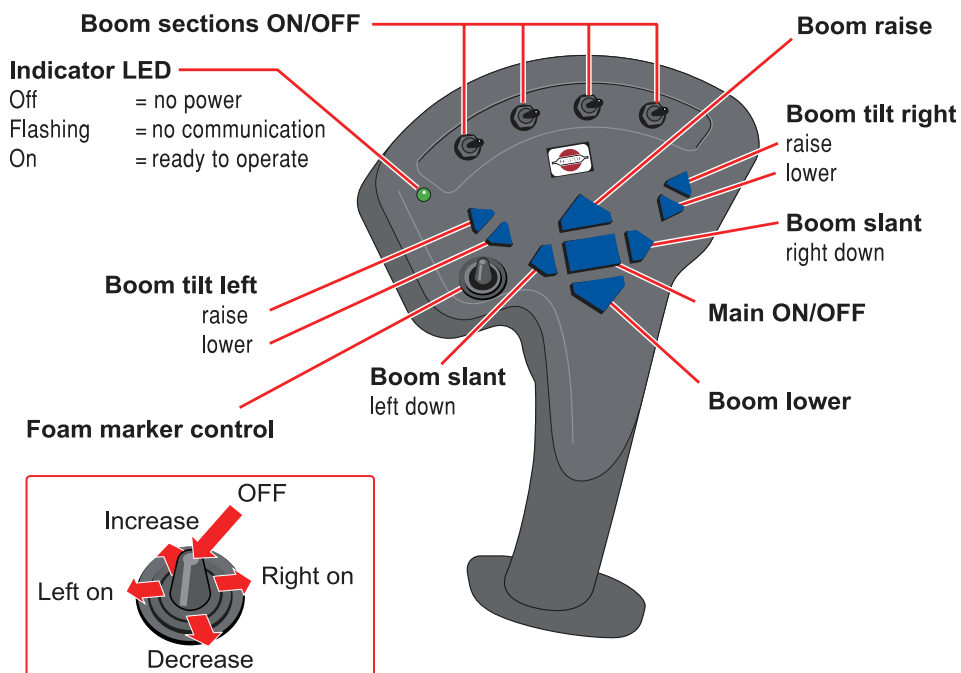

T026-0068a+b

5. Functions description

ADD-ON modules

The ADD-ON modules are added components depending on the sprayer.

The ADD-ON modules, NOVA Hydraulic 4600, NOVA Track 4610 and NOVA TWIN 4520 are equipped with an indicator LED in the  switch that shows the following states:

Indicator LED	Function
OFF	The system is off.
Flashing	Power is on, but no communication connection to NOVA Set and NOVA Display.
ON	Power is on and communication connection works

HARDI NOVA Hydraulic 4600

This module controls the hydraulic functions of the sprayer. The functions are fold, unfold the booms and pendulum lock (if found on the boom). It can be switched off separately when not needed or to prevent undesired operation. When the module is turned ON the pendulum lock will be in same state as it was when turned off last time. When pendulum lock button is activated the LED in it will flash and afterwards light up constantly.

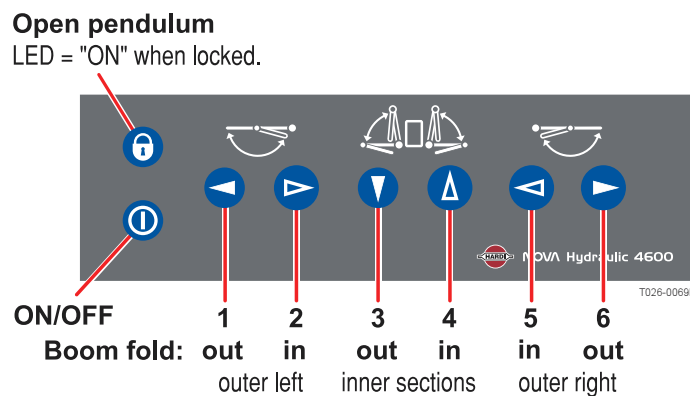

Function

The module can be operated with up to 4 key presses at same time. Depending on the sprayer configuration and number of hydraulic valves for boom operation there can be different ways of operation.

The button-operation chart is divided in two parts. Upper part refer to sprayers fitted with hydraulic cylinders for each outer section. Lower part refer to sprayers with a single cylinder for outer folding. The numbers in the chart refer to button numbers in the figure above.

		Inner section		Outer section	
		Left	Right	Left	Right
Single press	Out	3		1	6
	In	4		2	5
Multi press	Out	1 and 3	4 and 6	1	6
	In	2 and 3	4 and 5	2	5

Single press	Out	3		1 or 6	
	In	4		2 or 5	
Multi press	Out	1 and 3	4 and 6	1 or 6	
	In	2 and 3	4 and 5	2 or 5	

chart buttons -GB

5. Functions description

HARDI NOVA TWIN 4520

This module controls the TWIN functionality of the sprayer.

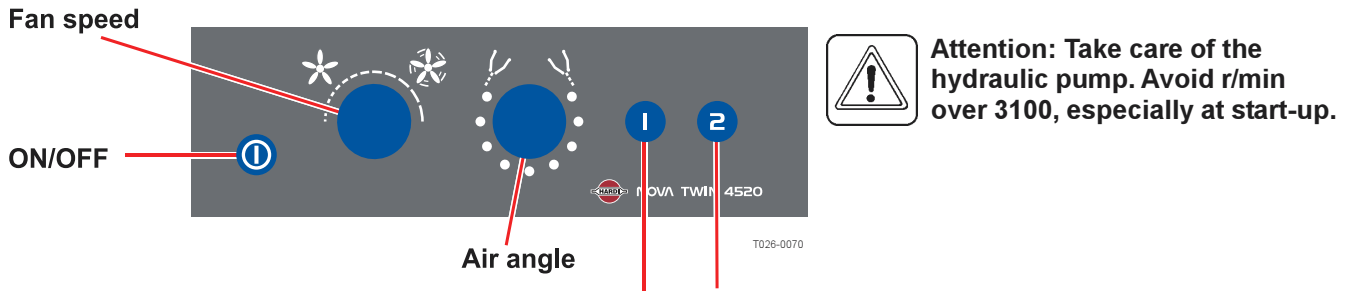

Fan speed and air angle: Preset 1 Preset 2

This module can be switched on and off separately with the button. When switched on, no function is active. Automatic mode will be switched on, when a pre-set key is pushed or the knobs of the air angle or fan speed are operated manually.



The Fan Knob

By changing the position of the fan speed knob, the 4th row of the display shows the percentage value illustrated with , and the fan speed will be adjusted.

The -sign and the percentage fan speed value will be showed for about 3 seconds, and then display goes back to previous view.



The Air Angle Knob

If the position of the air angle potentiometer is changed, the angle will be adjusted. The LED's around the air angle knob show the pre-set value of the air angle. The parameters on the machine will be set according to the values displayed.



The Preset Keys

By pushing one of the pre-set keys, the TWIN module activates the appropriate stored parameters for fan speed and air angle.

By pressing the TWIN module pre-set key for more than 3 seconds, a new setting of the TWIN fan speed and the air slot angle are memorized and a “bip” will be heard.

When spraying a pre-set setting can also be called by the buttons on backside of the Grip-module.

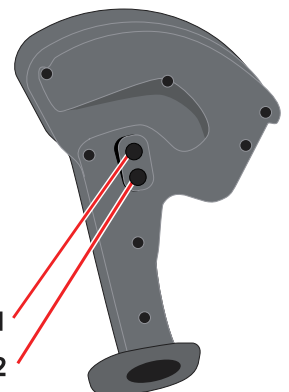

Recall TWIN preset 1

Recall TWIN preset 2

5. Functions description

HARDI NOVA Track 4610

This module controls the steering drawbar of the sprayer. The figure describes the functions of the keys and LED's.

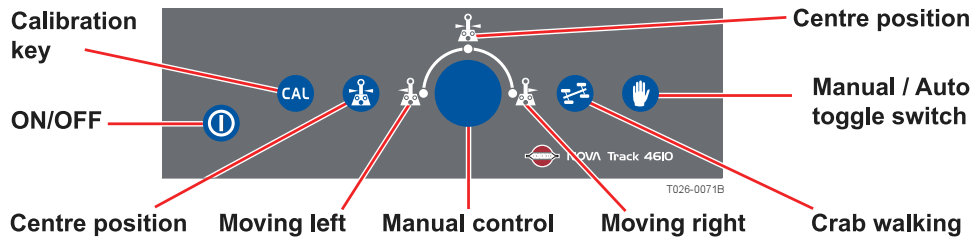

Warning:

When reversing, centre the drawbar and set to manual. Failure to do so may damage the drawbar.



Function



ON/OFF

Starts the NOVA Track module with manual mode active.

The module can be switched on and off separately. When the HARDI NOVA system is started, the NOVA Track module is electrically off.

The LED's in the keys  and  are red. If the crab walking regulation was previously selected, the  is also red.



Calibration key.

For calibration use. See following pages.



Centre Position key.

Moves the drawbar to centre position. The key must be pressed until the position is reached. As soon as the key is released, the movement will stop. This key is only effective in manual mode.



Crab Walking key.

If this function is on, the LED in this key is red. This is used, when driving on a slope.

Two types of crab walking are possible:

Slope sensor fitted: If a slope sensor is fitted on the frame of the sprayer, a "semi automatic" crab walking is possible. In crab walking mode it is now possible to adjust the crab walk of the sprayer by turning the knob. With this, a ratio between the applied shifting and the frame slope is set. If the slope changes now, the shifting of the drawbar is corrected proportionally to the programmed ratio. The ratio can be changed at any time by turning the knob, when the crab walking mode is active.

No slope sensor fitted: The "manual crab walking" is used. With this function the sprayer position can be adjusted offcenter with the knob. In the crab walking mode the automatic mode is still working. When set to manual mode, the current adjustment is cancelled.



Warning: Only use the crab walk function in hilly conditions. If crab walk is used on flat fields, abrupt and wide drawbar movements may be the result.

5. Functions description



Manual / Auto toggle switch.

If the LED is red the task is set to manual mode.

The automatic mode is activated by pressing the key. If the automatic mode is active, the LED in this key is off. If the speed decreases below 1.5 km/h, the automatic mode is disabled, until the speed increases to 1.5 km/h or more.

If the speed increases above 15 km/h, the function goes to manual mode. This is displayed with the three LED's around the knob. These LEDs are all switched on. If the speed decreases below 15 km/h again, then the Track module is still in manual mode, but the three LED's are switched off.



The Knob.

It is used to shift the drawbar position to the left or to the right. For manual control, the knob must be turned counterclockwise or clockwise. The LED on the left side of the knob is on when the sprayer moves to the left, and the LED on the right side when the sprayer moves to the right. The LED in the middle is on when the Drawbar is in centre position.

In automatic mode, the knob has only an effect when the crab walking is activated. The LED's left and right beside the knob show the eventual movement of the sprayer.

Safety functions

Mechanical drawbar lock

When the mechanical drawbar lock is mounted, the NOVA Track automatically goes to manual mode and all 3 position LED's at the knob will flash.



Warning: Drawbar lock MUST be in place during road transport.

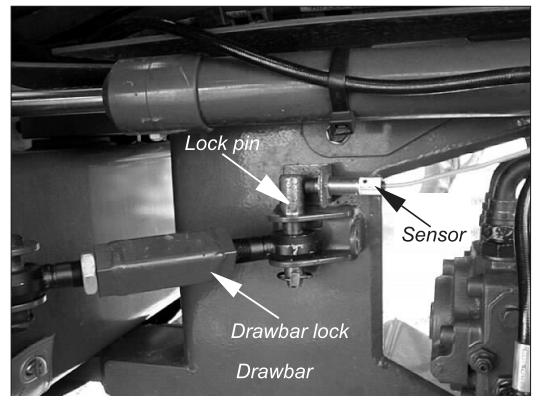

Ladder sensor

If the ladder sensor recognizes that the ladder is down, then NOVA Track module automatically blocks any drawbar movement to prevent damage on ladder and all 3 position LED's at the knob will flash. It does not change the actual working mode.

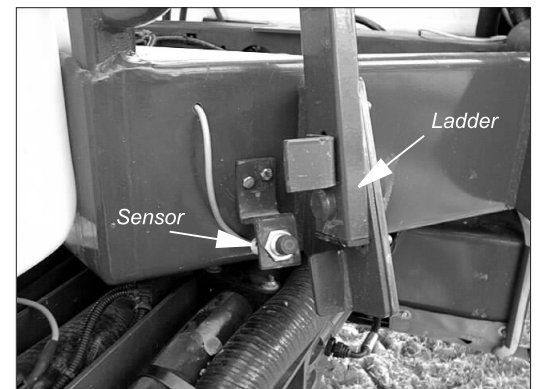

Boom sensor

If the boom is not completely unfolded, NOVA Track module automatically goes to manual mode and the centre position LED at the knob will flash. Drawbar movements will be possible in manual mode.



Warning: When folding the boom to transport position, the drawbar MUST be in centre position. When the boom is in transport position, the NOVA Track MUST be disabled.

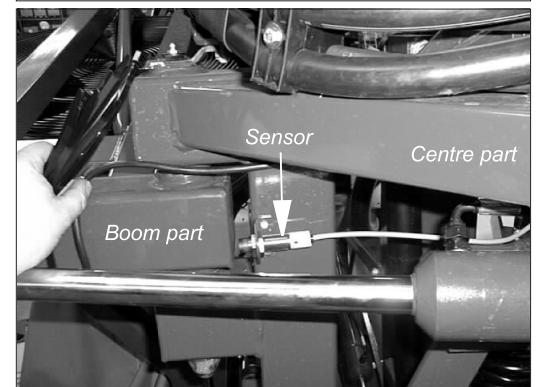

5. Functions description

Calibration

Before initial use of the NOVA Track, a calibration procedure must be carried out:

Centre position:

Turn  to straighten drawbar and sprayer. Press  and  at same time, thereafter press  within 3 seconds.

Final stops left and right:

Turn  until left stop is reached, press  and  at the same time, thereafter press  within 3 seconds.













Turn  until right stop is reached, press  and  at the same time, thereafter press  within 3 seconds.

Sensitivity of the proportional valve:

Press  and  at the same time, thereafter press  until the drawbar has made a little move to left and right.









Setting the Dead Zone value

This determines how large play in angle is being accepted, before the NOVA Track reacts.





1. Press  to go to the Set-up menu.
2. Select the  with the  keys.
3. Press , the current symbol is now flashing.
4. By pressing the  and  keys choose the  symbol.
5. Press  again, the current value will flash.
6. Set desired value by means of the  and  keys (Typical range is 0.5 to 2.0 degrees).
7. Press  to store the new value.
8. With ,  you are back in the Result menu.

Setting the Track Control response value

This determines how much response the NOVA Track should give.













1. Press  to go to the Set-up menu.
2. Select the  with the  keys.
3. Press , the current symbol is now flashing.
4. By pressing the  and  keys choose the  symbol.
5. Press  again, the current value will flash.

5. Functions description

- Set desired value by means of the  and  keys (Typical range is 2.3 to 3.5).
- Press  to store the new value.
- With ,  you are back in the Result menu.

Setting the distance from tractor rear axle to drawbar pin

Larger values than factual will result in smaller reactions, opposite to smaller values which gives greater reactions.

- Measure distance in centimetre from centre of tractor rear axle to drawbar pin.
- Press  to go to the Set-up menu.
- Select the  with the  keys.
- Press , the current symbol is now flashing.
- By pressing the  and  keys choose the  symbol.
- Press  again, the current value will flash.
- Set desired value by means of the  and  keys.
- Press  to store the new value.
- With ,  you are back in the Result menu.

Examples on different settings are given in the box below.

	Driving behavior		Dead Zone Value	Tractor Control Response Value	Track function	Reaction on sprayer/boom
Vegetables	Slow speed	Normal turns	0.5 - 1.2	2.3	Very high precision.	Smooth movements. Boom unaffected
		Sharp turns	0.8 - 1.5	2.8	High precision.	More abrupt movements on sprayer. Some movement on boom.
Cereals	High speed	Normal turns	1.8	2.8	High precision.	More abrupt movements on sprayer. Some movement on boom.
		Sharp turns	1.8	2.8	Fair precision.	Sprayer and boom moving FAST. Risk of sprayer tipping over!

Chart 100 GB

Troubleshooting

Problem	Solution	Consequence
Precision poor:		
Sprayer over-compensates	Increase Tractor Control Response value	More abrupt movements
Sprayer cuts corners	Decrease Tractor Control Response value	Less abrupt movements
	Tractor length needs re-adjustment.	Fixes problem
Sprayer oscillates (not stable in curves, and/or when going straight)	Increase dead zone (steps of 0.3)	Some precision lost
	Decrease Tractor Control Response value (steps of 0.3)	Very fast/sharp turns not possible
	Excessive play in drawbar pin. Fit bushes to take up the slack.	

Chart 101 GB

6. Initial operation

6. Initial operation

Connecting the sprayer

When the sprayer is coupled to the tractor the electrical connection can be carried out. To do this simply connect the LBS plug to the corresponding socket on the tractor.

Switch on

When the sprayer is connected, the NOVA system can be switched on. For this push the  button on the NOVA Set 4500. The Result menu on NOVA Display 4100 will light up and the screen will show the below.

Once the standard readout appears on the screen, the NOVA Set 4500 and NOVA Display 4100 are ready for operation. If you have additional modules these must be switched on separately. The indicator LED in the  button shows the current state of the module.

Example:



Application rate

The application rate must be set to the required value before spraying can be started in automatic mode.

Push the  key to change from the Result menu to the Set-up menu.

The symbol  will flash.

The current application value in the 4th row of the screen is shown.

Press  again. The application rate will now flash.

Adjust the value to the preferred rate with the  and  keys. Press  again and a “bip” indicates that the value is stored.

Press  to go back to the Result menu.







Before commencing spraying, check if the  button on the NOVA Set 4500 is switched off. Otherwise the sprayer will work in manual mode and the programmed value can not be reached.

When dosage changes during spraying, then a dosage alarm will show the deviation in percentage from the programmed value. This is displayed in the 4th row of the screen.

Reset registers

The area sprayed, spraying hours, covered distance and sprayed amount counters should be reset before beginning a new field.

To re-set the current register, select , then press  and  at the same time.

Then , ,  and  will light up at same time. Release and press  and  again within 3 seconds, and register will be cleared now.

More information about registers is described in Chapter 7 ‘Registers’.

6. Initial operation

Boom and section controls

If available the booms can be unfolded with the NOVA Hydraulic 4600 module. To operate, refer to Chapter 5 'Add on Modules'.

When unfolded the boom height, tilt and slant can be operated with the NOVA Grip.

Refer to Chapter 5 "HARDI NOVA Grip 4510".

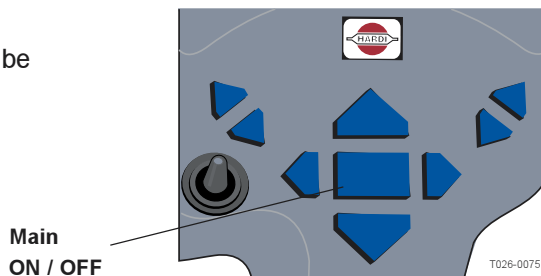

The sections need to be pre-selected. Select them using the switches on the NOVA Grip.

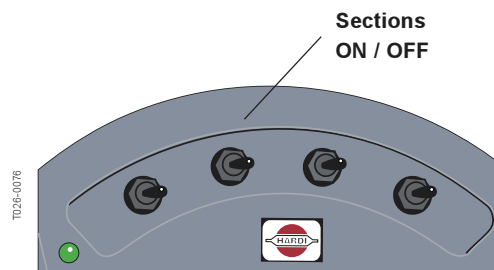

Sections pre-selected can be seen on the first row of the NOVA Display 4100. This looks as follows:



The picture shows 4 pre-selected sections that are not spraying.

The sprayer is switched ON and OFF with the Main valve key on the NOVA Grip. When pressed once, it is switched on. Pressing it a second time switches off the sprayer again. If the sections are active, spraying can be seen on the display. The pre-selected sections are displayed with a spraying cone under each nozzle. This looks as follows:



To prevent over- or under-dosage when the sprayer is being switched on, it is recommended to switch off and on at the same speed.

7. Set-up

7. Basic set-up

Registers

It is possible to use up to 16 different registers. Each register represents a set of the four counters:

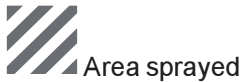

Area sprayed



Amount sprayed



Distance covered











Spraying hours

A register is selected in the following way:





Attention! When you select another register, the counting of the current register will be stopped and the new one will be started with its current values.

1. Press  in the Result menu to switch to the Tuning menu.
2. Select  with the  keys. The current register number is shown in the 4th row.
3. Press  to enter the selection mode. The value is flashing now.
4. Adjust the number with the  and  keys to the one you want.
5. Press  to select this register.
6. Press  to go back to the Result menu.

Start/Stop/Save counting

Start: The counting is started automatically when the register is selected in the calibration menu.







Reset: All four counters of the current register will be reset by pressing  and  in the Result menu at the same time.

Stop: Counting will be stopped for the current register, when another register is selected.

Save: The current counters are saved to the permanent memory every 60 seconds. To prevent loss of up to the last 60 seconds, the HARDI NOVA Set 4500 should be switched off before switching off the power supply.

Total register counter reset

To re-set the total register, select , then press  and  at the same time.

Then , ,  and  will light up at same time. Release and press  and  again within 3 seconds, and register will be cleared now.

Display counters

The counters of the current register can easily be shown by selecting the corresponding symbols from the Result menu. The counter value will then be shown in the 4th row of the display.

If the values of an other register needs to be shown, the register must be selected first. When selected, the values can be shown in the Result menu.

7. Set-up

Flowmeter calibration

Before initial operation the flow sensor must be calibrated. The number of impulses per unit may also change during lifetime of a flowmeter. It is recommended to carry out re-calibration at least once during the spraying season. For this purpose only clean water should be used. There are 3 ways to adjust the impulses per unit.

- A. Theoretical calibration – Direct setting of Pulses Per Unit (PPU).
- B. Practical calibration – Nozzle method.
- C. Practical calibration – Tank method.

For the sake of accuracy, the practical methods are preferred.

Theoretical calibration – Direct setting of Pulses Per Unit (PPU).













To change the flow constant theoretically:

During theoretical flow calibration the number of pulses per unit are shown on the display. For example [120.00] indicates the number of pulses which theoretically come from the flow transducer when 1 litre of liquid passed through.

Approximate PPU values for different flow housings are as follows:

Housing	Identification	Flow range l/min	Value PPU value	Orifice mm
S67	One groove	5 – 150	120.0	13.5
S67	No groove	10 – 300	60.0	20.0
S67	Two grooves	35 – 600	16.0	36.0

Input of a known number of impulses:

1. Press  to change to the Set-up menu.
2. Select the  symbol with the  keys.
3. A symbol of this menu will be shown in the 4th row of the screen.
4. Press  again, the current symbol is now flashing.
5. By pressing the  and  keys and choose .
6. Press  again, the current value is flashing.
7. The current value can be adjusted according to the known PPU value by pressing the  and .
8. Press  to store the new value. Note this in Chapter 12, "Records".
9. With ,  you are back in the Result menu.

7. Set-up

Practical calibration – Nozzle method.



Calibration is done with clean water and the actual flow rate is not changed during the calibration.

During practical Nozzle calibration the individual nozzle output on the display is compared to the current individual nozzle output. The output displayed is corrected to read the current output. An approximate flow constant value must be entered before calibrating with the Nozzle method.



















Note: The Tank calibration method is more time consuming, but is more accurate than the Nozzle method. When changing to nozzles with more than a 100% increase or decrease in output, it is recommended to recalibrate the flow transducer.

For accurate calibration please be sure that the right values are entered in the following menus:

- Total boom length is entered in the menu 
- Number of nozzles per section is entered in the menu 

Nozzle method:















1. Fill up the tank with clean water.
2. Press  to change to the Set-up menu.
3. Select the  symbol with the  keys.
4. A symbol of this menu will be shown in the 4th row of the screen.
5. Press  again, the current symbol is now flashing.
6. By pressing the  and  keys choose the  symbol.
7. Press  again, the current value is flashing.
8. Press  and  at the same time; "0" is flashing in the 4th row of the screen.
9. Open all boom sections.
10. Turn the main ON/OFF valve on.
11. The display unit will then show the individual nozzle output per minute.
12. Using a HARDI calibration jug, check the actual nozzle output per minute. It is recommended that an average of several nozzles has to be taken.
13. Press  again. The value will flash at a slower rate.
14. Set the value on the display by pressing the  and  keys to set the average measured output.
15. Press  to store the new value.
16. With ,  you are back in the Result menu.
17. Turn the main ON/OFF valve back to off. Note the new value in Chapter 12 "Records".

7. Set-up

Practical calibration – Tank method.

Calibration is done with clean water.

Tank method:

1. Fill up the tank with clean water.
2. Determine the total weight of the sprayer.
3. Press  to change to the Set-up menu.
4. Select the  symbol with the  keys.
5. A symbol of this menu will be shown in the 4th row of the screen.
6. Press  again, the current symbol is now flashing.
7. By pressing the  and  keys choose the  symbol.
8. Press  again, the current PPU value will flash.
9. Press  and  at the same time to start the calibration mode. “0” will be displayed.
10. Make sure all boom sections are turned on and switch on the main value. Spray out at least 50% of the tank contents. During this time the 4th row of the screen will show the registered pulses.
11. Switch the main valve off. Counting will stop.
12. Press  to leave the counter. Again “0” will be displayed.
13. Adjust the value in the screen to the volume sprayed out (weight difference).
14. Press  to recalculate.
15. The new number of impulses will now flash on the screen.
16. Press  to store the new value.
17. With ,  you are back in the Result menu. Note the new value in Chapter 12 “Records”.

7. Set-up

Circulation Semi-continue System (with two flowmeters)

Flow regulation measurement is done by two flowmeters (single flowmeter in other systems). HARDI NOVA regulates the regulation valve automatically based on a calculation of difference between flow in flowmeters and requested spraying flow rate. To do this, the system has to be calibrated so flowmeter 1 and 2 have approximately the same PPU value.

The flowmeter in out-going end from tank (F1), is calibrated as usual; see "Flowmeter calibration". The return flowmeter (F2) is calibrated automatically when activating "Calibration" from the separate calibration menu.











Calibration procedure

Step 1:

Return hose to tank must be closed manually (regulation valve closed) and all boom sections must be open. Calibration starts with flowmeter F1 and should be calibrated with tank method or nozzle method. See separate "Flowmeter calibration" section for details on how to do this.

Step 2:

Before calibrating return flowmeter (F2), completely open regulation valve and close all boom sections.

1. Go to the  option in the  menu.
2. Press  and current PPU value is shown.
3. Now there is two possibilities (B-option recommended):
 - A. Press  and  to change value manually and store it by pressing  again.
 - B.
 - I. Press  and  in same time, then display shows actual flow through out-going flowmeter (F1).
 - II. Press  and the new PPU value for return flowmeter (F2) is calculated.
 - III. Press  again to store value.







7. Set-up

HARDI NOVA can be connected to the HARDI FILLMETER or tank contents sensor (e.g. Tank Control). HARDI NOVA can also automatically calculate the remaining amount of liquid in spray tank if user has manually set a tank contents value when tank has been filled.

HARDI FILLMETER is a stand-alone kit for tank filling measurement, but can be controlled by the HARDI NOVA.















Set-up for tank contents or HARDI FILLMETER or Tank Control

If there is no filling flowmeter or tank contents sensor, use this method.

1. Go to the  option in the  menu.
2. Press  and maximum tank size or last entered volume will be shown.
3. Press  and  to change the value manually and store it by pressing  again.
4. Press  to leave the submenu.







Calibration procedure for HARDI FILLMETER

This method is similar to the Tank Method calibrating for flowmeter. See “Practical Calibration, Tank Method”.





1. When calibrating then go to the  option in the  menu.
2. Press  and display will show the current PPU value.
3. Now there is two possibilities (option B recommended):
 - A. I. Press  and  to change the value manually and store it by pressing  again.
II. Press  to leave the submenu.
 - B. I. Press  and  in same time, then display shows actual flow through flow sensor.
II. Press  and the calculated filled volume will be displayed.
III. Press  and  to adjust to actual volume.
IV. Press  again to store value.
V. Press  to leave the submenu.



Filling procedure

This option is for sprayers fitted with HARDI FILLMETER or Tank Control.

1. Go to the  option in the  menu.
2. Press  and last fill level or maximum tank size is shown.
3. Press  and  to change the value manually and store it by pressing  again.

Filling:

4. After setting the desired filling value, HARDI NOVA is back in the  option.
5. Press  and the desired fill level is shown up again.
6. Press  and  in same time. This will open filling valve and current tank level is displayed during filling. When desired tank level is reached then HARDI NOVA automatically closes the valve again.
7. Press  to leave the submenu.

Note that, when  or  is pressed during filling process, the valve will close and display shows the desired fill value setting.

7. Set-up

Speed calibration

Speed calibration

Before the initial operation of the sprayer the active speed sensor must be selected and calibrated. For this you need to know, which of your system's sensors is to be used. You can select from 3 speed sensors:



Each of these sensors can be selected and calibrated separately. The following describes how to set the number of impulses, calibrate the sensors and select the current used sensor.

Theoretical speed calibration or selection of active sensor

With this method it is possible to enter a known number of impulses (PPU) for a sensor or select a speed sensor if more than one can be selected.

1. Press to change to the Set-up menu.
2. Select the symbol with the keys.
3. A symbol of the current menu will be shown in the 4th row of the screen.
4. Press again. The symbol is now flashing.
5. By pressing the and keys choose the or the or the symbol.
6. Press again. The current value is flashing.
7. The current value can be adjusted according to the known PPU value by pressing the and .
8. Press to store the new value.
9. With , you are back in the Result menu.

Practical speed calibration



















Note: The practical speed calibration method is more time consuming, but more accurate than the theoretical speed calibration method.

Follow the described steps to calibrate a speed sensor.













1. Measure and mark a distance of 100 meters or 300 feet on a field (the unit depends on the current country setting of the HARDI NOVA).
2. Drive the tractor to the beginning of this line.

7. Set-up

3. Press  to change to the Set-up menu.
4. Select the  symbol with the  keys.
5. A symbol of the current menu will be shown in the 4th row of the screen.
6. Press  again. The symbol is now flashing.
7. By pressing the  and  keys choose the relevant symbol  or  or .
8. Press  again. The current PPU value will flash.
9. Press  and  at the same time to start the calibration mode. "0" will be displayed.
10. Drive the distance. The value in the display will increase.
11. Press  to stop the calibration mode. The current value is displayed flashing.
12. Press  again to store the value.
13. With ,  you are back in the Result menu.

Set Pulses Per Unit (PPU) PTO

This function can only be utilized with Agrocom or MF FieldStar terminals. To measure the PTO speed, it is necessary to know how many impulses are measured for one revolution.

1. Press  to change to the Set-up menu.
2. Select the  symbol with the  keys.
3. A symbol will be shown in the 4th row.
4. Press  again. The symbol is now flashing.
5. By pressing the  and  keys choose the  symbol.
6. Press  again. The current value is flashing
7. The current value can be adjusted according to the known PPU value by pressing the  and .
8. Press  to store the new value.
9. With ,  you are back in the Result menu.

7. Set-up

Setting of AUTO ON/OFF speed

With the AUTO ON/OFF speed, an automatic control of the Main ON/OFF is possible. The AUTO ON/OFF can be set in the  menu.

Once set, and the Main ON/OFF is activated, the valve will function automatically.















If the speed is less than the defined speed value, the Main ON/OFF automatically goes to off position. (No spray solution is coming out of the nozzles).

When AUTO ON/OFF automatically turns OFF then the  will flash.

If the speed is greater than the defined speed, the Main ON/OFF automatically goes to on. (Spray solution is coming out of the nozzles). Section symbols in display will stop flashing again.

If the value of AUTO ON/OFF speed is set to "0.0", the automatic control of the Main ON/OFF is disabled.









To set the AUTO ON/OFF speed:

1. Press  to change to the Set-up menu.
2. Select the  symbol with the  keys.
3. A symbol of the current menu will be shown in the 4th row of the screen.
4. Press . The current symbol is now flashing.
5. Select the  symbol with the  and  keys.
6. Press  again. The  current speed value is flashing now.
7. The current value can be adjusted to the new wanted value by pressing the  and  keys.
8. Press  to store the new value.
9. With ,  you are back in the Result menu.

7. Set-up













Adjust boom width

The boom width of the sprayer is needed to calculate the area worked on and the current application rate. This must be set before the first use of the sprayer.

1. Press  to enter the Set-up menu.
2. Select the symbol  with the  keys.
3. Press ; the value of the boom width will flash.
4. Adjust the value with the  and  keys.
5. Press  to store the value.
6. With ,  you are back in the Result menu.

Number of nozzles per section













To secure an accurate regulation when sections are switched off, the nozzles per section must be known to the sprayer control unit. Follow the next steps to adjust the number of nozzles for each section.

1. Press  in the result menu to enter the tuning menu.
2. Select the symbol  with the  keys.
3. Press ; the value on the right in the display will flash. This is the section number from the left side.
4. Select the section number with the  and  keys
5. Press  to enter the number of nozzles (value on the left)
6. Adjust the number of nozzles with the  and  keys
7. Press  to store the value.
8. Repeat steps for all sections. Note this in Chapter 12 "Records".
9. With ,  you are back in the Result menu.

7. Set-up

Regulation constant adjustment

The regulation constant adjusts the regulation speed of the pressure regulation value. A high value will cause a fast reaction, a low value a slow reaction. If the value is too high, the application rate will not be stable. If the value is low, the regulation frequency will be slow.



1. Press  to select Set-up menu.
2. Select the symbol  with the  keys.
3. A symbol will be shown in the 4th row of the display.
4. Select the  symbol with the  and  keys.
5. Press ; the value of the constant will flash.
6. Adjust the value with the  and  keys. (Normally between 30 and 40).
7. Press  to store the value.
8. With ,  you are back in the Result menu.

7. Set-up

Select units (US or Metric)

The units to be displayed in the 2nd and the 3rd row (l/ha or gal/ac and km/h or mph) can be selected by holding down the  key on the HARDI NOVA Set 4500 unit and then switching it on. The l/ha in the 2nd row will start flashing.

The l/ha or gal/ac can be selected by using the  and  keys and stored by using the  key. After the 2nd row has been selected and stored the km/h in the 3rd row will start flashing.

The km/h or mph can be selected by using the  and  keys and stored by using the  key. This selection is valid for all input or output values of the entire system.

7. Set-up

Data output

Print menu

With this function it is possible to print out information stored in the HARDI NOVA. To make this possible it is required that the additional NOVA printer-module is connected via the RS232-plug.

You can select to print out specific register or print out all data stored in the NOVA.

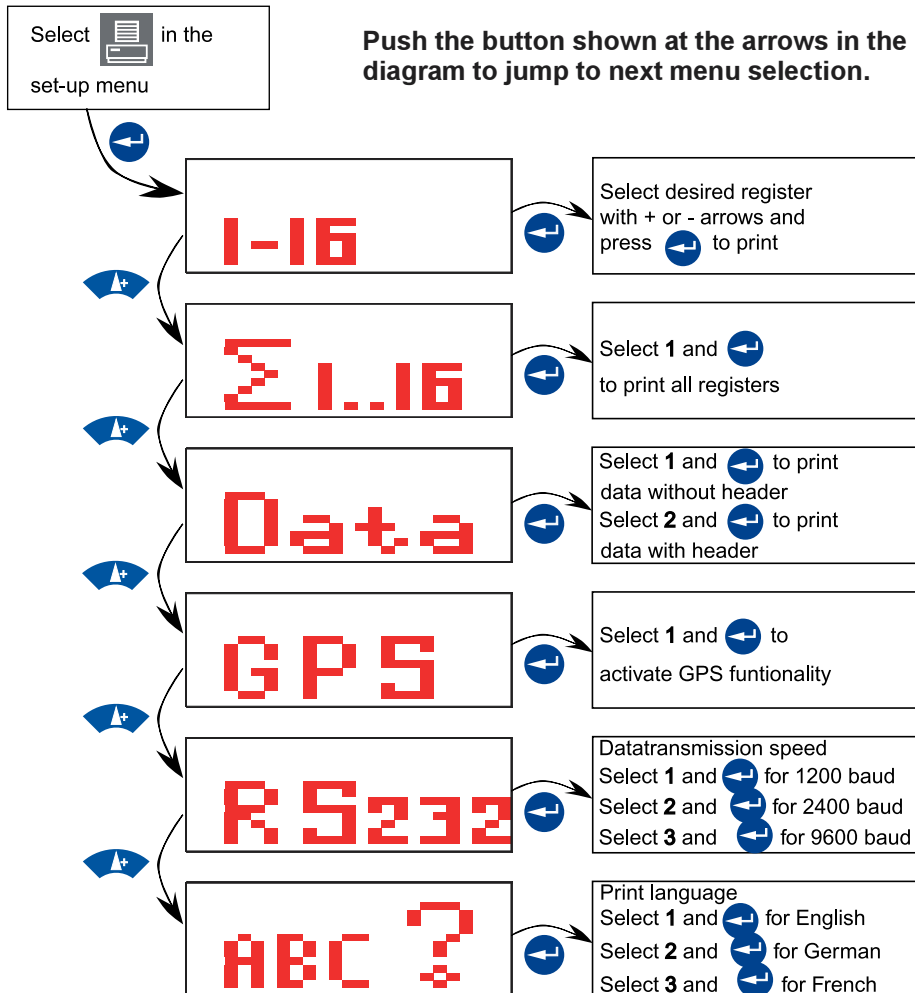

When printing, the ON/OFF buttons are sequentially flashing on all modules.

Data dump

Via the RS232 port, it is possible to dump the register data from HARDI NOVA to a PC. This is done via a terminal program like e.g. the "hyperterminal" that comes with most Windows® installations. A cable and power supply kit is necessary.

Procedure:

1. Bring all HARDI NOVA modules to the PC and connect cables and turn power on.
2. Open (e.g.) hyperterminal and make connection to HARDI NOVA. (PC-setup: baud rate=1200/2400/9600; Data bits= 8; Parity= none; Stop bits= 1; Flow control= none).
3. Go to the **Data** menu as shown in diagram above.
4. Select whether data is dumped with or without header and press . Dumped data will scroll down through the hyperterminal screen and ON/OFF buttons on the NOVA modules will flash to indicate ongoing dumping.
5. Save dumped data on the PC.

Note: To time and date stamp the data, the printer module must be connected to HARDI NOVA when spraying.











7. Set-up

Register Printout

If an external printer is connected to the RS-232 output on the display module, a printout of up to 16 registers each with it's 4 sub-counters can be done. See example.

The additional printer for the HARDI NOVA has a built-in real time clock. With the printer mounted, register data can be printed with information on starting and ending time and day of each register use (Time/Date stamp).

Before starting the printout make sure the printer is connected to the NOVA Display module and switched on.

1. Press  to change to the Set-up menu.
2. Select the  symbol with the  keys.
3. The 4th row of the display shows the  register icon.
4. Press  and current register will be displayed. Press  and the current register number is now flashing.
5. By pressing the  and  keys a single register can be selected to print. (Values from 1 to 16).
To print out all registers (64 values)  must be chosen in the selection.
6. Press  again and the current register is send to the printer for printout.

HARDI NOVA	
Spraycom ID	: 101101
Register number	: 1
Area	: 15.86 ha
Application rate	: 272.85 l/ha
Volume applied	: 4330 l
Start date	: 11:11:01
Start time	: 11:45
Stop date	: 08:01:02
Stop time	: 14:23
Time used	: 01:33 h
Work rate	: 10.1 ha/h
Print date	: 08:01:02
Print line	: 14:25

Use with site specific application signal (GPS)

HARDI NOVA can be used for site specific application (under the common name GPS). Connect the HARDI NOVA to an external GPS instrument at the RS-232 port in the display module.

When connected it is necessary to find the  option in the  menu in HARDI NOVA and enable it.

The  icon will light up permanently to indicate that the external GPS instrument has taken over control with the set-up functions.

8. Storage

8. Storage

The HARDI NOVA does not need any maintenance but it should be protected from moisture. Remove it if the tractor has no cabin. During winter it should be stored in a dry room at temperatures above 0° C / 32° F.

If the sprayer is not connected to the tractor, the LBS/ISO socket on the tractor and the plug on the sprayer should be covered with the protective cap.



Attention: Be careful when cleaning the sprayer. Do not use a high pressure cleaner near the control unit and the connectors.

9. Quick guide

9. Quick guide

TWIN module

Fan speed

ON/OFF

Air angle

Fan speed and air angle: Preset 1 Preset 2

Store setting on a preset button:
Adjust fan speed and air angle with potentiometers, press **1** or **2** three seconds.

Recall preset:
Press **1** or **2** on TWIN module or one of the preset buttons on the back of NOVA Grip.

Track module

Calibration key

ON/OFF

Manual / Auto toggle switch

Centre position Manual control Crab walking

Calibration

Centre position: Turn to straighten drawbar and sprayer. Press **CAL** and at the same time, thereafter press **CAL** within 3 seconds.

Final stops:

Turn until left stop is reached, press **CAL** and at the same time, thereafter press **CAL** within 3 seconds.

Turn until right stop is reached, press **CAL** and at the same time, thereafter press **CAL** within 3 seconds.

Sensitivity: Press and **CAL** at the same time, thereafter press **CAL** until the drawbar has made a little move to left and right.



NOVA Quick guide

NOVA Grip

Indicator LED

- Off = no power
- Flashing = no communication
- On = ready to operate

Boom sections ON/OFF

Boom raise

Boom tilt right
raise
lower

Boom slant right down

Main ON/OFF

Boom lower

Boom tilt left
raise
lower

Boom slant left down

Foam marker control

OFF
Increase
Decrease
Left on
Right on

Recall TWIN preset 1
Recall TWIN preset 2

978107 GB 02 01

9. Quick guide

Menu basics

The menu is divided in 2 sections. The Result menu (left 3 rows), which is used while spraying, and the Set-up menu (right 2 rows).

When the system is turned on, the Result part is active.

To enter the Set-up menu press .

To go back to Result menu, press .

Navigating: Use  to move from one menu to another.

The bottom screen line will show the menu value. The most common menus can be stored in the preset **1 2 3 4**:

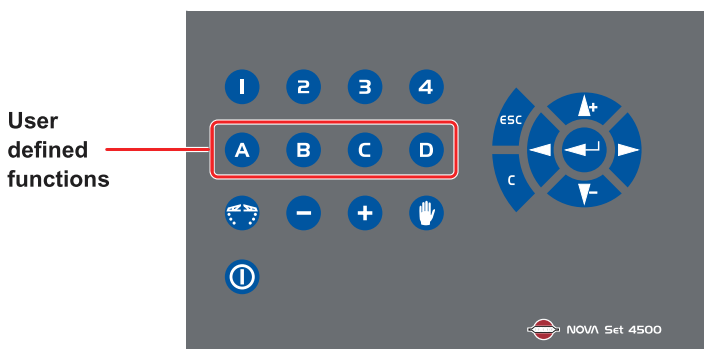
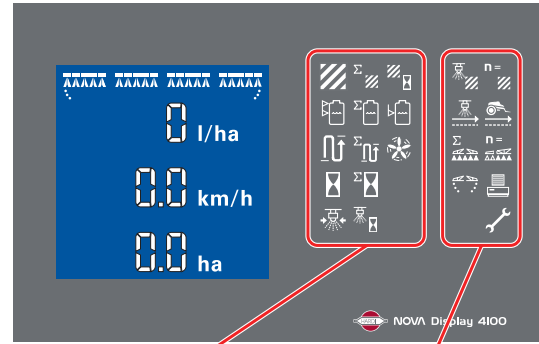

Find the menu with the navigation keys and press and hold the selected button for 3 seconds. Recall menu: Push the selected button.



Result menu	Set-up menu
Sprayed area (re-settable)	Set application rate
Sprayed area sum	Set total boom width
Area worked per hour	Set nozzles per section
Spraying hours (re-settable)	Select active register
Spraying hours sum	Select flow calibration
Distance travelled (re-settable)	Select speed calibration
Distance travelled sum	Set foam marker functions
Flow rate	Set print / data / GPS functions
Spray pressure	Set service
TWIN fan revs.	
Sprayed volume (re-settable)	
Spray volume in tank	
Sprayed volume sum	

Basic operation:

Set application rate:



Press , select  icon is blinking. Press .

Adjust value with  and  keys. Press  .

Adjust application rate in 10% steps while spraying:

Press  to increase or  to decrease.

Manual spraying:

Press . Adjust pressure with  and  keys.

Press  again for automatic.

Current register:

Shown in:



Hydraulic module

Open pendulum

LED = "ON" when locked.

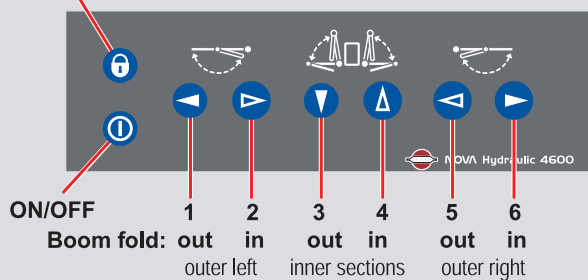

Single-side inner fold e.g. HARDI ALPHA

Left side: Fold out, push buttons 3 and 1. Fold in, push buttons 3 and 2.

Right side: Fold out, push buttons 4 and 6. Fold in, push buttons 4 and 5.

Alarm codes

- Alarm 1: Cannot reach application rate
- Alarm 2: Max. pressure limit exceeded
- Alarm 3: Min. pressure rate exceeded
- Alarm 4: Min. tank contents exceeded
- Alarm 8: Wrong final stops. Calibrate NOVA Track
- Alarm 9: Injection defective
- Alarm 25: Incorrect gyroscope assembly
- Alarm 26: Potentiometer measurement inverted
- Alarm 27: Calibration of NOVA Track necessary
- Alarm 28: Check NOVA Track parameter
- Alarm 29: NOVA Track drawbar sensor is defect
- Alarm 30: NOVA Track gyroscope is defect
- Alarm 31: NOVA Track slope sensor is defect

10. Fault finding

10. Fault finding

For emergency operation of the sprayer, refer to the operating manual of the sprayer. All possible emergency operations will be described there.

Alarm numbers and their meaning

Alert No.	Description	Remedy
1	Cannot reach application rate	Flow rate too high > raise speed. Flow rate too low > reduce speed. Application rate jumps around selected value > decrease regulation constant. Application rate changes slowly > increase regulation constant.
2	Max. pressure limit exceeded	Reduce speed to decrease the flow rate
3	Min. Pressure rate exceeded	Raise speed to increase the flow rate
4	Min. Tank contents exceeded	Refill the tank
8	Wrong final stops. Calibrate TRACK module	Recalibrate the TRACK module
23	Slanting sensor wrongly mounted	Check the mounting of the sensor. It must be fitted vertically to the sprayer.
24	Potentiometer wrongly mounted	Check the fitting of the potentiometer. It must be centralised when the drawbar is straight.
25	Gyroscope wrongly mounted	Check the mounting of the gyroscope at the tractor. It must be fitted vertically on the tractor. Make sure the sign 'TOP' is on the top of the sensor
26	Potentiometer measurement is inverted	Check if you followed the calibration process in the right way. If so, the potentiometer must be mounted upside down.
27	TC calibration is necessary	Redo the calibration of the TRACK module.
28	Check TC parameter	The programmed parameters of the TRACK module exceed the limits. Check the parameters.
29	TC drawbar-potentiometer is defective	Check the wires and connectors. If these are OK, change the potentiometer.
30	TC Gyroscope is defective	Check the wires and connectors. If these are OK, change the gyroscope.
31	TC slope sensor is defective	Check the wires and connectors. If these are OK, change the slope sensor.

10. Fault finding

Internal alarms

These alarms are identified by the "INT" symbol in front of the alert number:

Alarm No.	Description	Remedy
10	HARDI NOVA Set 4500 communication error.	The connection to the Display module is not OK. Check the connection.
11	HARDI NOVA Hydraulic 4600 communication error.	The module has been switched off or the connection is not OK.
12	HARDI NOVA Track 4610 communication error.	The module has been switched off or the connection is not OK.
13	HARDI NOVA TWIN 4520 communication error.	The module has been switched off or the connection is not OK.
14	HARDI NOVA Grip 4510 communication error.	NOVA Grip defective or the connection to the next module is not OK.

chart 12

10. Fault finding

Problems and solutions

<i>Failure</i>	<i>Reason</i>	<i>Repair</i>
Area is not being measured	"Boom width" or "impulses/100 m" have not been entered.	Enter the value (see ' <i>Speed sensor calibration</i> ' or ' <i>Adjust boom width</i> ').
	No impulses are coming from the speed sensor.	Check the sensor, check the cable to the sensor for damage. If necessary, replace the sensor.
The spray rate l/ha is continuously displayed at "0"	"Impulses/l" have not been entered.	Enter "Impulses/l" (see ' <i>Flow meter calibration</i> ')
	Impulses of the flow meter are not reaching the sprayer control unit.	Check wiring. Check the impeller of the flow meter - it may be stuck.
The spray rate display is not correct	The flow meter is not working properly	Check "Impulses/l" (see ' <i>Flow meter calibration</i> ').
	The area is not being determined exactly.	Check boom width and adjust if necessary. Check impulses/100 m and adjust if necessary.
The intended spray rate cannot be reached. The current quantity is below the pre-set rate	The setting motor has been wrongly poled. The rate is controlled downwards instead of upwards.	Check the control by using the +/- keys in manual mode. Change the control motor connections if necessary.
	The pump cannot deliver the required amount.	Increase PTO speed. Change to a lower gear.
	The filters are blocked.	Clean the filter.
The spray rate lies above the pre-set rate	The setting motor has been wrongly poled. The rate is controlled upwards instead of downwards.	Check the control by using the +/- keys in manual mode. Change the control motor connections if necessary.
	The return flow from the setting motor to the bin cannot take superfluous quantity.	Check the tube system. Reduce the power of the pump (lower PTO speed, higher gear).
No speed readout	Incorrect sensor location chosen	See "Speed calibration", select Sprayer, Tractor or Radar

chart 13

11. Technical specifications

11. Technical specifications

HARDI NOVA units for tractor:	
Power supply:	9.6 .. 16 V DC
Temperature range:	-20 .. +70 °C
Weight:	3.5 kg

HARDI NOVA Spraycom for sprayer:	
Power supply:	9.6 .. 16 V DC
Temperature range:	-20 .. +70 °C
Housing:	Closed aluminium box, IP65
Measurements:	250 mm x 232 mm x 77 mm (without connector)
Weight:	5.0 kg
Connections:	Thread joint for cable with LBS-connector 2 x 42 pin connector (connector A & B, counterpart lockable and with separate seals for each wire to connect actuators and sensors.
Communication protocol:	CAN BUS 2.0 B ISO 11783-2 DIN 9682-3

specifications 1 - GB

Compliance minimum

EMC	ISO 14982
Mechanical	IEC 68-2-64
	ISO 15003-6.6.1
	IEC 68-2-27
	ISO 15003-6.5.2
Climatical	IEC 68-2-14Nb/
	ISO 15003-6.2
	IEC 68-2-30/
	ISO 15003-6.4
	IEC 68-2-14Na/
	ISO 15003-6.2.2
	IEC 68-2-5/
	ISO 15003-6.11
	IEC 529/
	ISO 15003-6.8.1
Voltage	ISO 15003-6.12.1

Register update interval

Spraycom re-fresh rate: 60 sec

Display re-fresh rate: 4 sec

Default values

Volume rate:	200 l/ha	20 gal/ac
Regulation constant:	20%	20%
AUTO ON/OFF:	0.0 km/h	0.0 mph
Boom size:	21 m	120 ft
Speed PPU for radar:	10000	10000
Speed PPU for tractor:	100	100
Speed PPU for sprayer:	100	100
Flow PPU:	200	200

Compatibility with Agrocom and MF Fieldstar terminals

HARDI NOVA is compatible with the newer versions of the Agrocom and MF Fieldstar terminals. Most functions are fully compatible, others are not or only partly compatible with these terminals.

A kit is available. It contains the necessary cables and software.

Not compatible with Agrocom and MF Fieldstar

1. The increase and decrease in 10% steps of the volume rate is not possible.
2. HARDI TWIN FORCE sprayers: The HARDI NOVA TWIN module must be used for this sprayer type.

11. Technical specifications

Connectors

System connector

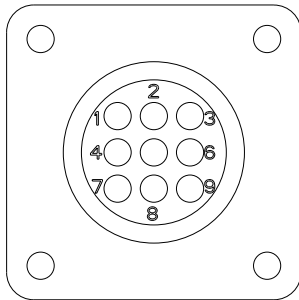

T026-0081

Pin	Function
1	---
2	CAN_L Input
3	CAN_L Output
4	CAN_H Input
5	CAN_H Output
6	CAN_EN
7	+12V
8	CAN_GND
9	GND

chart 03

Tractor signal connector

This is an 8-pin female DIN 45326 connector.

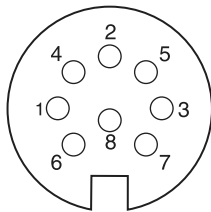

T026-0036

Pin	Function
1	Speed sensor
2	+12V
3	GND
4	PTO sensor
5	Working position
6	Radar
7	---
8	---

chart 04

Alternatively a 3-pin connector, used on single speed sensors, can be used.

Communication port connector (serial link)

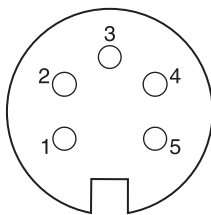

T026-0037

Pin	Function
1	CTS
2	RXD
3	RTS
4	TXD
5	GND

chart 05

Module interface connector

A 7-pin DIN connector is used here. The NOVA Set 4500 module is equipped with the female built-in version. The add-on modules have the male cable version as input and the female built in version as output. The NOVA Grip has only the male cable version.

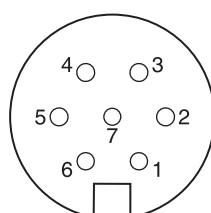

T026-0038

Pin	Function
1	CAN_L Input
2	CAN_H Input
3	Module power supply ~ 8V
4	CAN_L Output
5	CAN_H Output
6	+12V
7	GND

chart 06

11. Technical specifications

LBS socket

The LBS socket is the electrical connection to the implement.

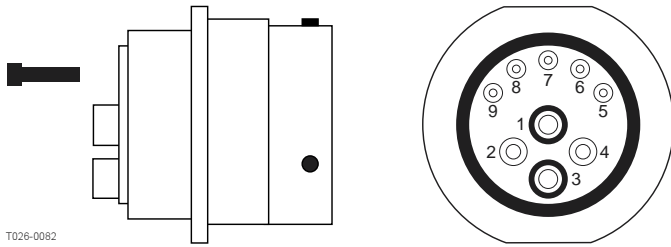

T026-0082

Pin	Contact size	Function
1	5,3 - 8,3	ground power
2	5,3 - 8,3	ground electronic
3	2,1 - 3,3	+12V power
4	2,1 - 3,3	+12V electronic
5	-	not used
6	0,8 - 1,3	CAN - enable
7	0,8 - 1,3	CAN - ground
8	0,8 - 1,3	CAN - high
9	0,8 - 1,3	CAN - low

chart 01

Terminal Connector

A 9-pin female connector is used here as stipulated for terminals in DIN 9684-2.

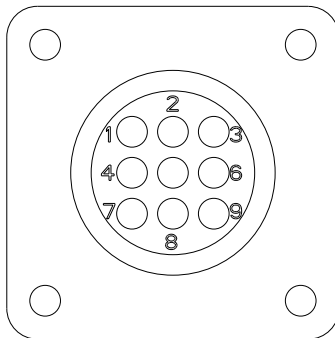

T026-0032

Pin	Function
1	---
2	CAN_L Input
3	CAN_L Output
4	CAN_H Input
5	CAN_H Output
6	CAN_EN
7	+12V
8	CAN_GND
9	GND

chart 02

12. Records

12. Records

NOVA values	Values 1	Values 2	Values 3	Values 4
Sprayer I.D.				
Volume rate:				
Regulation constant:				
Nozzle colour / I.D.				
AUTO ON/OFF:				
Speed PPU for radar:				
Speed PPU for tractor:				
Speed PPU for sprayer:				
Flow housing type:				
Flow PPU:				

Boom size:									
Number of section:	1	2	3	4	5	6	7	8	9
Number of nozzles per section:									

Notes:

13. Parts

13. Parts

HARDI NOVA SPRAYCOM

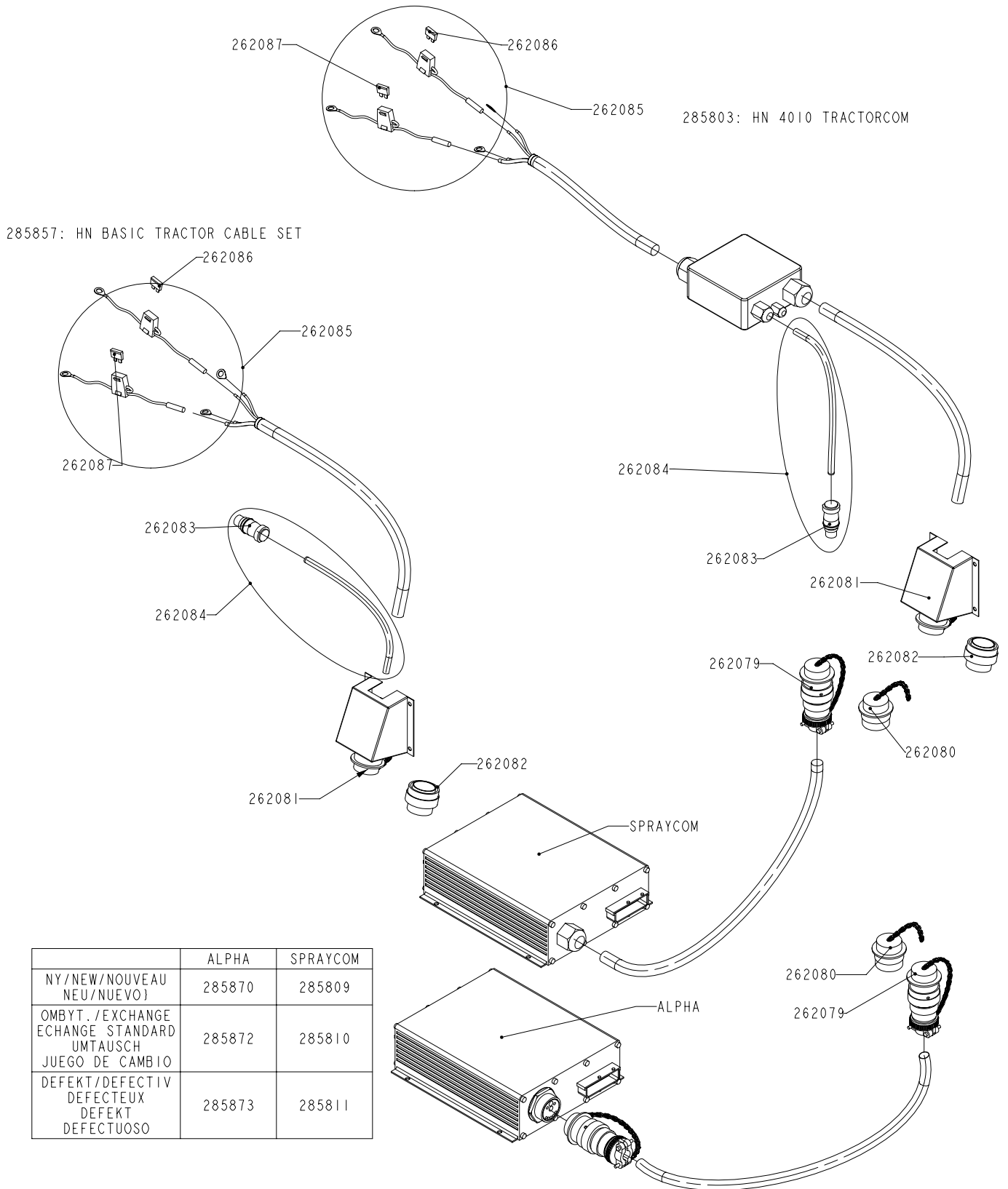

	ALPHA	SPRAYCOM
NY / NEW / NOUVEAU NEU / NUEVO }	285870	285809
OMBYT. / EXCHANGE ECHANGE STANDARD UMTAUSCH JUEGO DE CAMBIO	285872	285810
DEFEKT / DEFECTIV DEFECTUEUX DEFEKT DEFECTUOSO	285873	285811

13. Parts

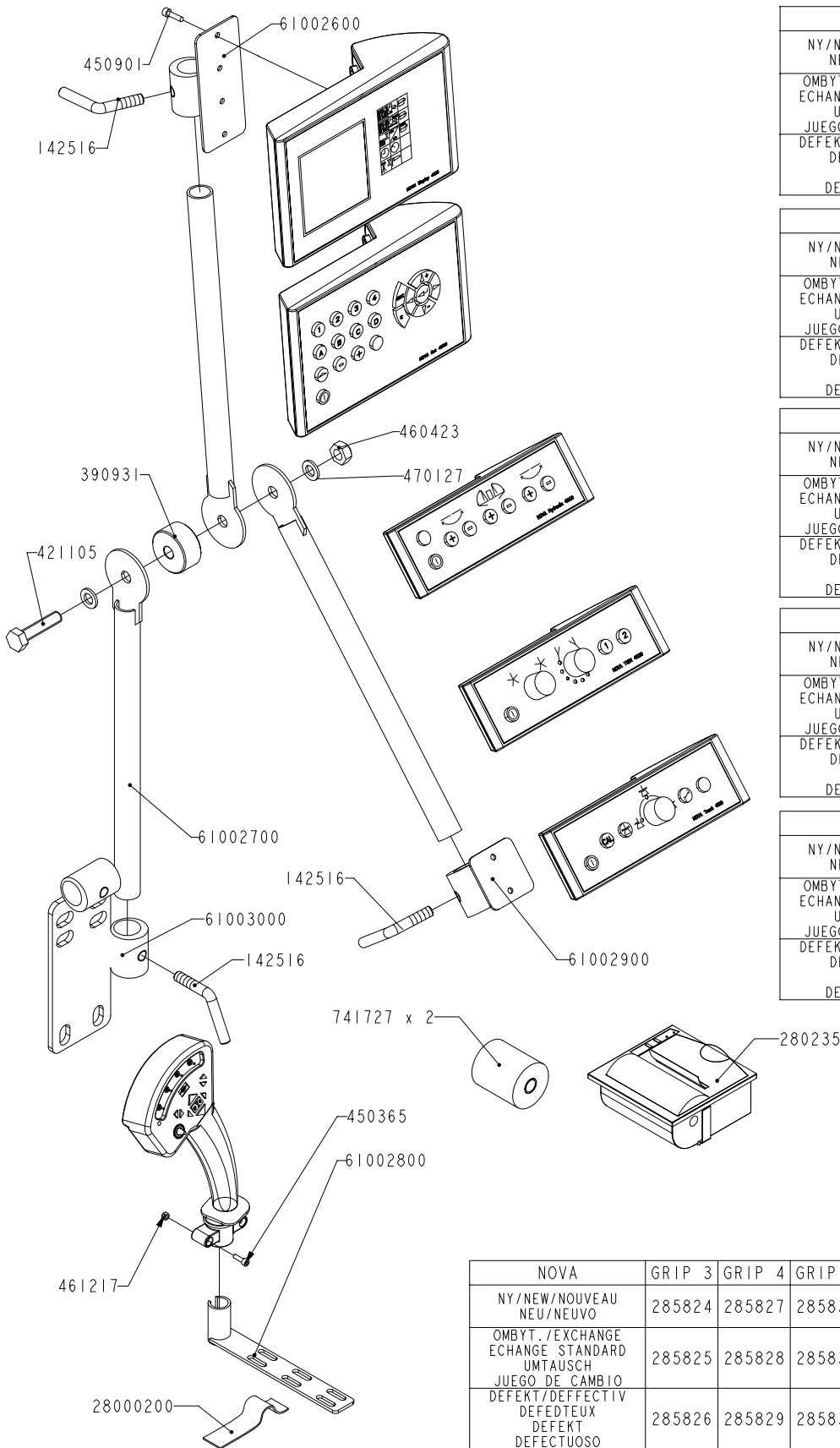

	NOVA DISPLAY 4100
NY/NEW/NOUVEAU NEU/NEUVO	285818
OMBYT./EXCHANGE ECHANGE STANDARD UMTAUSCH JUEGO DE CAMBIO	285819
DEFEKT/DEFFECTIV DEFEDTEUX DEFEKT DEFECTUOSO	285820

	NOVA SET 4500
NY/NEW/NOUVEAU NEU/NEUVO	285821
OMBYT./EXCHANGE ECHANGE STANDARD UMTAUSCH JUEGO DE CAMBIO	285822
DEFEKT/DEFFECTIV DEFEDTEUX DEFEKT DEFECTUOSO	285823

	NOVA HYDRAULIC 4600
NY/NEW/NOUVEAU NEU/NEUVO	285848
OMBYT./EXCHANGE ECHANGE STANDARD UMTAUSCH JUEGO DE CAMBIO	285849
DEFEKT/DEFFECTIV DEFEDTEUX DEFEKT DEFECTUOSO	285850

	NOVA TWIN 4520
NY/NEW/NOUVEAU NEU/NEUVO	285845
OMBYT./EXCHANGE ECHANGE STANDARD UMTAUSCH JUEGO DE CAMBIO	285846
DEFEKT/DEFFECTIV DEFEDTEUX DEFEKT DEFECTUOSO	285847

	NOVA TRACK 4610
NY/NEW/NOUVEAU NEU/NEUVO	285851
OMBYT./EXCHANGE ECHANGE STANDARD UMTAUSCH JUEGO DE CAMBIO	285852
DEFEKT/DEFFECTIV DEFEDTEUX DEFEKT DEFECTUOSO	285853

NOVA	GRIP 3	GRIP 4	GRIP 5	GRIP 6	GRIP 7	GRIP 8	GRIP 9
NY/NEW/NOUVEAU NEU/NEUVO	285824	285827	285830	285833	285836	285839	285842
OMBYT./EXCHANGE ECHANGE STANDARD UMTAUSCH JUEGO DE CAMBIO	285825	285828	285831	285834	285837	285840	285843
DEFEKT/DEFFECTIV DEFEDTEUX DEFEKT DEFECTUOSO	285826	285829	285832	285835	285838	285841	285844

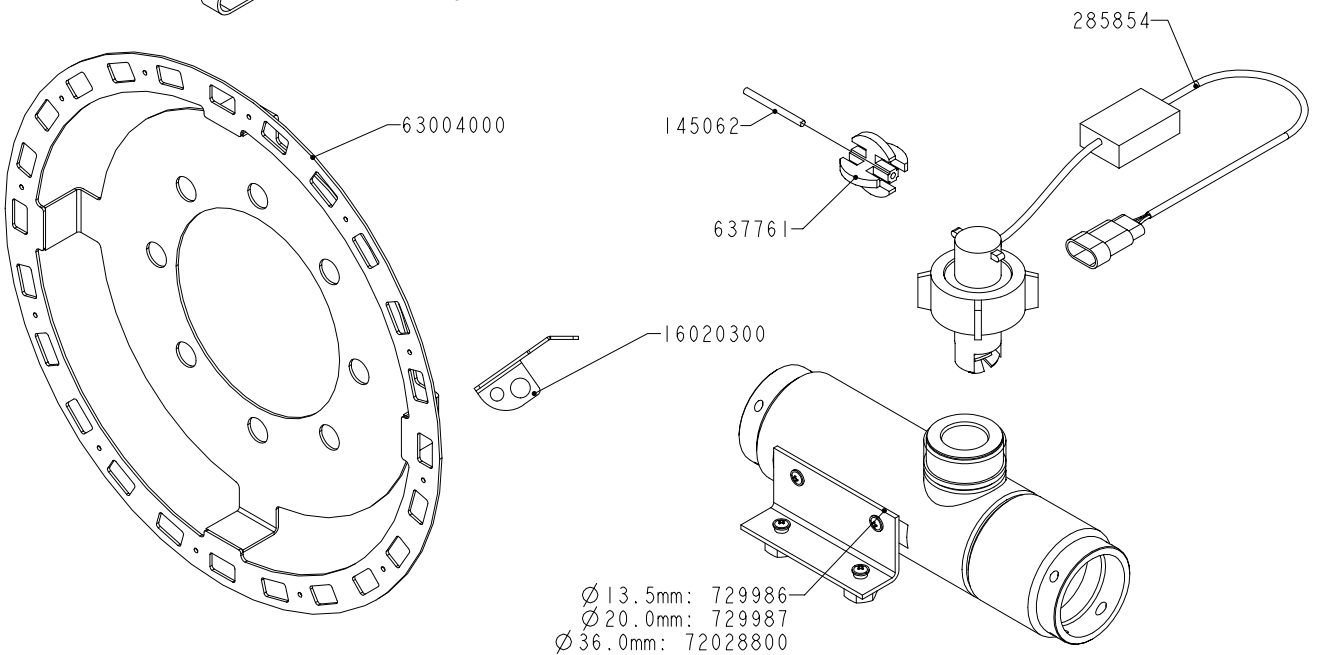
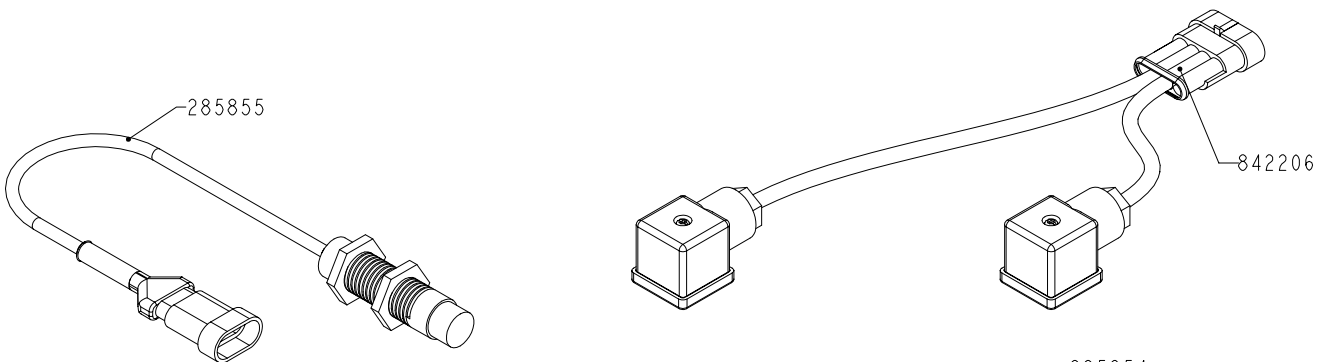
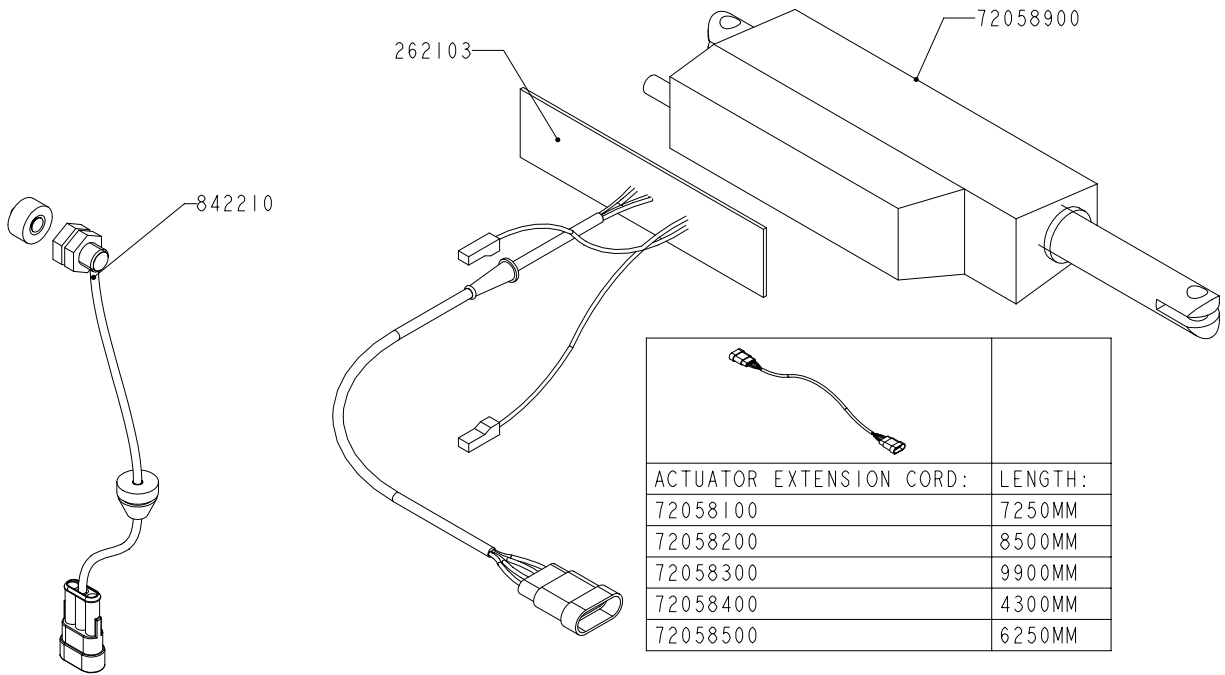

13. Parts

HARDI NOVA







13. Parts

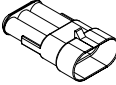

HARDI NOVA, CONNECTOR'S

 AMP Super Seal Plug					
Poles:	2 pole	3 pole	4 pole	5 pole	6 pole
No.:	262038	262039	262040	262041	262042
 Receptable contact					
Size:				0,3-0,5mm2	0,5-1,5mm2
No.:				262050	262051

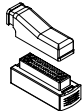
 AMP Super Seal Wire Seal				
Size:	1,4-1,7mm	1,8-2,4mm	2,6-3,3mm	Cavity Plug
Colour:	Green	Yellow	Red	Red
No.:	262052	262053	262054	262055

 AMP Super Seal Cap					
Poles:	2 pole	3 pole	4 pole	5 pole	6 pole
No.:	262043	262044	262045	262046	262047
 Tab contact					
Size:				0,3-0,5mm2	0,5-1,5mm2
No.:				262048	262049

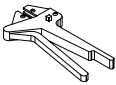
 AMP SAAB 42 Pole					
Receptable housing				262056	
Cover for Receptable housing				262059	
	AMP SAAB Receptable contact	MT2 (36/42)		JPT(6/42)	
Size:		0,5-1,0mm2	1,0-2,5mm2	0,5-1,0mm2	1,0-2,5mm2
No.:		262062	262063	262060	262061
 AMP SAAB Wire Seal					
Size:		0,5-1,0mm2	1,0-2,5mm2	Cavity Plug	
No.:		262064	262065	262075	

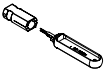
Tools				
 AMP Crimp Tool				
AMP Crimp Tool "ERGOGRIMP" (No Dies)				262067
	Dies	AMP Super Seal	AMP SAAB MT2	AMP SAAB JPT
No.:		262068	262072	262069
	AMP SAAB EXTRACTION Tool	MT2	JPT	
No.:		262073	262070	
Spare Blade:		262074	262071	

HARDI NOVA Track

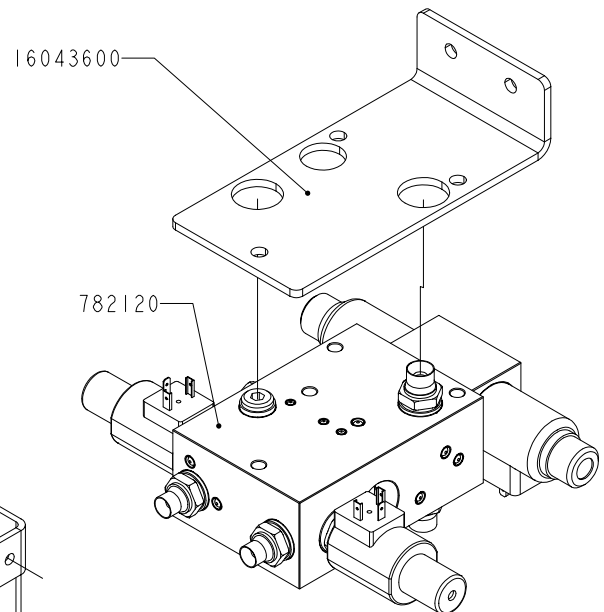
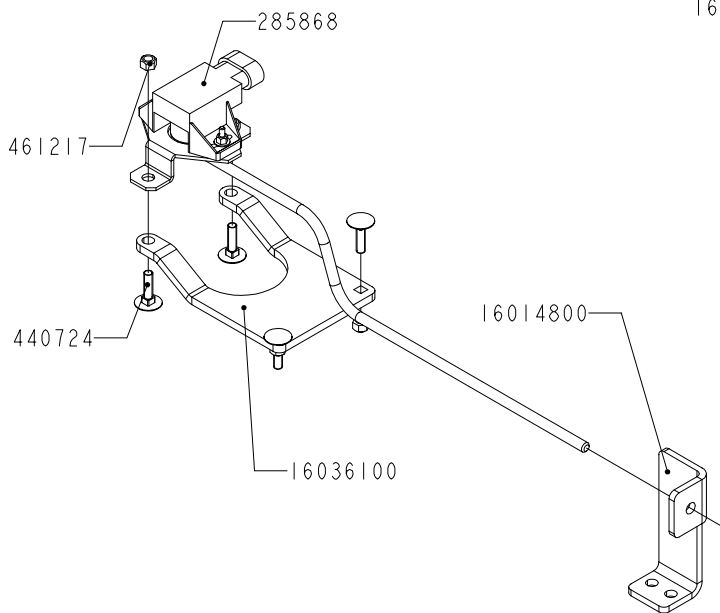
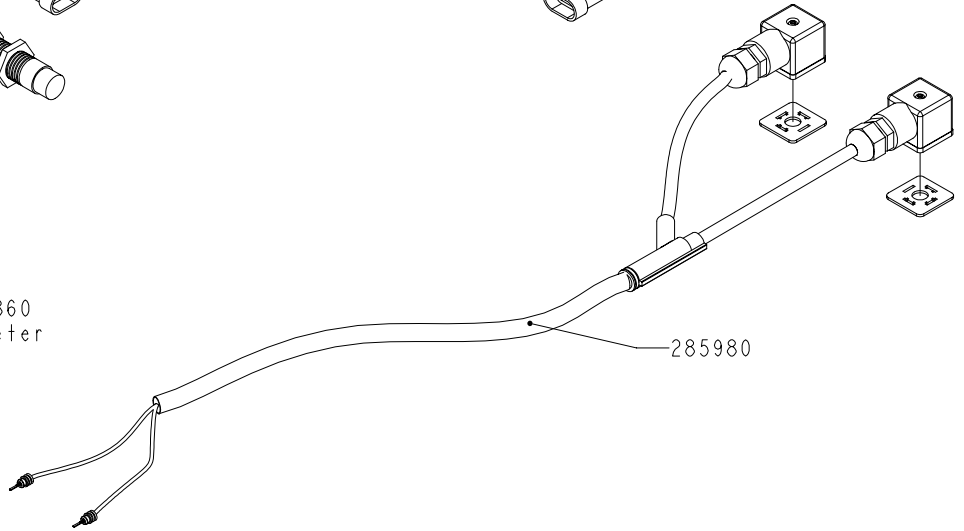
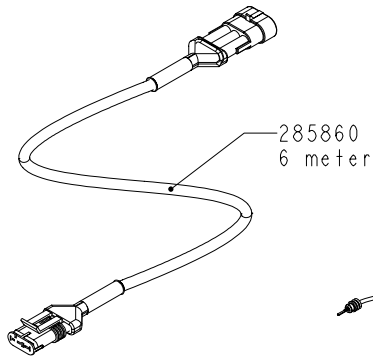
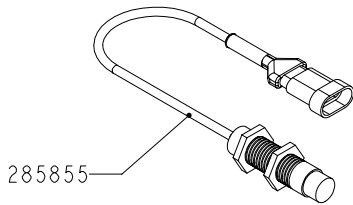
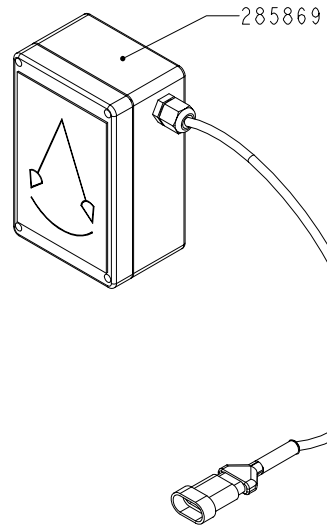
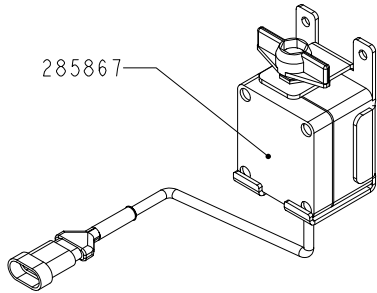

HARDI NOVA Harness

Trailer

Commander plus - HAZ					
Harness A	Harness B	Harness C-7.sek	Harness C-9.sek	Cable for armature 7,5 m	Armature connection box
285900	285934	285967	285969	285902	72115400

Commander plus - LPx/OLx/GVx					
Harness A	Harness B	Harness C-7.sek	Harness C-9.sek	Cable for armature 7,5 m	Armature connection box
285901	285936	285967	285969	285902	72115400

Lift

Mega - LPY/Z			
Harness A	Harness B	Harness C - 7.sek	Harness C - 9.sek
	285940	285968	

Marro - HAZ			
Harness A	Harness B	Harness C - 7.sek	Harness C - 9.sek
285902	285940		285970

Self-propelled

Alpha 4100 - HAZ		
Harness A	Harness B	Harness C - 7.sek
285903	285941	285971

Alpha 4100 - GVx		
Harness A	Harness B	Harness C - 7.sek
	285942	285972

