

HARDI CONTROLLER 5500

HARDI
CONTROLLER 5500
version 2.0
Instruction book
679027-GB-2003/08

HARDI INTERNATIONAL A/S is without any obligation in relation to implements purchased before or after such changes.

HARDI INTERNATIONAL A/S cannot undertake any responsibility for possible omissions or inaccuracies in this publication, although everything possible has been done to make it complete and correct.

Published and printed by HARDI INTERNATIONAL A/S.

HARDI CONTROLLER 5500

Table of Contents

Glossary and pictorials symbols	3
Operator safety	4
Description	4
System description	6
Power supply	6
Tractor installation	7
Speed transducer for tractor	9
Foot pedal remote ON/OFF (optional)	9
Start-up	10
Menu 2.4 Set clock	10
Navigation keys	11
General keystrokes and menu system	11
Menu 1 Daily settings	13
Menu 1.1 Volume rate	13
Menu 1.2 Tank contents	14
Menu 1.3.1 Register readout and selection	15
Keystroke menu tree chart (ver. 2.0)	16
Menu 2 Setup	13
Menu 2.1 Display readout	17
Menu 2.2 Auto	18
Menu 2.3 Variable Rate Application (VRA) / Remote	18
Menu 2.4 Set clock	19
Menu 2.5 Alarms	19
Menu 2.6 Register names	20
Menu 3 Calibration	22
Menu 3.1 Speed calibration	22
Menu 3.2 Flow calibration	24
Menu 3.3 Boom	28
Menu 3.4 Regulation constant	29
Menu 3.5 Tank gauge	29
Menu 4 Toolbox	32
Menu 4.1 Measure	32
Menu 4.2 Service intervals	32
Service interval reset	32
Menu 4.3 Stop watch	33
Menu 4.4 Alarm clock	33
Menu 4.5 Test	33
Menu 4.6 Speed simulation	33
Menu 5 Logbook	34
Menu 5.1 Print	34
Menu 5.2 Data dump	34
Mistblowers and Controller 5500	35
Storage	38
Emergency operation	38
Fault finding	39
Testing and fine tuning	40
Technical specifications	42
Chart for recording values	43
Extended menu chart (ver. 2.0)	44
EC Declaration of Conformity	46
Quick guide	47
2 Spare parts	49

HARDI CONTROLLER 5500

We congratulate you for choosing a HARDI plant protection product. The reliability and efficiency of this product depend on your care. Read and pay attention to this instruction book. It contains information for the efficient use and long life of this quality product.

Glossary and pictorials symbols

Controller	HARDI Controller 5500 with display.
Spray Box	HARDI Control Box with all basic control functions.
Junction box	Box on the sprayer for Controller and Control Box.
Transducer	Device that transforms variations to a signal. Also called a sensor.
[abc]	Text shown on the Controller display.
[X] or [Y]	Variable figures.
PPU	Pulses per unit. For speed and flow calibration, the unit measure is metre and litre respectively.
EVCD	Electric valve control unit with pressure dump.
VRA	Variable Rate Application (often referred to "GPS").
UCR	Unit Canopy Row, an application unit used on mistblowers.

Text shown in the shaded rectangular window will be seen on the Controller display.

NOTE: Only the three lowest lines of the display are shown, except where first line is relevant.

E.g.

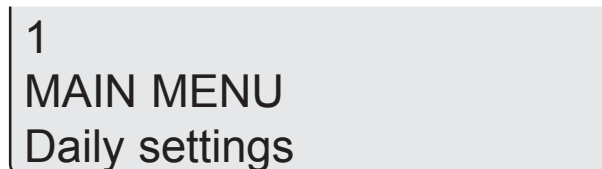









HARDI CONTROLLER 5500

Operator safety

Watch for the WARNING symbol . Your safety is involved so be alert!

Note the following recommended precautions and safe operating practices.

-  Read and understand this instruction book before using the equipment. It is equally important that other operators of this equipment read and understand this book.
-  Turn electrical power off before connecting and disconnecting the display and transducers, servicing or using a battery charger.
-  If an arc welder is used on the equipment or anything connected to the equipment, disconnect power leads before welding.
-  Test with clean water prior to filling with chemicals.
-  Keep children away from the equipment.
-  Do not use a high pressure cleaner to clean the electronic components.
-  Press the keys with the underside of your finger. Avoid using your fingernail.
-  If any portion of this instruction book remains unclear after reading it, contact your HARDI dealer or HARDI service personnel for further explanation before using the equipment.

Description

The HARDI Controller 5500 is for use in agricultural and horticultural production. The Controller permits automatic control of application rate.

Main components are:

- Controller
- Spray Box
- Junction box (on sprayer)
- Flow transducer (on sprayer)
- Speed transducer (on sprayer or tractor)

The Controller has a four line display permitting much information to be shown at the same time. Display readout includes volume rate, speed, liquid rate per minute, total covered area, total volume sprayed and 99 trip registers. It includes a total register that summarizes data from the 98 trip registers. It is illuminated internally so readout is possible even for night-time work.

HARDI CONTROLLER 5500

If used on a mistblower, volume applied can also be set up as “Unit Canopy Row”. Tree width and height can be changed on the go.

Functions include correct area with closure of up to 7 spray boom sections, alarm functions for volume rate, minimum tank contents, speed min./max. and possibility for audio/visual alarm.

The Spray Box has intergrated controls for the spray functions, foam marker, end nozzles and two electric valves.

The transducers utilised are chosen for long service life and good signal quality. The speed and flow transducer has a diode built into the housing to aid servicing. As the wheel or rotor turns, the diode will flash thereby indicating it functions.

The Controller is also compatible for Variable Rate Application and is prepared for communication with Precision Farming tools.

Data dump of registers and configuration to a personal computer is possible.

The system has a non-volatile memory with no battery which simplifies storage. All parameters in the menus are saved in the Controllers memory and are not lost when the power is disconnected.

The components are rain and dust proof and have been developed to last many years under agricultural conditions.

Optional transducers include pressure, revolutions and area meter. Other options include a 12 Volt printer and a foot operated remote ON/OFF for the Main ON/OFF.

HARDI CONTROLLER 5500

System description

1. Controller
2. Spray Box
3. To 12 Volt power supply
4. Multi wire plug and cable
5. Junction box (on sprayer)
6. Flow transducer
7. Speed transducer
8. Tank contents transducer (optional)
9. Printer (optional)
10. Harness for tractor speed/area switch/foot remote ON/OFF

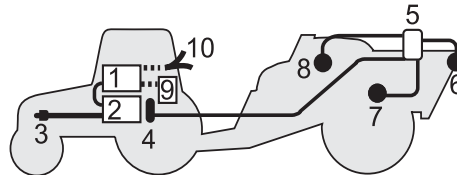

Power supply

The power supply is 12 Volt DC **12V**

Brown wire is positive “+”. 

Blue wire is negative “-”.

Power supply must come **directly from the battery**. The wires must have a cross-sectional area of at least 1.0 mm² to ensure sufficient power supply.

NOTE: Do not connect to the starter motor or generator/alternator.
Warranty is void if this is done.

Use the HARDI Electric distribution box (Ref. no. 817925) if the tractor has a doubtful wiring.

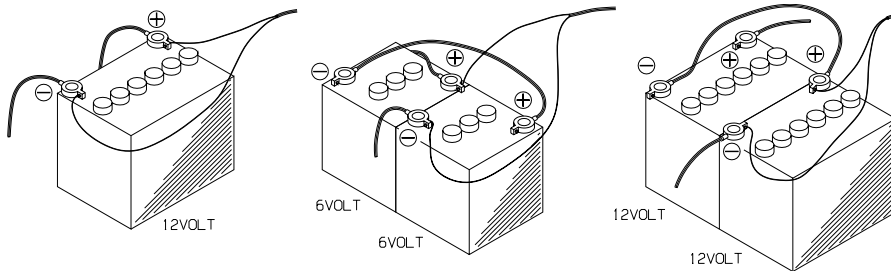

T165-0002

HARDI CONTROLLER 5500

Tractor installation

Brackets

The supplied tractor pillar bracket (A) has a hole spacing of 100 and 120 mm. Check tractor instructions manual for information regarding attachment points.

Three tubes (B) are supplied. One, two or all 3 may be used.

They can be bent and shortened.

A spacer (C) is also supplied to allow further attachment possibilities.

Find the best solution for your tractor or vehicle.

See the different suggestions on the next page.

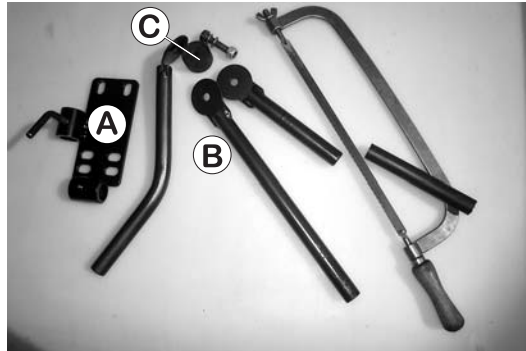

Spray Box

Best placement is to the right of the driver seat and in combination with the Controller. It should be secured from movement.



Controller

Mount it in the tractor cabin at a convenient place.

NOTE: An extension cable is available as an option if the Controller is to be placed further away from the Spray Box. (Ref. no. 261933)



HARDI CONTROLLER 5500



Printer

If the 12 Volt printer is fitted, the supplied tube can be utilised to fit the printer on the Controller/Spray Box brackets.

NOTE: The Controller and Spray Box should be protected from moisture and should be removed if the tractor does not have a cabin.

HARDI CONTROLLER 5500

Speed transducer for tractor

Note the following if the speed transducer is fitted to the tractor or vehicle.

The speed transducer is an inductive type. It requires a metallic protrusion (e.g. bolt head) to pass by it to trigger a signal. Recommended distance between protrusion and transducer is 3 to 5 mm.

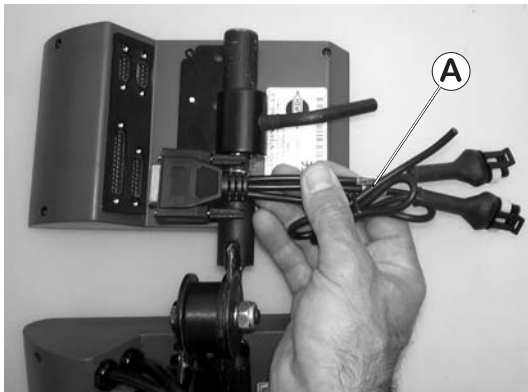

A speed/switch harness (A) and extension cable are needed to connect the speed transducer to the Controller.

Foot pedal remote ON/OFF (optional)

Note the following if the Foot pedal remote is to be fitted.

Remote ON/OFF switch has to be activated from the extended menu at installation. The HARDI Service centre does this.

NOTE: The main ON/OFF valve switch at Spray Box overrides all remote switches. It must be set to ON for the optional Remote ON/OFF switch to function.

The speed/switch harness (A) is connected to the Controller. Connect the plug from the Foot pedal ON/OFF to the correct connector on harness (A).



HARDI CONTROLLER 5500

Start-up

When connecting the 39 pin plug from the sprayer, note the lock pal (A) clicks in place to secure the plug in the socket.

When disconnecting the plug, the metallic pal must be pushed back before the plug is pulled out.



After connecting the plugs, the power is turned on at the Spray Box. Model, software version number, number of sections and size are displayed briefly. At initial start up, Controller also prompts for input of time and date. [Set clock to enable register].

Press  to continue.

Menu 2.4 Set clock

If the Controller prompts for date and time, [Set clock to enable register]: This must be done before the Controller is put into operation for the first time, otherwise no start and stop time will be recorded in the registers.

NOTE: If no prompt, the dealer may already have done this.

Press .

Press  to menu [2 Setup].

Press .

Press  to menu [2.4 Set clock].

Press  to enter menu [2.4.1 SET CLOCK].

Now you can choose between 24 hour or 12 hour clock with .

Press .

Set minutes, hours, year, month, day with  and .

Press  to confirm.

Press  and hold to exit menu system.

HARDI CONTROLLER 5500

Navigation keys

The navigation keys are initially used for set up in the menu system.

Press  to start this process.

NOTE: Some keys have other functions that can be used whilst spraying.

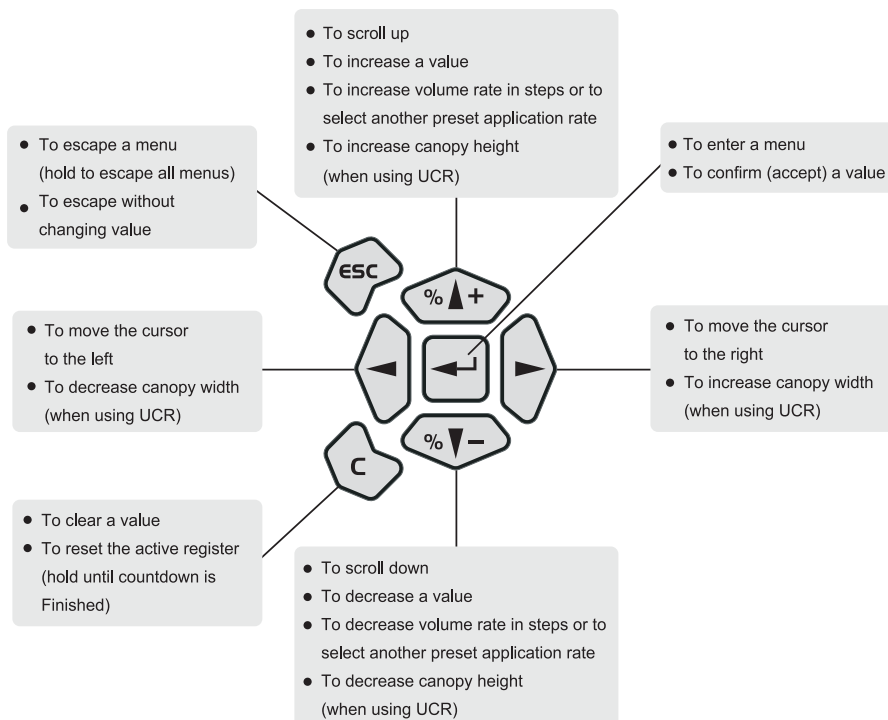

General keystrokes and menu system

The following is a general description in keystrokes and display readout. The following example, of changing the Tank contents value, is used to illustrate this. Try it! The same method is used in all the menus.

NOTE: When a menu is open, the blinking number or value is the one that can be altered.

HARDI CONTROLLER 5500

Press  to enter the menu system [1 MAIN MENU].

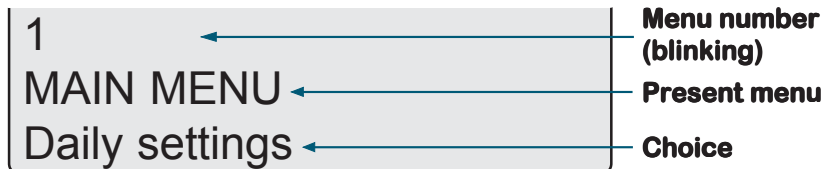



The 2nd line will show the menu number.

The 3rd line will read the present menu.

The 4th line will show a choice.

Note the menu number [1] is blinking.

Press  to enter menu [1.1 Daily settings].

Press  or  to scroll to [1.2 Tank contents].

Note the last digit of the menu number [1.2] is blinking.

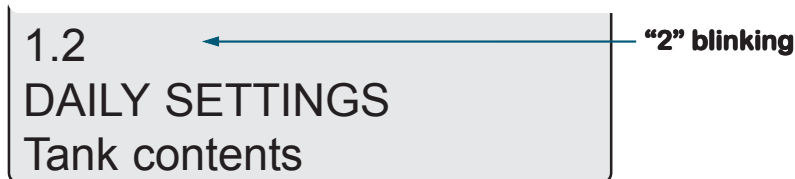

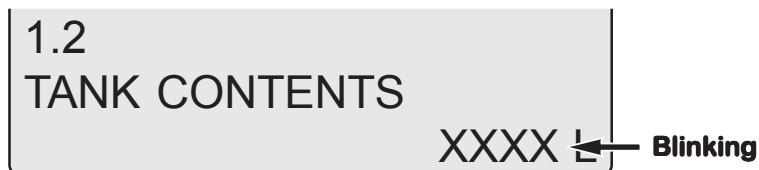

Press  to enter [1.2 TANK CONTENTS].



Note the value that can be changed is blinking.

Press  or  to move the cursor.

Press  or  to set the desired value.

Press  to confirm.

Press  and hold, to exit the menu system.

HARDI CONTROLLER 5500

Menu 1.1 Volume rate

The volume rate can be changed by:

1. Setting the desired rate in the Controller.
2. Manually raising or lowering the pressure via the Spray Box.
3. Pressing or to apply over or under in a preset percentage, e.g. 10% (the 3rd line indicates when this is active)
or
4. Pressing or to change to one of 3 preset volume rates.

Items 3 or 4 are only possible for broad-acre spraying.

To read the Volume rate:

Shortcut .

Press and hold until menu [1.1 VOLUME RATE] is shown.

1.1
VOLUME RATE
XXXX L/ha

To change volume rate:

Move cursor with or to the value to be changed.

Use or to change the value.

Press to confirm.

Press and hold to exit the menu system.

If the volume rate is set up with 3 programmable rates, there are three possibilities to enter volume rate.

[1.1.1 Rate 1] (Default)

[1.1.2 Rate 2]

[1.1.3 Rate 3]

NOTE: Normally, under 0.5 km/h, the Controller will not regulate automatically.

Manual dosage

To dose in manual mode, use the pressure switch on the Spray Box. The manual mode is indicated by the symbol at the top of the display.

To go from manual to preset volume rate, press .

HARDI CONTROLLER 5500

Menu 1.2 Tank contents

To change the displayed Tank contents:



Shortcut .

Press  and hold until menu [1.2 TANK CONTENTS] is shown.

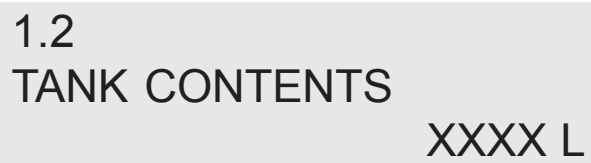
The maximum size of the tank is displayed



1.2
TANK CONTENTS
XXXX L

Press  or  to move the cursor to the value to be changed.

Press  or  to set the desired value.

Press  to confirm.

Press  and hold, to exit the menu system.

If the sprayer is fitted with one or more of the following, please see section “Tank contents options”.

- HARDI FILLMETER
- HARDI tank gauge
- Tank Control

Menu 1.3.1 Register readout and selection

Register 1 to 98 can be used for individual areas.

Register 99 is a tally of register trips 1 to 98. They are identified with a number and it is also possible to name them. The data is memorised when the system is switched off.

To read the data in the active register:

Shortcut .

Press  and hold until menu [1.3.1 Register XX] is shown.

Press  to enter register.

Press  to scroll through the data.

Press  and hold to exit the menu system.

To reset register:

Press  and hold until the countdown has ended.

Reset of a register can be stopped if the  key is released before countdown has ended.

To change the register:

Shortcut .

Press  and hold until menu [1.3.1 Register XX] is shown.

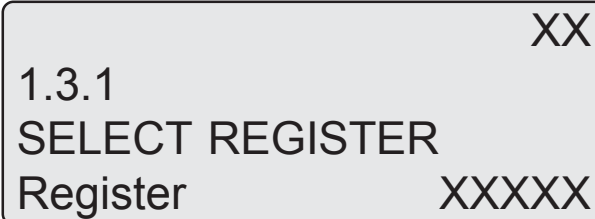



```

1.3.1
SELECT REGISTER
Register      XXXXX
XX
```

Press  or  to change the register.

The number is shown on the 1st line and if present, the name on the 4th line.

Press . If necessary, the register can be reset.

Press  until the countdown has ended.

Press  and hold to exit the menu system.

HARDI CONTROLLER 5500

Keystroke menu tree chart (ver. 2.0)

The first steps to choose a menu are shown below.

Press  to proceed into the menu. See the relevant section in the book.

Press  and hold to exit the menu system.

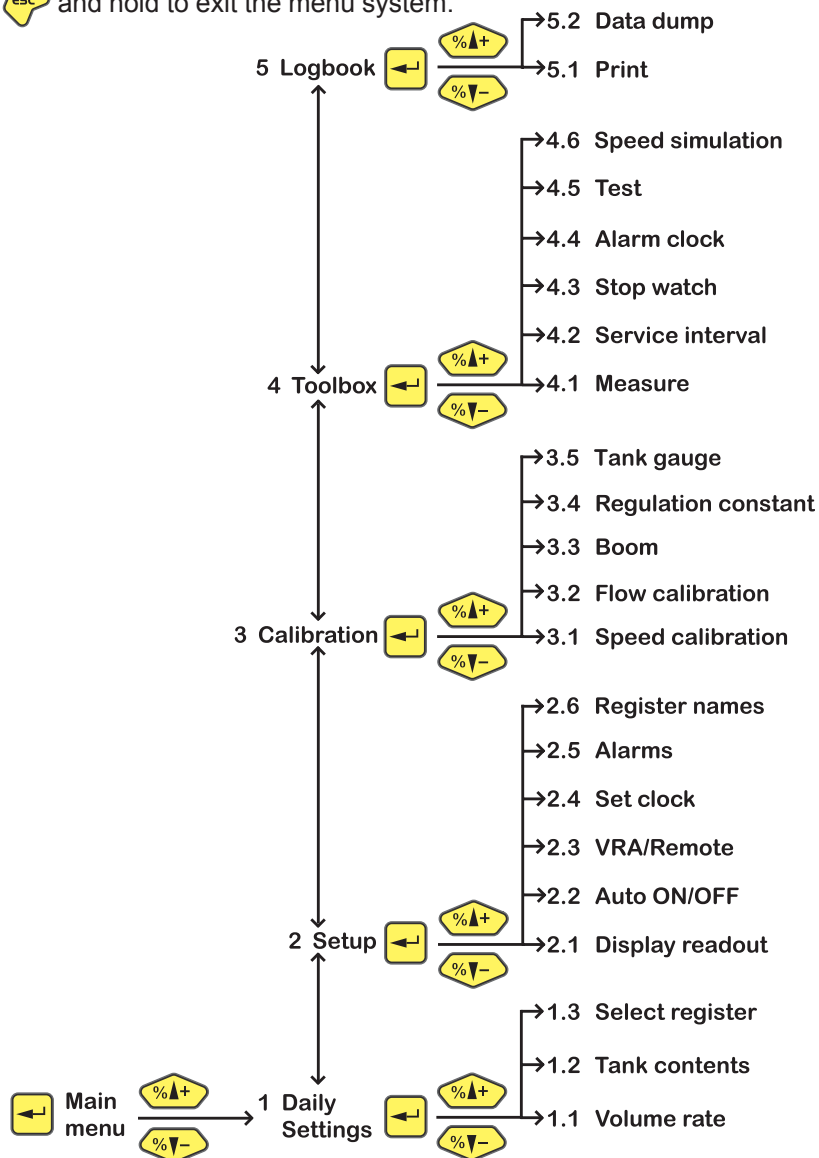

HARDI CONTROLLER 5500

The following menu explanations assume you have mastered the general keystrokes and you can “find your way” to the specific menu. If this is not so, please re-read “ Navigation keys” and “General keystrokes and menu system”.



Menu 2.1 Display readout

It is possible to freely choose which function is to be shown on the 3rd or 4th line of the display. Choose the submenus of menu [2.1 Display readout].

Menu [2.1 Display readout]

Choose a submenu e.g. menu [2.1.5 Work rate].

Press  to confirm.

Use  or  to choose which line is to show data.

Press  to confirm.

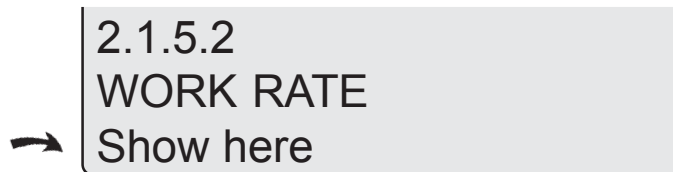

To show the work rate in 4th line.

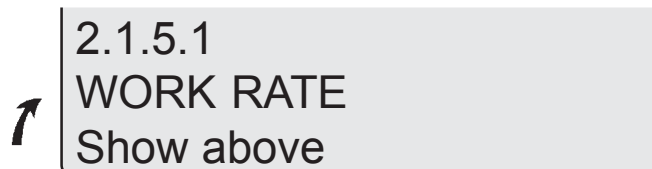

To show the work rate rate in the 3rd line of display.

Choices are listed as follows.

Display text	Description
[2.1.1 Program: Actual]	Programmed and actual application rate
[2.1.2 Flow rate]	Flow rate out to the boom
[2.1.3 Optional sensor]	There are 8 sub-choices
[2.1.4 Time]	Actual time
[2.1.5 Work rate]	Rate shown in hectares per hour
[2.1.6 Volume rate]	Actual rate in Litres per hectare
[2.1.7 Tank contents]	Main tank contents
[2.1.8 Speed]	Driving speed
[2.1.9 Volume: Area]	2 readouts on the same line
[2.1.10 Active boom size]	Active boom size including end nozzle.

HARDI CONTROLLER 5500

NOTE: If using UCR for mistblowers:

- Readout is only possible on the 4th line.
- Readout changes as listed below.

[2.1.1 Program: Actual]	Programmed and corrected rate
[2.1.5 Work rate]	Rate shown in metres per hour
[2.1.6 Volume rate]	Actual rate in Litres per UCR
[2.1.9 Volume: Area]	2 readouts on the same line

Menu 2.2 Auto functions

Menu [2.2.1 ON/OFF]

The Controller can be set to open the main ON/OFF function above a certain speed and close it below the same speed. This allows the user to concentrate on driving. If the speed is set at zero the function is deactivated. Suggested speed setting is spraying speed less 20%.

When the Auto ON/OFF is active and the main switch and boom section switches are on, the boom status symbol on the 1st line will blink when speed is under the trigger value.

WARNING: Remember to set the main ON/OFF switch to OFF before leaving the field, otherwise the main ON/OFF will open under transport.

Menu [2.2.2 Foam marker]

The Controller can be set to operate the HARDI Foam marker automatically through the main ON/OFF valve. When the main ON/OFF is ON, it will automatically start the Foam marker.

Furthermore, the Foam marker can be set for up and back spraying or race-track (round and round) spraying.

Setting	Activity
[Disable]	The marker will only follow the setting of the switch on the Spray Box.
[Same side]	The Controller will automatically activate the same side for race-track spraying.
[Change side]	The Controller will automatically change side for up and back spraying.

Foam marker status is shown on the line 4 of the screen every 5 seconds.

Menu 2.3 Variable Rate Application (VRA) / Remote

If the volume rate is to come from an external source (e.g. a site specific application map or a remote sensor), this menu has to be enabled.

HARDI CONTROLLER 5500

The  symbol on the 1st line is now visible. Manual pressure regulation and stepped over/under application is still possible.

The external source is connected to the COM 1 or COM 2 via a 9 pin sub D connector.

Menu 2.4 Set clock

See page 10.

Menu 2.5 Alarms

Six different alarms can be set up. Choices are listed as follows.

Display text	Notes
[2.5.1 Volume rate]	Suggested setting is 10%
[2.5.2 Tank contents]	Measured in Litres
[2.5.3 Optional sensor X]	High/low pressure
[2.5.4 Optional sensor Y]	High/low rpm
[2.5.5 Speed]	Speed max./min.
[2.5.6 Audio level]	0 = no sound, 5 is max. volume
[2.5.7 Sections off]	Sections switched to OFF

When outside the alarm parameters, the relevant warning will flash. The alarm beep can also be adjusted in audio level in menu [2.5.6 Audio level].

2.5.1
ALARMS
Volume rate

Volume rate alarm for over or under application
for more than 20 seconds.

Activated at XX %

Suggested setting is 10%. For no alarm, set at 0.

2.5.6
AUDIO LEVEL
Sound step X

HARDI CONTROLLER 5500

Menu 2.6 Register names

If desired, the registers can be given names. Once set up, a name can be copied and edited.

Press or to toggle between [Yes] or [No].

Press if the name can not be copied or edited.

A “?” will blink on the 3rd line.

Menu [2.6.XX Copy name]

2.6.XX	XX	Register number
?		Menu number
ABCDEFGHIJKLMN		3 rd line blinking
OP		Character set



Moves “?” one step to right.



Moves “?” one step to left.



or Changes character set.



Activates cursor in 4th line exchanging with “?” in 3rd line.



Leaves the menu.





No effect.

2.6.XX
A
ABCDEFGHIJKLMN
OP

HARDI CONTROLLER 5500

Assuming  is pressed, "A" will blink in both 3rd and 4th line.

 "B" will blink in both 3rd and 4th line.

 "P" will blink in both 3rd and 4th line.

 or  Changes character set.



 Selects character and returns to 3rd line.

The second letter can now be selected.

Menu [2.6.XX Copy name]

	XX
2.6.XX	
COPY NAME ?	
	Yes

Press  to select [Yes].

Press  or  to scroll through the defined names. The register number on the 1st line will change accordingly.

Press  to select.

The name can be copied and edited. The blinking cursor is for editing.

HARDI CONTROLLER 5500

Menu 3 Calibration

Menu 3.1 Speed calibration

The calibration process is the same for each sensor type. In the following example a “speed sensor on sprayer” is used.

Shortcut 

1. Press  until menu [3.1.1 Sprayer] is shown.

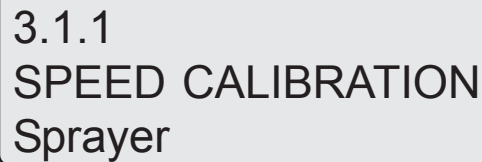



3.1.1
SPEED CALIBRATION
Sprayer

It is possible to connect the speed sensor at different locations. They are calibrated in the following menus:

[3.1.1 Sprayer]	Speed sensor on sprayer
[3.1.2 Tractor]	Speed sensor on tractor
[3.1.3 Radar]	Radar speed sensor

2. Choose with the navigation keys.
3. Press  to confirm. The last confirmed sensor is the active speed sensor.

Shortcut 

4. Press  until menu [3.1.X “Speed abc”] is shown.
5. Choose speed transducer. (Sprayer, Tractor or Radar) [3.1.1 Sprayer]
6. Press  to confirm.
7. Press  to read PPU value.



3.1.1.1
SPRAYER
Constant

The speed transducer can be calibrated theoretically or practically. The practical method is recommended.

Menu [3.1.1.1 Constant]

3.1.1.1
CONSTANT
XX.XXX PPU



The theoretical speed constant, pulses per unit (PPU), is the distance in metre on the circumference of the wheel between protrusion (or magnets).

E.g. If the wheel circumference is 2.00 m with 4 protrusions, PPU is 0.5000.

Menu [3.1.1.2 Practical]

3.1.1.2
SPRAYER
Practical

Practical calibration of speed is done by driving a measured distance and correcting the display so that the actual and the calculated distances are the same.

Calibration should take place in the field with a half full tank and normal working tyre pressure in order to obtain the wheel's real "working radius".

Method

1. Measure a distance not less than 75 metres.
2. Park the tractor at the start of the measured distance.
3. Press . When zero distance [0 m] shows, drive the distance.

3.1.1.2
PRACTICAL
Measured XXX m

4. Press .
5. Correct the distance shown on the display with the or to read the actual distance.
6. Press to confirm.

HARDI CONTROLLER 5500

Menu 3.2 Flow calibration

Menu [3.2 Flow calibration]

3.2 CALIBRATION Flow calibration

The flow transducer can be calibrated theoretically or with two practical methods. The practical methods are preferred. Calibration is done with clean water. The Flow Tank method is time consuming, but is more accurate than the Flow Nozzle method.

When changing to nozzles with more than a 100% increase or decrease in output, it is recommended to re-calibrate the flow transducer.

Calibration is recommended to be done at least once during the spraying season. Use the chart at the back of the book to record the values.

Menu [3.2.1 Flow constant]

3.2.1 FLOW CONSTANT XXX.XX PPU

Use the navigation keys to change the flow constant theoretically.

NOTE: PPU indicates the number of pulses which theoretically come from the flow transducer whilst 1 litre of liquid passes through. Approximate PPU values for different flow housings are as follows:

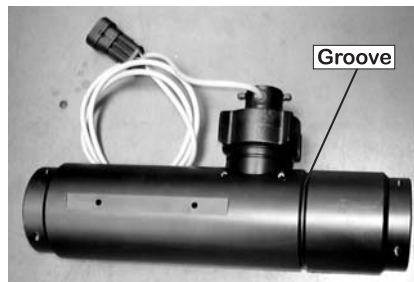

Housing	Housing identification	Flow range l/min	Orifice mm	PPU value
S/67	One outside groove	5 - 150	13.5	120.00
S/67	No groove	10 - 300	20.0	60.00
S/67	Two outside grooves	35 - 600	36.0	125.00

Menu [3.2.2 Nozzle method]

3.2.2
FLOW CALIBRATION
Nozzle method

During practical flow calibration the individual nozzle output on the display is compared to the actual individual nozzle output. The output displayed is corrected to read the actual output.

NOTE: See menu [3.3 Boom] if no boom data has yet been entered.

Method

1. Open all boom sections. Switch the main ON/OFF to ON. Close end nozzles (if fitted).
2. Go to menu [3.2.2 Nozzle method]. The display will then show the individual nozzle output per minute.



NOTE: If a section has not been opened or a end nozzle is not closed, the warnings below will show up in the lowest line on display. If the boom symbol on the 1st line blinks, set menu [2.2.1 ON/OFF] to [0.0 km/h].

Open all

Close end nozzle

3. Using a HARDI calibration jug, check the actual nozzle output per minute. It is recommended that an average of several nozzles be taken.

3.2.2
NOZZLE METHOD
XX.XX L/min

4. Press .
5. Correct the output shown on the display with the navigation keys to read the average output measured with the calibration jug.
6. Press  to confirm.

HARDI CONTROLLER 5500

Menu [3.2.3 Tank method]

3.2.3
FLOW CALIBRATION
Tank method

During practical flow calibration the tank is partly emptied through the nozzles. Whilst emptying, the display calculates the quantity emptied on the basis of the actual calibration value (PPU). The quantity displayed is compared with the quantity actually dosed.



This can be according to the tank contents level indicator or by weight difference before and after. The quantity displayed is corrected to read the quantity actually dosed.

Method

1. Place the tank on level ground and fill it up with water until the level reaches a unique mark on the tank contents level indicator, e.g. 1000 litres.
2. Open all boom sections.
3. Go to menu [3.2.3 Tank method] and switch the main ON/OFF to ON.
4. Engage the P.T.O.

3.2.3
TANK METHOD
Sprayed XXXX L

The display unit will then begin to count the volume being emptied through the nozzles.

5. When for example, 600 litres have been emptied out, as shown by the tank contents level indicator, disengage the P.T.O. and switch the main ON/OFF to OFF.
6. Press .
7. Correct the volume shown on the display with the navigation keys to read the volume shown on the tank contents level indicator.
8. Press  to confirm.

HARDI CONTROLLER 5500

Menu [3.2.4 Circulation]

The following is only relevant for sprayers equipped with circulation liquid system. The circulation type liquid system has to be set up from the Extended menu at installation. The HARDI Service centre does this.

See menu [3.2 Flow calibration] for calibration of "Flow 1". Flow constant from "Flow 1" is shown.

3.2.4.1
CIRCULATION
Flow constant

3.2.4.1
FLOW CONSTANT
XXX.XX PPU

3.2.4.2
CALIBRATION CIR.
XXX.XX l/min

"Flow 1" is used as a reference when calibrating circulation flow, "Flow 2".

Method

1. Ensure all boom sections and end nozzles are closed.
2. Go to menu [3.2.4.2 Calibrate circulation].
3. Press . The automatic calibration is initiated and line 4 will show:

Calculating PPU !

4. When finished the menu returns to [3.2.4.1 Flow constant] to show the new PPU.

HARDI CONTROLLER 5500

Menu 3.3 Boom

Menu [3.3.1 Width]

3.3.1 WIDTH XX.X m

Use the navigation keys to enter boom width.

Press  to confirm.

Menu [3.3.2 Number of sections]

3.3.2 NO. OF SECTIONS Sections XX
--

Use the navigation keys to set number of boom sections.

Press  to confirm.

For mistblowers, see section on mistblowers.

Menu [3.3.3 Nozzles / section]

3.3.3 NOZZLES / SECTION Section Y XX

Use navigation keys to set correct number of nozzles per section.

Press  to continue to next boom section.

Press  after the last section.

Menu [3.3.4 End nozzles] (Optional)

If end nozzles are fitted, set the value to the equivalent coverage by the boom nozzles.

E.g. End nozzle coverage is 2 metres. This is equal to [04 Boom nozzles].

3.3.4
END NOZZLES
= XX Boom nozzles

NOTE: It is important that the volume applied from the end nozzle matches the volume applied under the boom. This is a comparison of volume per minute per length. (Litre/min/metre).

When the end nozzle is active, the area covered and volume sprayed is calculated and registered. If “Active boom size” is displayed, it will show an increase when the end nozzle is activated.

Menu 3.4 Regulation constant

The sensitivity of pressure regulation valve can be adjusted. Increasing the regulation constant will give a faster response on the pressure regulation valve. If the constant is too high, the valve will become unstable. There will also be excessive wear on the valve. The range is in percent. The factory default is 50%.

Menu [3.5 Tank gauge]

This menu item is only present if the HARDI Tank Gauge is fitted. Flow calibration [3.2] must be done before proceeding.

Menu [3.5.1 Adjustment]

The correction factor for the specific gravity of the liquid sprayed can be set. Default value is 1.000.

For liquid fertilisers, the specific gravity may range up to 1.3 kg/L. The value in this case would be 1.300.

3.5.1
TANK GAUGE
Adjustment

HARDI CONTROLLER 5500

Press 

3.5.1.1
ADJUSTMENT
Spec. grav. X.XXX

Menu [3.5.2 Total]

This is for calibration of the HARDI Tank Gauge. The guide through the calibration step by step. A table with up to 100 data points corresponding to a correction value for each 25mm water level is created.

3.5.2
TOTAL STEP 1
Fill the tank

Method

1. Fill the tank to the maximum level (set in the Extended menu E8.4.1).

2. Press .

3.5.2
TOTAL STEP 2
Level sprayer

3. Press  after ensuring the sprayer is level.

3.5.2
TOTAL STEP 3
Open all

4. Open all boom sections and empty the tank. The pulses from the flow transducer are logged as data points in the Extended menu E8.4.4.

During this session the screen shows:



[xxxx] as the actual water level in millimetres and [yyyyyyy] is the number of pulses from the flow meter.

XXXX mm yyyyyyy

HARDI CONTROLLER 5500

5. Press  when the tank is empty.

3.5.2	
TOTAL STEP	4
Emptied	XXXX L

6. Correct the displayed volume with the  or  to the actual volume sprayed out.

7. Press . The new flow transducer PPU is calculated and the calibration of the HARDI Tank Gauge is finished.

HARDI CONTROLLER 5500

Menu 4 Toolbox

This menu contains a number of tools to help you if needed.

Menu [4.1 Measure]

This is a simple electronic “measuring tape”. You can measure distance. If the implement width is entered in menu [4.1.3 Working width], area can also be measured in menu [4.1.2 Area].

Use  to clear the value.

Menu [4.2 Service intervals]

Four service intervals and a nozzle check can be programmed into the Controller. This makes it easier for the operator to remember the service intervals.

From the factory, the Controller is set up with three service and a nozzle check reminder.

Menu & interval	Hours	Action
[4.2.1 Interval A]	10	See instruction book, Maintenance.
[4.2.2 Interval B]	50	See instruction book, Maintenance.
[4.2.3 Interval C]	250	See instruction book, Maintenance.
[4.2.4 Interval D]	-	Not defined from factory.
[4.2.5 Nozzle]	50	Check flow rate. Change nozzles if more than 10% of rated flow.

The importer or dealer may have added Interval D. If no interval is set, [D Not defined] is shown.

Press  to register the interval for service or control.

The warning  will remain present until the service interval is reset.

Service interval reset:

To reset service interval, go to relevant interval **[4.2.X* Interval X* or Nozzle]**.

Press  to reset hour metre.

Press  to confirm.

*X = Variable values

HARDI CONTROLLER 5500

Menu [4.3 Stop watch]

The clock can be used as a timer.

Press  to start and stop.

Use  to clear the value.

Menu [4.4 Alarm clock]

The clock can be set to give an alarm when the time is reached.

Press . Use navigation keys to set alarm.

Menu [4.5 Test]

All readouts for the transducers are in accumulated counts, i.e. one signal gives one count, except for the optional (analog) transducer that is read in milli-ampere.

Go to menu [4.5 Test]. Choose the item to be tested and open the menu.

Activate sensor and see if the signal is detected.

[4.5.1 Flow]. Enter this menu to test the flow sensor.

[4.5.2 Speed].

[4.5.3 Optional sensor].

[4.5.4 Active switches].

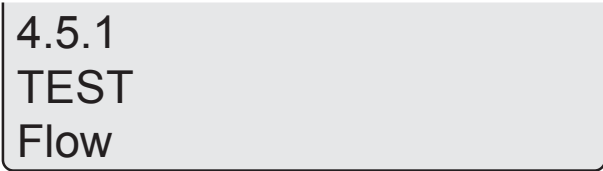

4.5.1
TEST
Flow

Menu [4.6 Speed simulation]

Speed may be simulated for certain purposes. A two figure value may be entered.

The state remains valid until the Controller is re-starting or the value is set to "0".

HARDI CONTROLLER 5500

Menu 5 Logbook

This menu has to do with dumping and printing of data.

Menu [5.1 Print]

The following can be printed via the 12 volt printer.

[5.1.1 Register number] A specific register

[5.1.2 All registers] Register 1 to 99. Only active ones will be printed.

[5.1.3 Configuration] This records all the parameters of the Controller.

Two examples of printouts is shown.

To the left is a printout of a specific register (menu 5.1.1).

To the right is a printout of the configuration (menu 5.1.3).

HARDI HC5500	HARDI HC5500 - configuration
Serial number 03011211	Serial number 03011211
Register 5 / MOUNT CLAY	SW version 1.52
Volume applied 1135 L	Register 0
Area 11.36 ha	Total volume applied 8768 L
Travelled spray distance 5.7 km	Total area 91.79 ha
Start date 31.07.03	Total travelled spray distance 37.4 km
Start time 12:19	Start date 01.07.03
Stop date 31.07.03	Start time 08:50
Stop time 13:27	Stop date 06.08.03
Time used (spraying time) 01:08	Stop time 06:22
Work rate 9.94 ha/h	Total time used (spraying time) 05:11
Average spray speed 4.9 km/h	Total work rate 17.70 ha/h
Max. spray speed 5.3 km/h	Total average spray speed 7.2 km/h
Average volume rate 100 L/ha	Total max. spray speed 14.0 km/h
Date printed 06.08.03	Total average volume rate 96 L/ha
Time printed 16:18	Programmed volume rate 0 L/ha
Notes:	Selected register number 5
	Auto ON/OFF, speed threshold Off
	VRA remote ON/OFF Off
	Clock set up 24
	Optional sensor 1 Pressure
	Optional sensor 2 Revolution
	Alarm volume rate +/- 0 %
	Alarm tank contents 0 L
	Alarm optional sensor 1 0/ 0
	Alarm optional sensor 2 0/ 0
	Alarm speed max. 0.0 km/h
	Alarm speed min. 0.0 km/h
	Alarm sections off Disable
	Audio level 0
	Sprayer speed PPU (active) 6.000 PPU
	Tractor speed PPU 1.000 PPU
	Radar speed PPU 1000.0 PPU
	Flow PPU (flow 1) 120.00 PPU
	Return flow PPU (flow 2) 0.00 PPU
	Boom width 24.0 m
	Number of sections 5
	Number of nozzle/section 12: 10; 4: 10; 12
	Opt. Sensor 1: 10.0 0.0 0.0 0
	Opt. Sensor 2: 0.000 0.00 0
	Opt. Sensor 3: 0.000 0.00 0
	Opt. Sensor 4: 0.000 0.00 0
	Opt. Sensor 5: 0.000 0.00 0
	Opt. Sensor 6: 0.000 0.00 0
	Opt. Sensor 7: 0.000 0.00 0
	Opt. Sensor 8: 0.00 0.0 0.0 3
	Specific gravity 1.000
	Foot switch type Disable
	Foam marker auto fct Disable
	Rate deviation resolution 10 %
	Fixed rate 2 150 L/ha
	Fixed rate 3 180 L/ha
	Max tank contents 4200 L
	Fill sensor type Not present
	Valve closing time 0.0 s
	Regulation constant 50 %
	Service interval A 10
	Service interval B 50
	Service interval C 250
	Service interval C Not present
	Service interval Nozzle 10
	Language GB
	Unit Metric
	Pressure system Equalization
	COM 1 set up Printer & dump
	COM 2 set up VRA/remote

Menu [5.2 Data dump]

The following can be printed to an office printer.

This could be done for example, using the Hyper Terminal function in Microsoft Windows.

Note the Hyper Terminal has to be activated and a cable connection and 12 volt power supply to the Controller and Spray Box is needed.

[5.2.1 Raw data]

[5.2.2 With header] Permits data to be set up with a column header.

Mistblowers and Controller 5500

Points to note if the system is used on a mistblower.

- For flow calibration, the Tank method is easiest.
- Fan revolutions can be read on the display if transducer is fitted.

UCR

Unit Canopy Row (UCR) is a calibration method based on the height and width of the canopy and the row length rather than area. UCR takes into account the three dimensions of a fruit tree or vine.

UCR is defined as a unit of canopy measuring 1 metre wide x 1 metre high x 100 metre long.

Future labelling of pesticides may include rate/UCR.

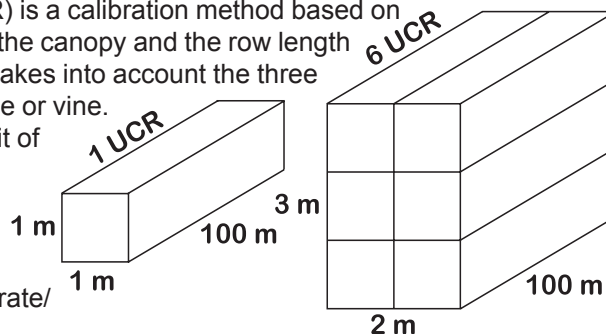

The Controller can be set up for mistblower to handle UCR. This is done from the extended menu. See “Extended menu” or contact your HARDI service centre if the Controller is not set up for UCR.

Once done, the 3rd line of the screen will show crop width and height and the application unit will be UCR.

The crop width and height can be changed during the season or on the go with the arrow keys to match the canopy size.

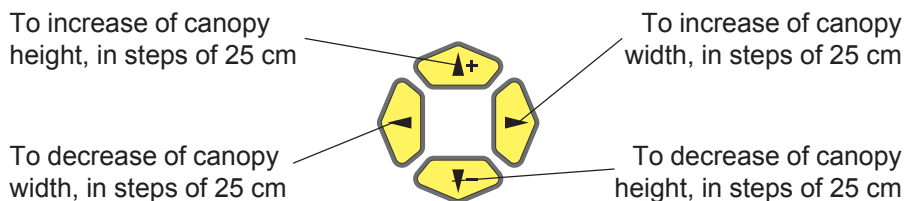

Fixed read out of canopy measures.

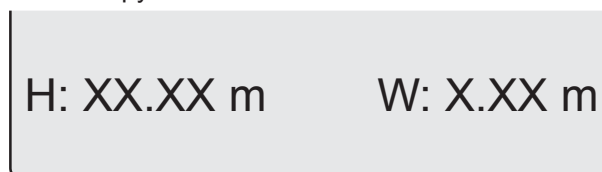

HARDI CONTROLLER 5500

Note the following changes when UCR is used.

Menu [3.3.1 Width]

The width is defined as the number of rows the sprayer can cover. This is readout only and can not be changed. It is a result of the data in menu 3.3.3. See below diagram on row coverage definition.

Menu [3.3.2 Number of sections]

This describes the controls of the orchard sprayer. Typically, they have 2, a left and a right.

Example:

Orchard sprayer with 2 section Spray box that is capable of spraying two complete rows.

Menu [3.3.2 Number of sections] = 2

Menu [3.3.3 Section size] = 100%

Menu [3.3.1 Width] is readout only and it will show "2 rows".

Menu [3.3.3 Section size]

Section width is entered in % row coverage. If a section covers half a row, the section coverage must be set to 50%. If a section covers 2 rows, the width must be set to 100% per section.

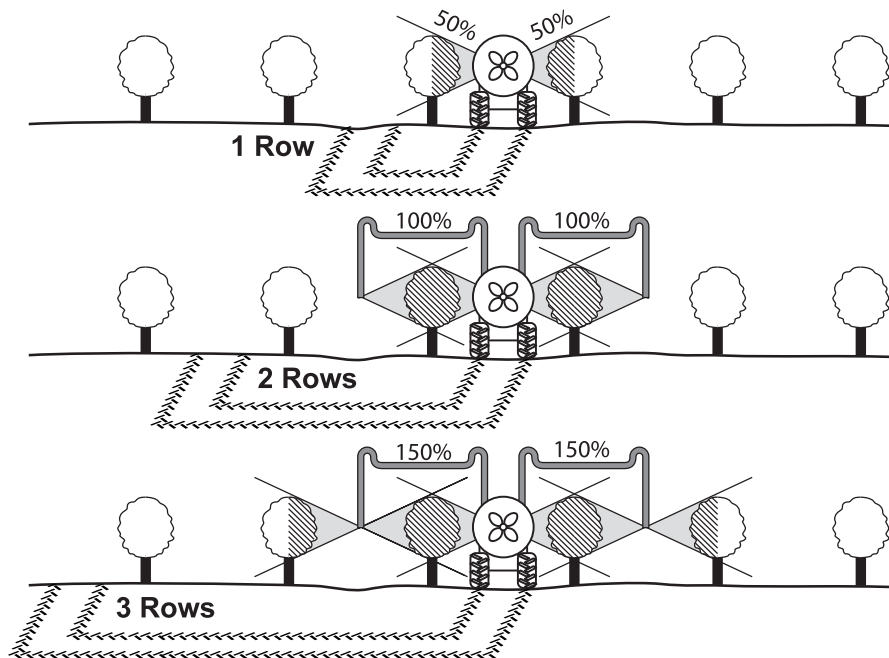

HARDI CONTROLLER 5500

Tank contents options

The sprayer may be fitted with a filling meter or tank contents transducer. This measures the volume passing to the tank. It sounds an alarm when the programmed volume is filled and the valve must be closed.

It may also be fitted with a shut-off on the filling line. This automatically closes when the programmed volume is filled.

The transducer and shut-off valve type fitted has to be activated from the Extended menu at installation. The HARDI Service centre does this.

Menu [1.2.1 Tank contents]

Shortcut

Press  and hold until menu [1.2.1 Tank contents] is shown.

Press  to set maximum tank contents.

Press  to confirm.

The filling volume can be changed in menu [1.2.2].

Menu [1.2.2 Fill meter] (optional)

```
1.2.2
FILL LEVEL:
Limit:                XXXX L
```

Press  for maximum tank contents.

Press  to clear or...

Press  or  for other value.

Press .

```
Contents:            XXXX L
Filled:              XXXX L
```

Actual contents and volume filled will be shown. The audio alarm will sound and the 3rd line will blink when the limit is reached.

HARDI CONTROLLER 5500

Fill limit Filled: XXXX L

Press  or  to stop the alarm.

Storage

When the tractor and sprayer is parked, disconnect the power supply to the Spray Box. This will stop the system from using power.

The Controller and Spray Box should be protected from moisture and should be removed if the tractor does not have a cabin.

Emergency operation

The Spray Box can operate the control unit without the Controller.

If you suspect the Controller is faulty, disconnect it from the Spray Box.

Spraying can now be continued. If the fault persists, it is not the Controller.

HARDI CONTROLLER 5500

Fault finding

<i>Failure</i>	<i>Reason</i>	<i>Repair</i>
Area is not being measured.	Boom width or speed constant have not been entered.	Enter the values in menu [3.3.1 Width] and [3.1 Speed calibration].
	No pulses are coming from the speed sensor.	Check the sensor, check the cable to the sensor for damage. If necessary, replace the sensor. Check sensor location [3.1 Speed calibration].
The volume rate L/ha is continuously displayed at "0".	Constant has not been entered.	Enter constant in menu [3.2.1 Flow calibration].
	Pulses of the flow meter are not reaching the sprayer control unit.	Check wiring. Check the impeller of the flow meter - it may be stuck.
The volume rate display is not correct.	The flow meter is not working properly.	Test the flow meter using menu [4.5.1 Flow].
	The area is not being registered exactly.	Check boom width and adjust if necessary. Re-calibrate speed [3.1 Speed].
The intended volume rate cannot be reached. The volume is below the pre-set rate.	The pressure motor has been wrongly poled. The rate is controlled downwards instead of upwards.	Check the control by using the +/- keys in manual mode. Change the control motor connections if necessary.
	The pump cannot deliver the required amount.	Increase PTO speed. Change to a lower gear.
	The filters are blocked.	Clean the filter.
The volume rate lies above the pre-set rate.	The pressure motor has been wrongly poled. The rate is controlled upwards instead of downwards.	Check the control by using the +/- keys in manual mode. Change the control motor connections if necessary.
	The return flow from the pressure motor to the tank cannot take superfluous quantity.	Check the tube system. Reduce the power of the pump (lower PTO speed, higher gear).
No speed readout.	Incorrect speed sensor location chosen.	Select the correct sensor on Sprayer, Tractor or Radar in menu [3.1.1 , 3.1.2 or 3.1.3].
Error message that fuse is active.	Short circuit in system. Fuse 1 = Section valves to left of centre and centre. Fuse 2 = Section valves to right of centre. Fuse 3 = Short circuit in all other switches.	Turn power OFF and locate problem.
Error message "Low voltage".	Low voltage.	Check battery and connections.

HARDI CONTROLLER 5500

Testing and fine tuning

Fine tuning the flow constant - PPU

Calibration of the flow transducer is carried out with clean water but small changes may occur when adding pesticides or fertiliser.

This will effect the final readings. This is typically noted when the volume displayed on the display does not equal the actual known volume that was sprayed out. The below formula can be used to "fine tune" the flow transducer PPU.

$$\text{New PPU} = \frac{\text{Original PPU} \times \text{Displayed Volume}}{\text{Sprayed Volume}}$$

For example, the spray tank is filled with 2400 litres of spray liquid. When sprayed out, the display showed a total of 2300 litres.
(Original PPU = 120.0)

$$\text{New PPU} = \frac{120.0 \text{ (Original PPU)} \times 2300 \text{ (Displayed Volume)}}{2400 \text{ (Sprayed Volume)}} = 115.0$$

Note the relation is inverse:

- To raise the displayed volume, the PPU is lowered.
- To lower the displayed volume, the PPU is raised.

Pin & Wire connection

AMP Super Seal	Box	GB	D	F	DK	E
2	+	Brown	Braun	Marron	Brun	Marrón
3	Sig	Blue	Blau	Bleu	Blå	Azul
1	-	Black	Schwarz	Noir	Sort	Negro

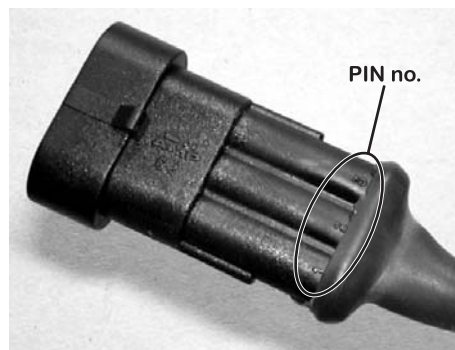

HARDI CONTROLLER 5500

Testing flow transducer

BROWN wire to positive of 12 volt battery.

BLACK wire to negative.

BLUE wire to multimeter positive.

1. Check the rotor turns freely.
2. Each vane in the rotor has a magnet in it with the pole facing out.
Check that the 4 magnets are present.
3. Check every second magnet has the same pole orientation so the rotor magnets are N - S - N - S.
4. Connect negative from multimeter to negative of battery.
5. Set multimeter to DC volt.
6. By turning the mill wheel slowly, this will register approx. 8.0 +/- 1 volt with the diode on and 0.3 +/- 0.1 volt with the diode off with every second magnet.

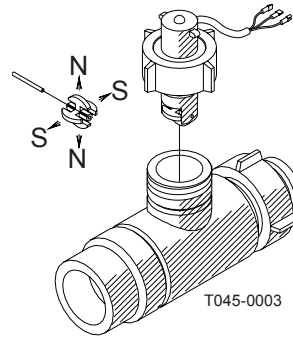

Testing speed transducer

BROWN wire to positive of 12 volt battery.

BLACK wire to negative.

BLUE wire to multimeter.

1. Connect negative from multimeter to negative of battery.
2. Set multimeter to DC volt.
3. Bring a metallic object (distance 3 to 5 mm) up to the transducer. This will register 1.4 +/- 0.2 volt and the diode will turn on.
4. By removing the object, this will register 12.0 +/- 1.0 volt. Diode is OFF.

HARDI CONTROLLER 5500

Technical specifications

Supply voltage	12 Volt DC
Controlled shutdown "low battery"	9 Volt DC
Maximum supply	16 Volt DC
Maximum peak	28 Volt DC
Ambient temperature	- 5°C to + 70°C
Memory	Flash PROM non-volatile
Digital transducers (option 2, 3 and 4)	Square signal
Frequency	0.5 Hz to 2 kHz
Trigger high	4.0 to 12.0 Volt DC
Trigger low	0.0 to 2.0 Volt DC
Analog transducers (option 1)	
Supply	12 V
Input	4 to 20 mA
Minimum speed for volume regulation	0.5 km/h

Flow ranges for the flow transducers

Identification code	Orifice	Flow
No outside groove	20.0 mm	10 to 300 l/min
One outside groove	13.5 mm	5 to 150 l/min
Two outside grooves	36.0 mm	35 to 600 l/min

Pressure drop over 13.5 mm orifice is 1 bar at 150 l/min.

Packaging information

Materials used for packaging are environmentally compatible.

They can be safely deposited or they can be burnt in an incinerator.

Recycling

Cardboard: Can recycle up to 99% and therefore should be put into the waste collection system.

Polyethylene: Can be recycled.

When the Controller and Spray Box has completed its working life, it must be thoroughly cleaned. The synthetic fittings can be incinerated.

The printed circuit boards and metallic parts can be scrapped.

HARDI CONTROLLER 5500

Chart for recording values

Menu	Function	1 - Values	2 - Values	3 - Values
Identification	Nozzle/Colour			
[3.2.1 Flow constant]	Flow PPU			
[3.1.X.1 Speed constant]	Speed PPU			
[3.4 Regulation constant]	%			
Fillmeter constant				

HARDI CONTROLLER 5500

Extended menu chart (ver. 2.0)

This menu has been set up by your HARDI Service centre.

It contains parameters that are typically set only once, normally before the Controller is used.

NOTE: Unless instructed, do not tamper with the settings and values in these menus. Failure to do so may void warranty.

This menu is accessed by pressing  before power on until the menu is entered.

See chart on next page.

HARDI CONTROLLER 5500

 EC Declaration of Conformity

Manufacturer,
HARDI INTERNATIONAL A/S
Helgeshøj Allé 38
DK 2630 Taastrup
DENMARK

Importer,

declare that the following product;

.....
.....

Adhere extra shipping package labels to inside cover.

.....

was manufactured in conformity with the provisions in the EMC directive 89/336/EEC, ISO 14982 Agricultural and forestry machinery - Electromagnetic compatibility - Test methods and acceptance criteria.

Taastrup, August 2002



Lars Bentsen
Product Development Manager
HARDI INTERNATIONAL A/S

HARDI CONTROLLER 5500

Quick Guide: Hardi Controller HC 5500



1st line symbols

- A Automatic or manual status
- B Variable rate application status
- C Service interval warning
- D Boom status without dual line:

	D 1	D 2	D 3	D 4
	—	▬	⚡ Flashing	☂ Spraying
Section:	off	on	on	on
Main:	off	off	on	on

- E Active register (area trip)

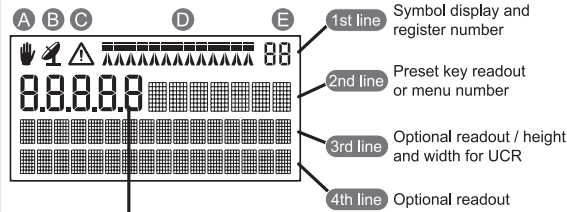

Connections

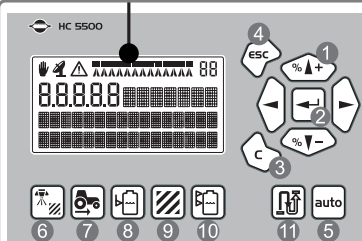
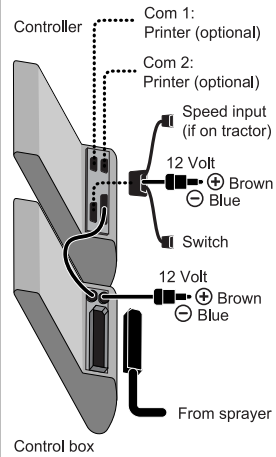

Spray box switch functions

- 1 Navigation keys (raise, lower, left, right)
- 2 Confirmation key (or Enter)
- 3 Clear key (zero's value)
- 4 Escape key (no value change)
- 5 Activates automatic control and clears % over/under rate

Preset (press)

- 6 Volume rate
- 7 Speed
- 8 Tank contents
- 9 Area
- 10 Sprayed amount
- 11 Remaining distance or area

Short cut (press & hold)

- Menu 1.1 Volume rate
- Menu 3.1.1 Speed calibration
- Menu 1.2 Entering tank contents
- Menu 1.3.1 Choosing register
- Menu 1.3.1 Choosing register
- Menu 4.1.1 Measuring distance or area

6-11

Press key shortly and it will show the preset readout.
Hold key down for a moment and it will work as a short cut, to a certain menu.

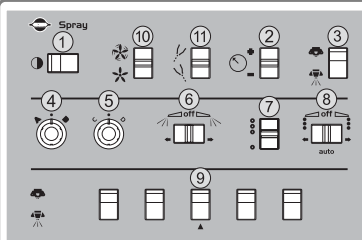

Spray box switch functions

- 1 Power switch
- 2 Manual pressure regulation
- 3 Main ON/OFF valve
- 4-5 Optional function, e.g. electric valve etc.
- 6 End nozzle ON/OFF
- 7 Foam marker regulation
- 8 Foam marker left, OFF, right
- 9 Section valves ON/OFF
- 10 Air slotangle (TWIN only)
- 11 Air volume (TWIN only)

679028 version 2 - GB - 06.08.2013

HARDI CONTROLLER 5500

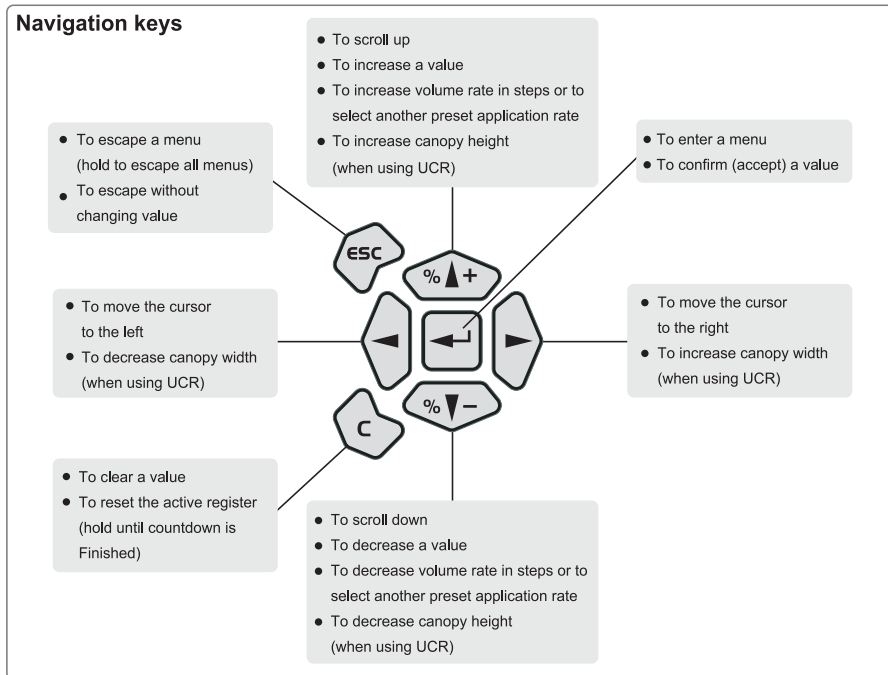

Basic to get going

Boom data, flow and speed calibration and volume rate must be entered.
Go to the menu on the Controller and find the relevant section in the instruction book

Boom data

- [3.3.1 Width]
- [3.3.2 Number of sections]
- [3.3.3 Nozzles per section]

Volume rate

Press  and hold until [1.1 VOLUME RATE] is shown.

Flow meter calibration

[3.2.1 FLOW CONSTANT

The below PPU value is approximate and a practical calibration is recommended.
The standard values for HARDI flow housing are

ID Code	Orifice mm	Flow range L/min	Approx. PPU
One outside groove	13.5	5 to 150	120.00
No outside groove	20.0	10 to 300	60.00

Speed calibration

Press  and hold until one of the following is shown.

- [3.1.1 Sprayer] Sensor on sprayer
- [3.1.2 Tractor] Speed sensor on tractor
- [3.1.3 Radar] Speed sensor is a radar

The practical calibration is recommended

HARDI CONTROLLER 5500

Spare parts

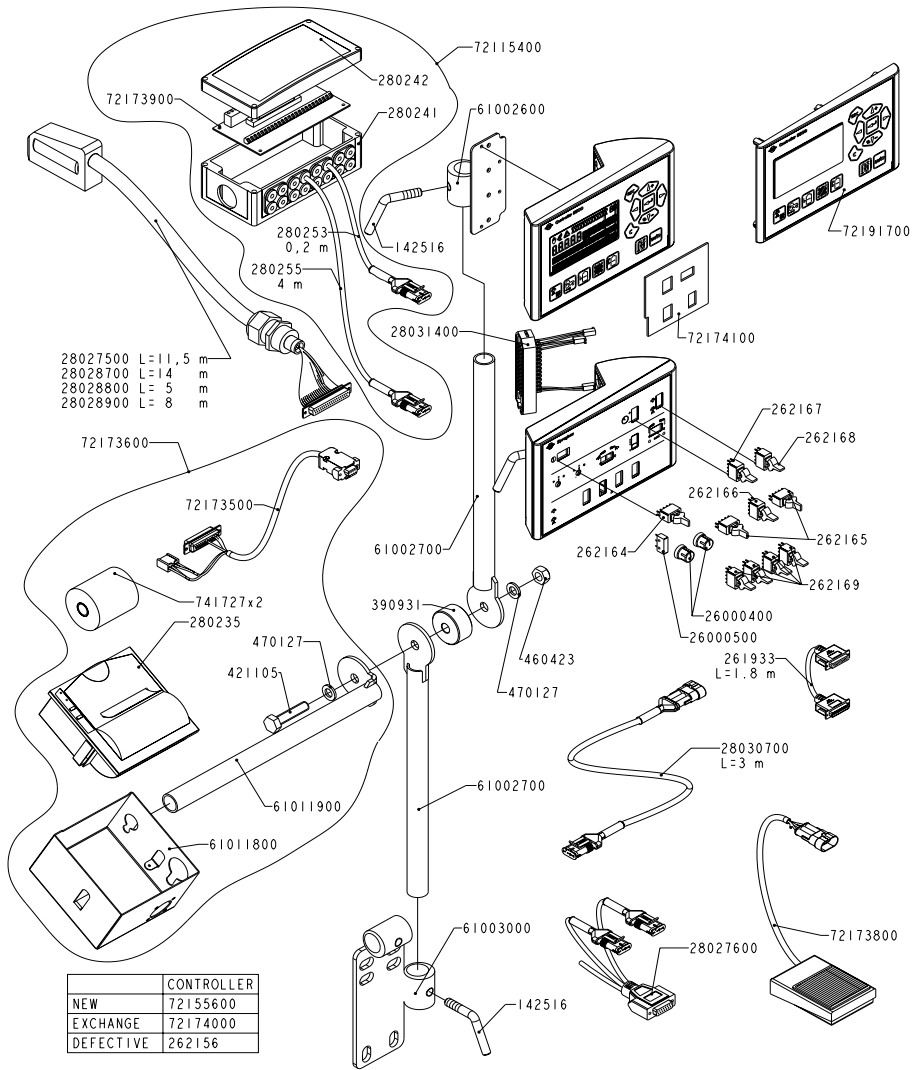

	CONTROLLER
NEW	72155600
EXCHANGE	72174000
DEFECTIVE	262156

CONTROL BOX	2 SEC.	3 SEC.	4 SEC.	5 SEC.	6 SEC.	7 SEC.	8 SEC.	9 SEC.
NEW	72168700	72168800	72168900	72169000				
EXCHANGE	72174300	72174400	72174500	72174600	72174700	72174800		
DEFECTIVE	262157	262157	262157	262157	262157	262157	262157	262157

K518

HARDI CONTROLLER 5500

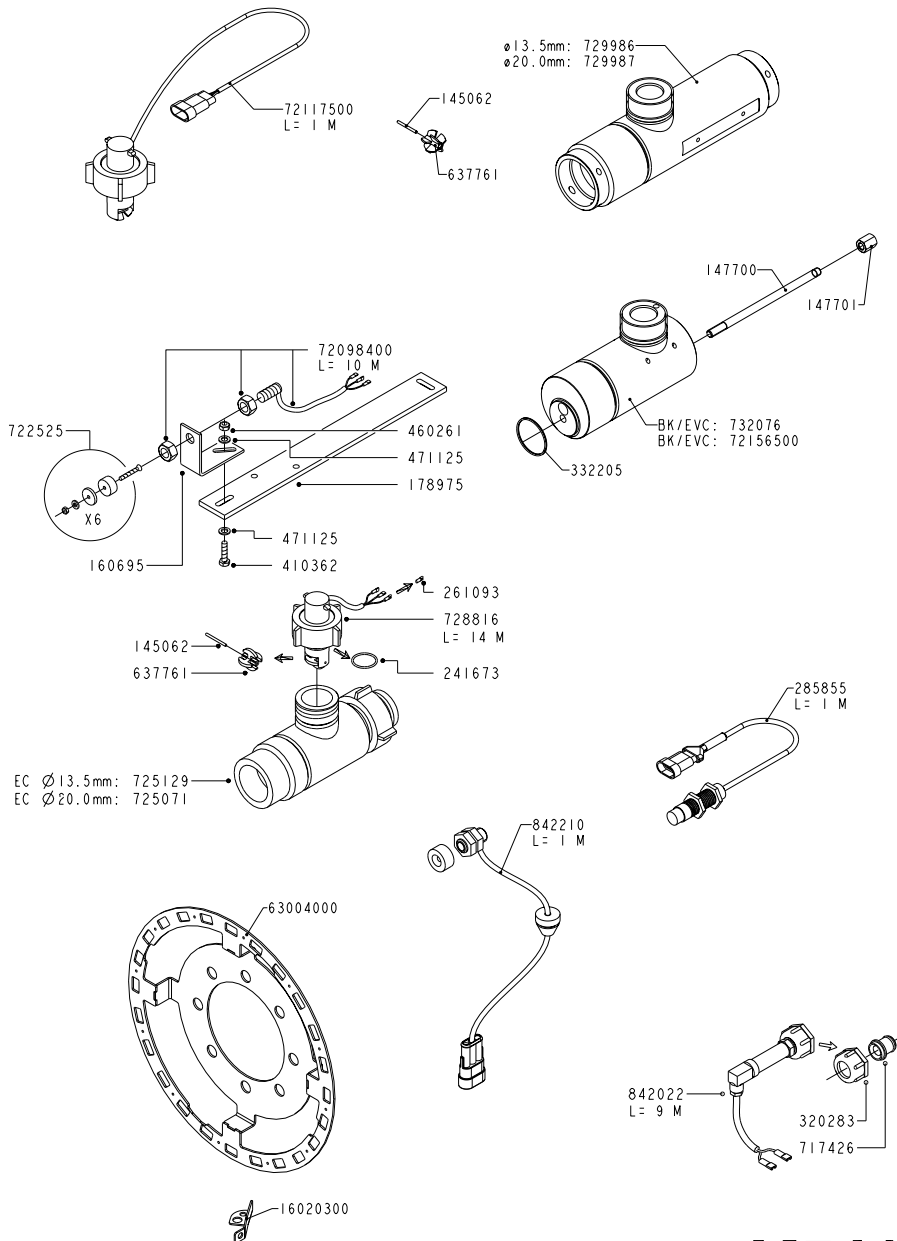

K519