

Notes:

Please note

HARDI TRONIC series No. _____

Table of Contents

Description	4
Operating Diagram	5
Before Use	7
Keyboard Explanation	9
Operation and Function	10
Calibration	15
Optional Extra	20
Maintenance and Winter Storage	22
Fault Finding	23
Spare Parts Drawings	25
Assembly	26

TRONIC 1800

Instruction book

674938-GB-87/10



Description

The HARDI TRONIC 1800 is an electronic spray monitoring system, which measures and displays the travel speed, measures, displays and controls the applied spray liquid. It informs on details of total spray liquid volume, total area treated, etc.

The electronic spray equipment consists of a processor control unit with keyboard and two LCD displays, where the actual values can be read during spraying.

In order that the HARDI TRONIC can give the correct information the processor control unit must be programmed with some known values before starting.

At the back of the display are found 5 plugs to connect to the sensors. See label and colour code.

Speed sensor, flowmeter, area switch and pressure transducer as well as connection to tractor battery for light in display. Model description and series number are stated on the label.

For measurement of the forward speed and area treated a speed sensor is placed on the tractor front wheel. The speed sensor is activated by a number of magnets sending impulses to the processor unit.

A flowmeter built into the operating unit is used to measure the amount of liquid applied. The flowmeter sends impulses to the processor unit which again calculates the liquid volume and flow per time unit.

Notes:

Notes:

Optional Extras

Pressure Transducer

A pressure transducer is used for measurement of the spray pressure. It gives signals which are converted in the processor unit to atmospheric pressure (bar/psi).



Area Switch

An area switch is used for measurement of the area to be treated. In principle this one is identical with the speed sensor. This sensor replaces the flowmeter, as the area switch is used with other implements such as fertilizer spreaders, seeding machines, harrows etc. This means that flowmeter plug is removed from the back of the TRONIC processor control unit and the area switch plug fitted.

Operating Diagram

- A. Electronic display and keyboard
- B. Power supply from tractor battery
- C. Flowmeter for applied liquid
- D. Speed sensor with magnets for speed measurement
- E. Area switch when using other types of implements
- F. Pressure transducer

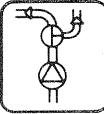

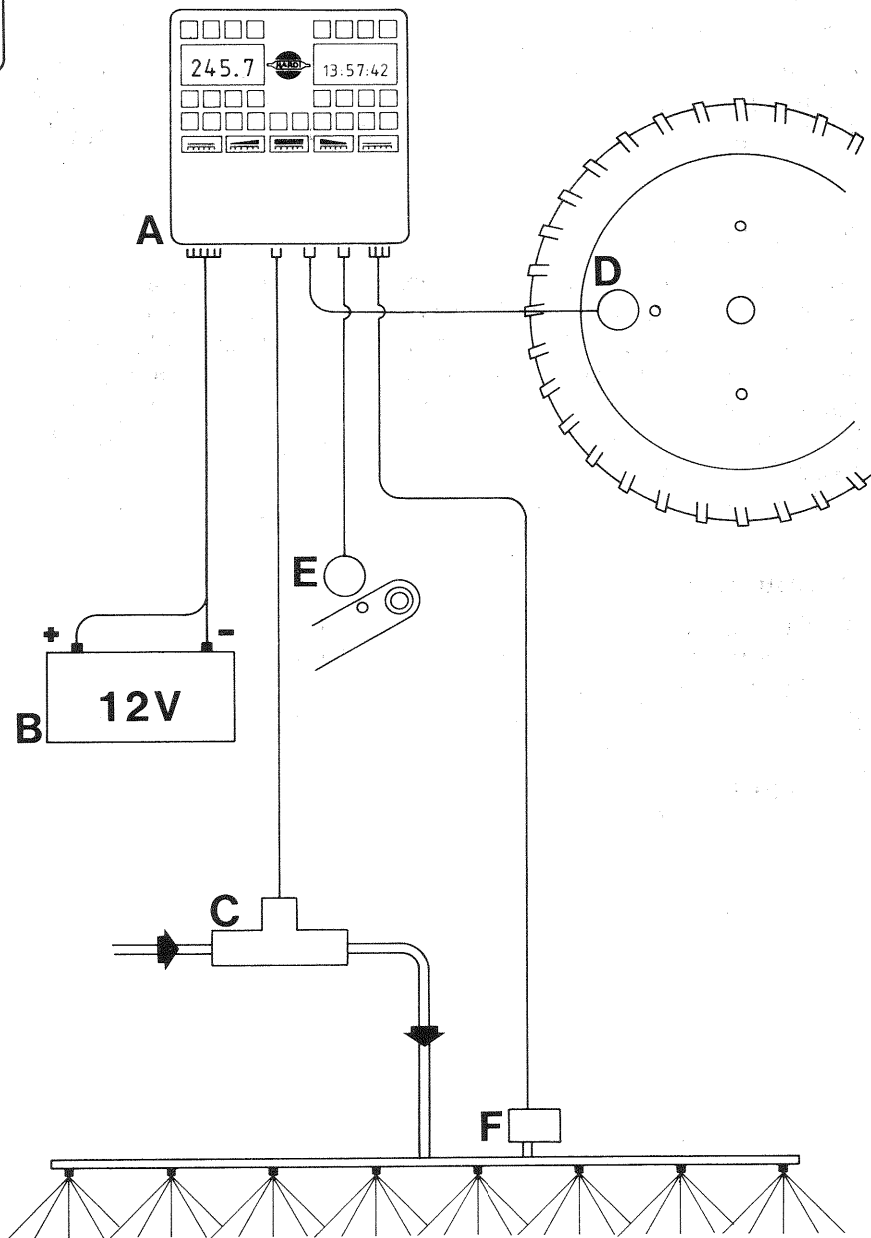
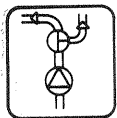

Installation of Area Switch (Optional Extras)

This switch is used in connection with other implements and can be installed at different locations depending on the type of implement.

The area switch can be fitted at

- the lift function of the tractor
- engaging lever for PTO shaft
- on/off function of the implement
- lift/lowering function of the semi-mounted implements

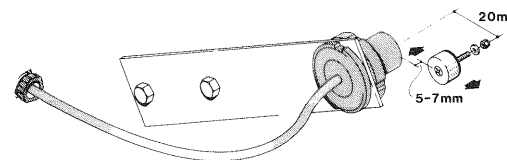

To stop the area signals, magnet and sensor must be precisely opposite each other. In this position the distance must be between 5 and 7 mm (distance between sensor and magnet). To start area signals the magnet must be moved at least 20 mm away from the centre of the sensor.



Fitting of Processor Control Unit

Fit the processor control unit in a suitable place in the tractor cab so reading of display and keying are easily done.

Fit the bracket so the plugs on the back of the HARDI TRONIC can easily be connected.

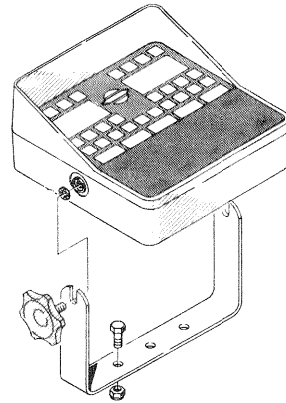

When using a pressure transducer and for lighting up the display, the HARDI TRONIC must be connected to the tractor electric system which must be 12 V. Connect the brown wire to the positive terminal (+) and the blue one to the negative terminal (-).

Installation of Pressure Transducer (Optional Extras)

Fit the pressure transducer at the end of a boom tube.

A. Choose one on the central section. Lubricate the O-ring before fitting the pressure transducer to the boom tube.

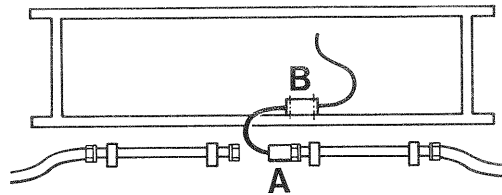

B. Fasten the junction box on to the central section. Drill two 3.5 mm holes. Dismantle the cover of the box and mark off the holes.

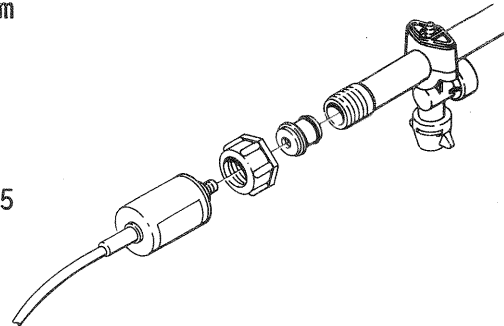

Before use

Power Supply

A battery cover on the back of the HARDI TRONIC is opened by loosening the screw. The HARDI TRONIC supplied with electricity from 4 1.5 V batteries, type LR 14. The light in the display comes from the tractor 12 V power supply.

The life of the batteries is 400 - 1200 working hours. In cold weather the TRONIC should be kept in a warm place, otherwise battery life will be reduced. The TRONIC should be turned off, when not in use.

NB: Change of batteries must be made in more than 15 min. Otherwise all the constants will delete and have to be coded again. The display must be turned off before changing batteries.

The display BAT shows - on the left display under |●| the on/off pad, when the batteries are losing their effect and must be replaced within 24 hours.

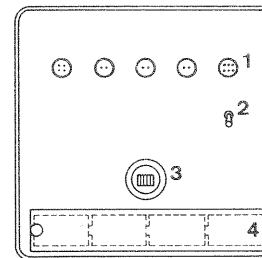

1. Connection of sensors.
2. Switch for light in display.
3. Switch
4. Fitting of batteries

Connection of Wires from Sensors

5 plugs from the various sensors fit sockets on the back of processor control unit. See label and colour coding.

HARDI-TRONIC	NR	HARTVIG JENSEN & CO. A/S 6 FARVERLAND - DK 2600 GLOSTRUP - DENMARK		
Pressure	Areameter switch	Speedometer	Flowmeter	12V/Driverbox





To Illuminate the Display

By activating the rocker switch on the back of the control box the display will light up.



Slide Switches

Behind the protection cover also at the back of the TRONIC are found 5 slide switches. Before coding the various values in the calculation unit, these switches must be correctly set.

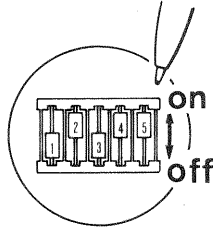

Switch No.

1. For reset of the processor control unit cancel all previous constants. The switch must always be at OFF position. Only if you want to cancel all previous constants, the switch must be set at ON and then back to OFF.
2. Pressure equalisation system. When the operating unit on the sprayer is equipped with pressure equalisation valves, the switch is set at OFF. In case of no pressure equalisation system the switch must be set at ON.
3. Choice of unit system.
Metric
Bar, hectare, litre, kilometre: Set switch at ON.
US/Imp.
Psi, acre, gallon, miles: Set switch at OFF.
4. Switch for locking of constants.
Before calibration the switch is set at OFF.
When the wanted constants are fed into the processor control unit and are to be retained the switch is set at ON.

Fitting of Magnets on Wheel Rim

With rim sizes up to a diameter of 20" 4 magnets are fitted. With rim sizes above 20" 6 magnets are fitted. It is important that the distance between all magnets is the same. The distance must not be smaller than 150 mm between two magnets. 4.5 mm holes are bored in the rim plate. Enclosed paper model can be used for marking-off the 4.5 mm holes.

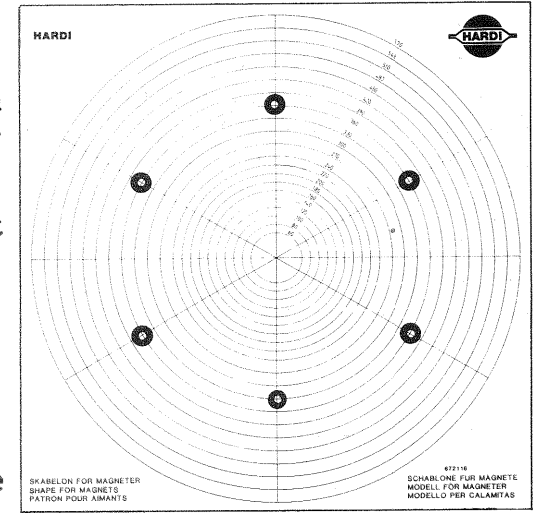

Installation of Speed Sensor

The speed sensor bracket is adapted and fitted to the machine so that the magnets will pass the speed sensor at a distance of 5 - 7 mm. If the speed sensor bracket is to be welded to the tractor, remember to disconnect the wires from the tractor battery.

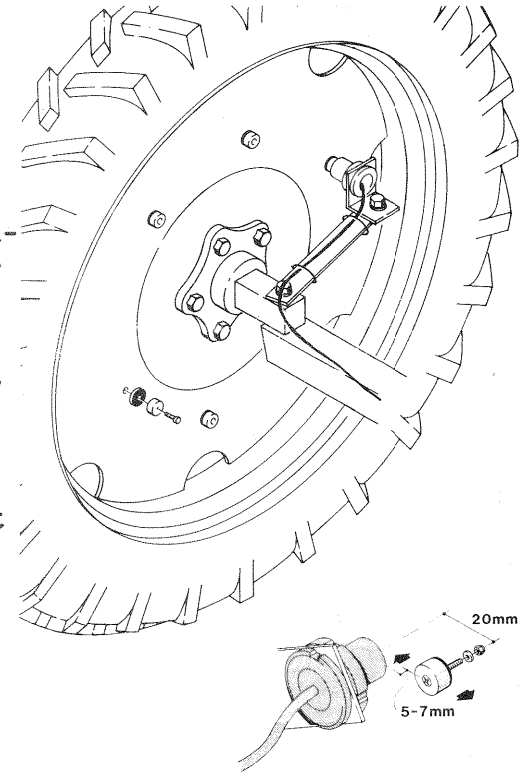



Fitting of Flowmeter on EC-Operating Unit

When fitting the flowmeter to the EC-operating unit dismantle the unit part, consisting of the pressure regulating valve and the on/off valve, from the sectional valves and the operating unit bracket.

The flowmeter is installed.

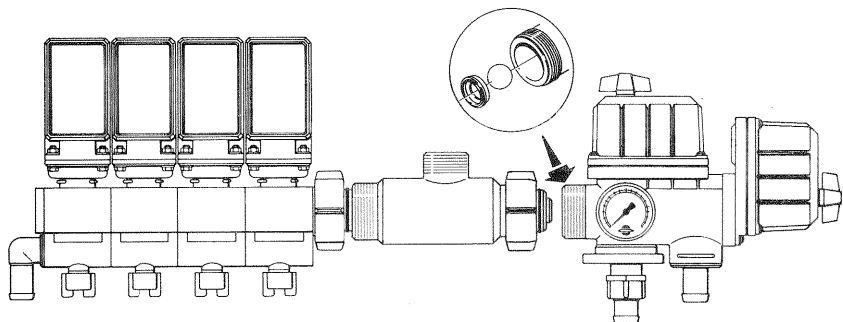

IMPORTANT: It is important that ball and ball seat are correctly fitted.

Lubricate O-rings before fitting flowmeter.

Fix operating unit to its bracket.

5. Built-in signal damping system. Switch must always be set OFF.









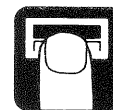



THE SWITCHES MUST ALWAYS BE OPERATED WITH CAUTION. FOR INSTANCE, USE A BALLPOINT PEN OR A SMALL SCREW DRIVER TO OPERATE THE SWITCHES. NEVER USE A PENCIL, THE GRAPHITE MAY CAUSE A SHORT IN THE SYSTEM.

NB: Do not forget to fit the protection cover after resetting of switches.

Keyboard Explanation



-  Main switch, ON/OFF for processor control unit.
-  Display of actual application rate. Preselected application rate.
-  Incorrect application. If the actual application is less than the one preset, a negative sign is shown on the display at the extreme left. If the actual application is higher than the one preset, there will be no corresponding positive sign.
-  On/off for application alarm (acoustic alarm).
-  Display of total liquid volume applied.
-  Display of total distance.
-  Display of total area treated.
-  Clock function (hours/min./sec.).
-  Display/calibration of liquid volume rate/min.
-  Display of speed per hour.
-  Working width of the implement.



Display of spraying pressure.



Neutral position of functions (clear).



Memory key. Calibration constants (memory).



Coding key (enter).



Dot. For decimals.



Numeric key from 0 to 9.



Boom sections (working width).

Operation and Function

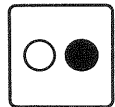



Main Switch ON/OFF for Processor Control Unit

When turning on the HARDI TRONIC, the press must last abt. 2 sec., then the TRONIC gives a short bleeping sound.

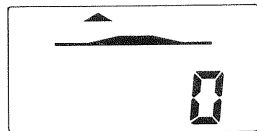
For a few seconds the display shows which sensors are connected.



- On the left display the boom becomes active, if the area switch is CORRECTLY installed.
- On the right display above the key  is shown an arrow indicating that the flowmeter is CORRECTLY fitted.
- Also an arrow above  indicates that the speed sensor is CORRECTLY fitted.
- An arrow above  indicates that the pressure transducer is CORRECTLY installed.

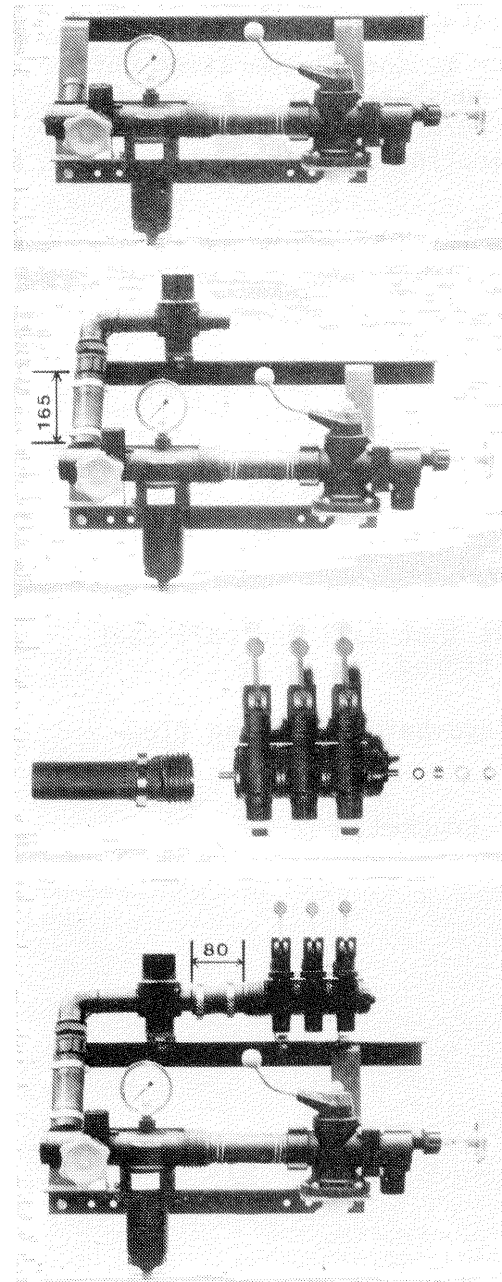

The brackets are mounted and the upper angle bolted to the lower angle.



Shorten the hose piece to 165 mm and fit it with the union nut, the hose connection and clips. Then fit the hose with clips to the connecting piece. The flowmeter is then fitted.

Assemble the distributing valves (do not forget new gaskets). The cover to be fitted with the ribs turning outwards. Fit O-ring, bushing, disc and nut consecutively.

Shorten the hose to 80 mm and fit it with clips to the flowmeter. Adapt the distribution valve brackets and bolt them to the angle piece. All assemblies are re-tightened and the hoses fitted to the operating unit.



Assembly Instructions for HARDI TRONIC 1800

Fitting of Flowmeter on BK-180 Operating Unit

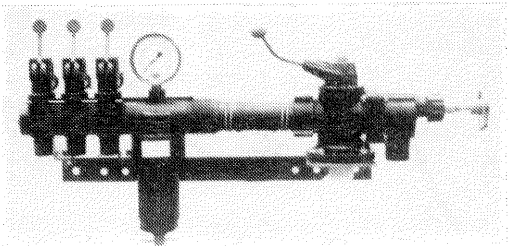

The BK-180 unit is modified.

The hoses are disconnected before modification.

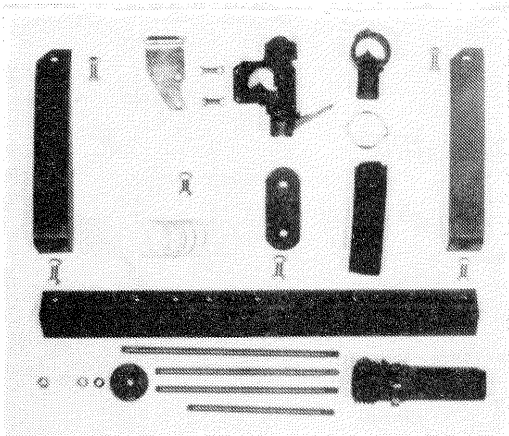

The modification set contains the necessary parts for modification. New gaskets should be fitted between all operating unit sections.

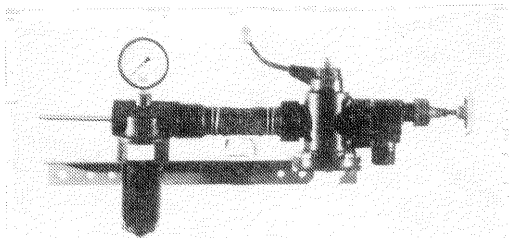

Dismantle the distribution valves. Replace the threaded rod by a shorter one (213 mm).

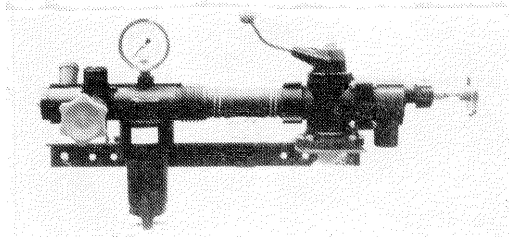

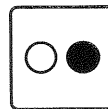

Fit the HARDI-MATIC valve just after the filter. Fix the valve by means of brackets and bolts. The connecting piece is fitted and open end fitted with cover, O-ring, disc and nut.

If the ON/OFF key is kept activated, the display will repeat the starting control procedure until it is no longer activated.

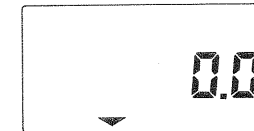
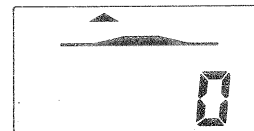

After the starting procedure, the left display shows the application rate and the right display the travel speed.



All ON/OFF functions are in OFF-position, however, except the alarm  ON/OFF function, which remembers even when the monitor is switched off. If correctly operated, the TRONIC gives a short bleeping sound, if incorrectly operated it gives a much longer bleep sound.

Spray Volume Rate

The key litre/ha has two functions. It shows the actual and the preset application rate, which is put into the memory.

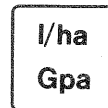

Preset of application rate. In order that the monitor can work correctly, the required application rate l/ha must be put in.

Input of the application rate, for instance 200 l/ha.

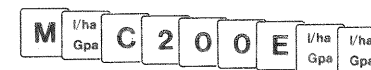

To check function



During spray work the actual application rate can be seen by pressing





Spray Volume Deviations

Deviations in application rate in percentage. If the actual application rate is smaller than the rate required, a minus is shown on the display at the extreme left.

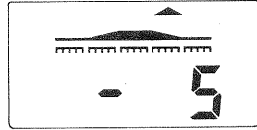

If the actual application rate is higher, no plus appears in front of the figure displayed. An acoustic alarm, which goes on or off as per wish, is functioning as an application rate guard.

The operator inputs the limit of the alarm. A percentage value from +/- 1 to +/- 9. If the alarm limit is set at +/- 5% of the application rate, the alarm goes on if the application rate deviates more than +/- 5%.

Input of the alarm limit in percentage. For instance 5% (deviation of +/- 5%).

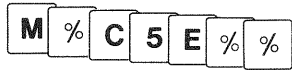

To check function



Acoustic Alarm

During spraying the monitor will function as application rate guard. The rate will continuously be measured and compared with the preset rate.

The alarm is set/turned off by pressing

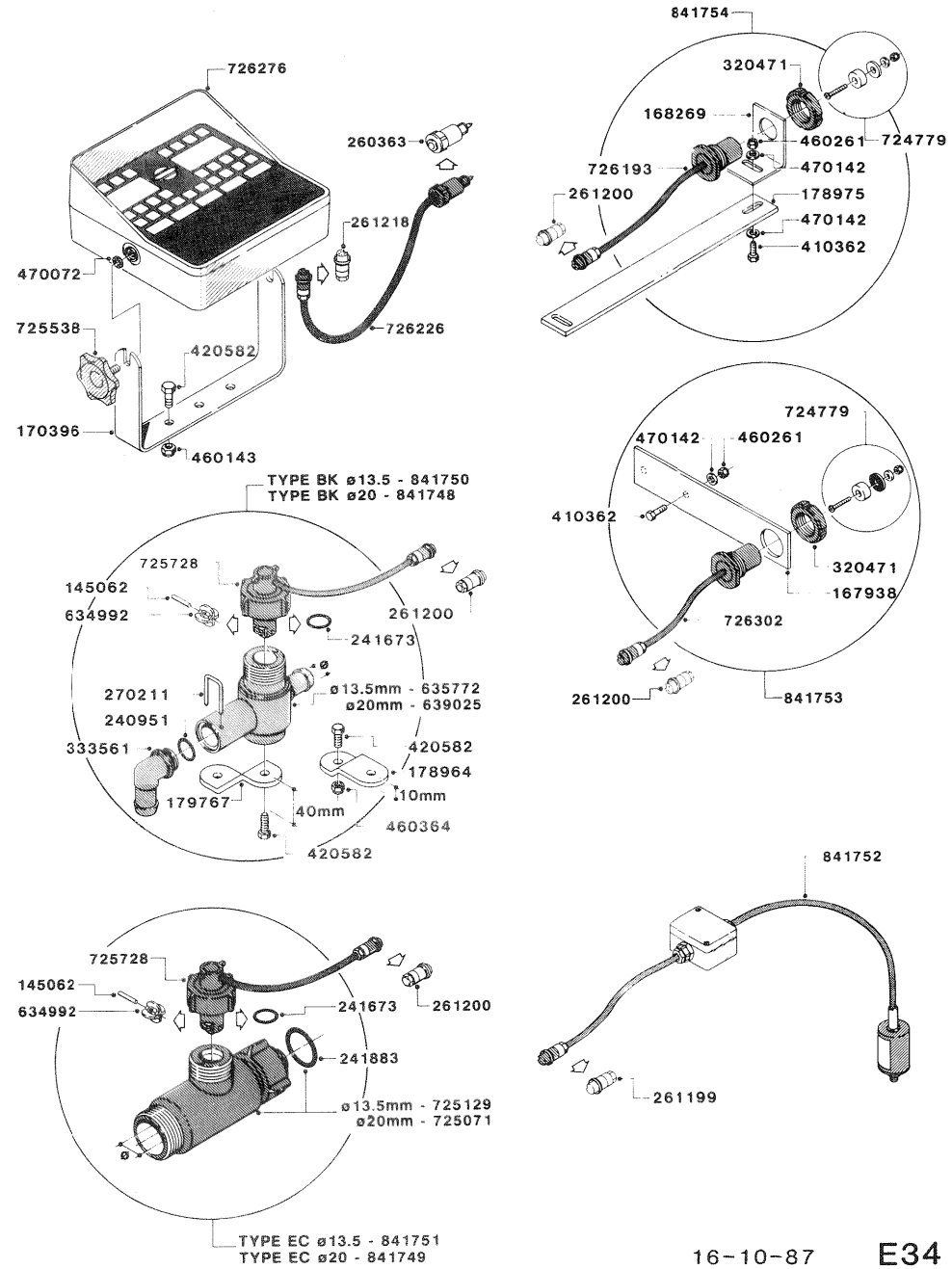



Speed Sensor

Display shows no speed (km/h mph)

- Test the speed sensor by passing a magnet in front of the sensor. Check at the same time on the right-hand display whether the HARDI TRONIC receives impulses.

Display shows variation in speed while driving evenly (km/h mph)

- Check whether mud or dirt are covering the wheel magnets and speed sensor.
- Magnets and sensor must be clean.
- Check that all magnets are there.
- Check the distance between the magnets and sensor. The distance must be between 5 - 7 mm.

Area Switch

Area switch continuous to count in off position

- Check the distance between the area switch and the magnet. The distance must be between 5 - 7 mm.
- Magnet and sensor must be cleaned for dirt.
- The sensor and magnet must be moved at least 20 mm away from each other before the area counting starts.

Pressure Transducer

Display shows no pressure



- Disconnect the pressure transducer from the boom tube. Rinse for chemical sediments, if any. Must be completely clean.
- Check wire connections in junction box on the central section for loose ends.

Memories with Two Functions

The purpose of having double function keys is currently to tell how many



- litres/gallons have been applied
- hectares/acres have been treated
- metres/miles have been driven

The purpose of double functions is for instance: Register 1 is set at neutral at the beginning of a new task, register 2 can sum up the values of a whole season or similar.

When pressing  the totally applied liquid rate is shown.  contains two memories



First press 1st memory ▼

Second press 2nd memory ▼

When pressing  the total distance driven is shown.  contains two memories:

First press 1st memory ▼



Second press 2nd memory ▼

When pressing  the total area treated is shown.  contains two memories:

First press 1st memory ▼

Second press 2nd memory ▼

Values summed up can be cancelled individually. This is done by

1st memory:  C  E 

2nd memory:    C  E 

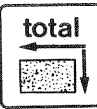

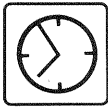



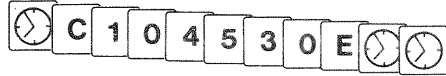

Clock Function

When pressing  the time will appear in the right-hand display.

Input of the time, e.g. 10.45.30



Stop watch function. To clear the time.  C E  



The watch is started by pressing once and stopped by pressing twice.

When pressing once on the key the clock will show.
When pressing twice the clock stops.

The clock goes on even when the display is switched off.



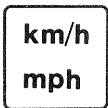

Liquid Volume Rate per Minute

When pressing on  the actual liquid volume rate per min. during spraying will show. See calibration of .



Forward Speed per Hour

When pressing on  when driving the actual forward speed per hour will show. See calibration of .

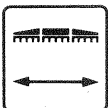

Working Width

Display of the actual working width of the sprayer or the implement. Function with two decimals is shown on the display when pressing .

The working width of the sprayer is divided into sections depending on the number of distribution valves of the operating unit.

7. Check frequently the distance between the wheel magnets and the sensor.

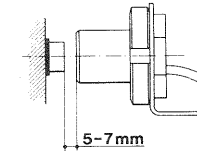

8. The pressure transducer fitted on the spray boom must be checked frequently and cleaned with caution to remove chemical deposits. Thereby the most exact measurement is obtained.



Fault finding

If the HARDI TRONIC does not operate as expected, it may be due to errors in the system or lack of maintenance.



- If a problem appears check first all the constants:



- Check on the back of the HARDI TRONIC whether the switches are correctly set.

- Check all the plugs to the HARDI TRONIC for breakage, dirt, moisture or corrosion.

- Check all wire connections out to each sensor for breakage or damage.

- Replace batteries, if necessary.

Flowmeter

Display shows no flow (l/min Gpm)

- Check that the mill-wheel can rotate easily.

- Remove the flowmeter from the casing and activate the mill-wheel by blowing or using a finger so it rotates. Check at the same time on the right-hand display whether the HARDI TRONIC receives impulses



Maintenance and Storage

The HARDI TRONIC 1800 is a precision instrument that can work without problems for many years, if just the following rules concerning maintenance and storage are kept:



1. Place all cables in order to avoid any damage. Pay special attention to wear and tear from the tractor and to any direct pull on the cable assemblies, etc.
2. When no longer in use, the instrument should be kept indoors, protected against the sun, humidity, dust, frost and heat. In cold weather the batteries lose their efficiency.
3. Avoid water or rain direct on the instrument.
4. When the spraying season is over the measuring unit of the flowmeter should be dismantled from the T-piece.

Clean the mill wheel thoroughly and test to see if it can rotate without any resistance.
5. The wheel magnets can attract magnetic materials, this must be kept clean. Earth, plants and similar must be removed from the magnets and the speed sensor.
6. During winter, where the TRONIC is not used, it is advisable to remove the batteries in order to avoid possible leakage. Or fit new batteries to avoid loss of constants.

For example, 16 m spray boom with 4 distribution valves each of 4.00 m.

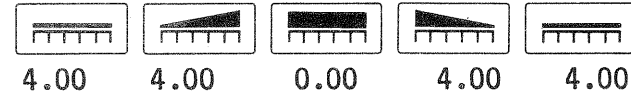

or 12 m spray boom with 3 distribution valves.

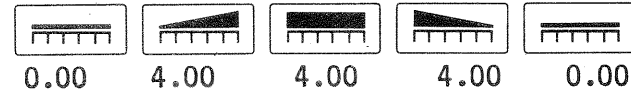

Coding of working width for e.g. 16 m boom with 4 distribution valves each of 4.00 m.

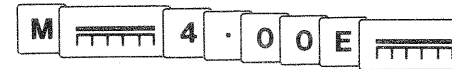

To check function M

This is done for each boom section. Each section can be coded to 2 decimals.

On the left-hand display the boom sections are shown whether spraying or not. When the flow to a section is switched off on the operating unit, the corresponding section must also be switched off on the TRONIC display. If a section is switched off, the new width is shown on the right-hand display by pressing .

It is important that the exact measurement for the boom sections are correctly coded enabling the processor control units to calculate the correct application rate, area, litre and actual working width.

Calibration

Calibration of the Flowmeter

The flowmeter is fitted in the operating unit system of the sprayer. It measures the liquid volume being sprayed out through the nozzles. In the T-piece of the flowmeter the sensor unit itself is fixed by means of a union nut.

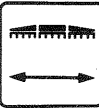

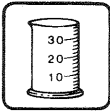

The sensor unit is provided with a mill wheel with 4 wings. Four magnet are cast into each wing. The mill wheel is rotated by the passing liquid.

Thereby the sensor gives electrical signals to the processor unit.

l/min
Gpm

Calibration of Flowmeter by Trial

This is done by measuring the spray volume rate from one or more nozzles at a given pressure.

Example:

A 16 m spray boom with 32 nozzles (nozzle distance 50 cm). The volume of each nozzle is 1.59 l/min at a pressure of 3 bar. The total spray volume rate to the boom per minute will then be 1.59×32 nozzles = 50.88 l.

The nozzle volume l/min. can be looked up in a table, but a measurement made by means of a measuring jug from one or more nozzles will be a better method to find the volume per nozzle and thereby the spray volume rate l/min. of the boom.

The calibration is made by pumping clean water to the spray boom at a preset adjustment. Pressure and nozzle are correct according to volume in litre.



Calibration by tests e.g. 50.88 l/min. total spray volume rate to the spray boom.



The calibration is started. A constant flow must pass through the flow sensor. The left-hand display shows the frequency of impulses from the flow sensor. The impulses must be constant before coding the application rate in litre.

Code 50.88 l/min.

When using the area switch the below routine is followed.

- Switch off the TRONIC 
- Dismount plug from flowmeter
- Fit plug from area switch
- Switch on the TRONIC 
- Key working width of implement 

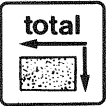

When this measuring must stop, the magnet and sensor must be precisely opposite each other. The distance between sensor and magnet should be 5 to 7 mm.

When area counting is started, the magnet must be moved at least 20 mm away from the middle of the sensor.

The area switch can be placed at

- the lift function of the tractor
- coupling lever of the PTO outlet
- opening/closing function of an implement
- lifting/lowering function of a trailed implement

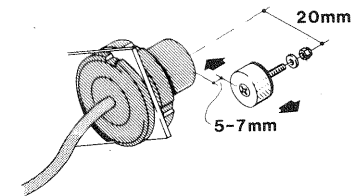

Pressure Transducer

For measurement of the spray pressure on the boom a pressure transducer is fitted at the end of a boom tube.

Choice the boom tube at the central part and screw on the connecting box to the central frame. Grease the O-ring before fitting the pressure transducer to the nozzle tube.

It is important to connect the tractor battery to the 12 V supply in order that the pressure transducer can register the pressure.

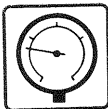



Calibration of Pressure Transducer by Keying

Keying of a pre-known constant, e.g. 3050.

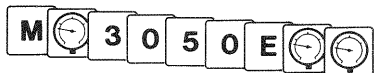

To check function



WHEN CALIBRATION AND INPUT OF THE VALUES HAVE BEEN MADE, THE SWITCH NO. 4 IS SET AT ON-POSITION. THE CONSTANTS ARE LOCKED AND CANNOT BE CANCELLED OR CHANGED BEFORE THE SWITCH AGAIN IS SET IN OFF-POSITION.



Table for Recording of Constants

Tyre size	Constant km/h	Spray chemical	Constant l/min	Nozzle no.

Optional Extras



Area Switch

The area switch is used in connection with other types of implements and can be fitted at various places according to the implement.

The area switch is necessary for controlling the start and finish function of the area measuring.

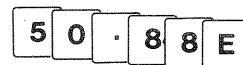

The calculation unit calculates the calibration constant. The constant is shown on the right-hand display.

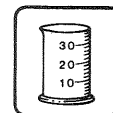

Reading, control of the calibration constant



Calibration of Flowmeter by Trial

In case of input of a constant known in advance of e.g. 606.

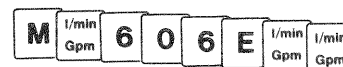

To check function

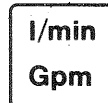

Calibration of Speed Sensor

The speed sensor fitted close to a wheel disc is passed by magnets fixed to the wheel disc. At each rotation of the wheel the speed sensor gives electrical signals corresponding to the number of magnets. Two different calibration methods can be used.

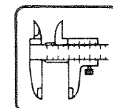

Calibration of Speed Sensor by Calculation

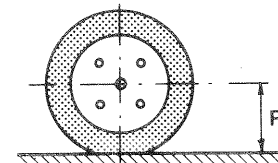

R = Rolling radius is measured in metre and inserted in a formula.

$$\frac{N \times 1000}{2 \times 3,14 \times R} = \text{Calibration constant}$$

N = The number of magnets fitted on the rim.

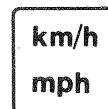

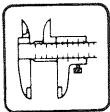

Ex:

N = 4 magnets

$$\frac{4 \times 1000}{2 \times 3.14 \times 0.485} = \frac{4000}{3.07} = 1313$$

R = 0.485 m

km/h
mph

Input of calibration constant.

M km/h mph 1 3 1 3 E km/h mph km/h mph

To check function

M km/h mph



IMPORTANT: Check frequently the tyre pressure. In case of much wear, calibration should be done frequently. If 4-wheel drive is connected during measurement of the wheel circumference, the 4-wheel drive must also be connected during work.

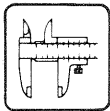

Calibration of Speed Sensor by Trial

This calibration takes place by driving a pre-measured distance. The distance may be between 2 trees, milestones on the road or similar.

km/h
mph

NB: The distance should be at least 75 metres.

EXAMPLE

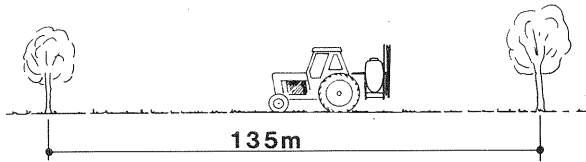

A known distance is e.g. 135 m (without decimals). At starting point the following is put in.

M km/h mph C E km/h mph

The distance is driven. Then the 135 m is put in.

1 3 5 E km/h mph

The processor unit calculates the calibration constant. Can be seen on the right-hand display

km/h mph

km/h
mph

Reading/control of the constant

M km/h mph

Calibration of Pressure Transducer

The pressure transducer which is fitted in the liquid system at the boom, updates the actual pressure once a second.



Calibration of Pressure Transducer by Trial

The calibration constant of the pressure transducer is calculated from two calibration points. Two pre-decided pressure ranges, for example 2 bar and 8 bar.

The calibration is started with clean water in the sprayer and the pressure set at 2 bar on the pressure gauge of the operating unit. Then the following must be done.

M C E

On the left display a figure of three digits is shown. When the figure appears without too much variation, the figure 2 for 2 bar is coded.

2 E

Instantly, the pressure is readjusted up to 8 bar on the operating unit. A new figure of 3 digits is shown on the left-hand display. The figure 8 is coded, when the figure of three digits appears calmly.

8 E

On the right display you can now see the calibration constant, which should be around 3050.

When pressing  the actual pressure is shown.

To check function.

M 